

MUTOH

**OPERATION
MANUAL**

MUTOH Status Monitor

Read This Manual Before Using The Application

Contents

- Contents 1
- 1. Introduction 1-1
 - 1.1. Summary 1-1
 - 1.2. Environment..... 1-2
 - 1.3. Trademarks Mentioned in this Manual 1-2
 - 1.4. Supported Application Version 1-3
 - 1.5. Supported Language 1-3
- 2. Install / Uninstall 2-1
 - 2.1. Installation..... 2-1
 - 2.2. Uninstallation 2-4
 - 2.3. Setting Exceptions in Windows Firewall Settings..... 2-4
- 3. Initial Setting..... 3-1
 - 3.1. Introduction 3-2
 - 3.2. Service List 3-3
 - 3.3. Proxy Setting 3-4
 - 3.3.1 Proxy Setting Manually 3-5
 - 3.4. MUTOH Club Login..... 3-6
 - 3.4.1 MUTOH Club Login Error..... 3-7
 - 3.5. MUTOH Club Login Setting 3-8
 - 3.6. Report Mail Setting 3-9
 - 3.6.1 Mail Setting(General) 3-10
 - 3.6.2 Mail Setting(SMTP) 3-11
 - 3.7. e-mail address Setting 3-12
 - 3.8. Default Setting Confirmation 3-13
 - 3.9. Printer Registration 3-14
 - 3.9.1 Register the printer information..... 3-15
 - 3.9.2 Completion..... 3-19
 - 3.9.3 Registering several printers 3-21
 - 3.9.4 Change registered printer information..... 3-22
 - 3.10. Initial setting completed 3-23
- 4. Start/Exit..... 4-1
 - 4.1. Start 4-1

4.2.	Task Tray Icon.....	4-1
4.3.	Title bar	4-2
5.	MSM Setting.....	5-1
5.1.	Setting.....	5-1
5.2.	Help	5-2
5.2.1	Initialization	5-3
5.2.2	Version	5-4
6.	Menu.....	6-1
6.1.	User Setting Information	6-2
6.2.	Menu.....	6-3
6.2.1	Date and Time Update	6-4
6.2.2	Media Type Edit	6-5
6.2.3	Firmware Update.....	6-6
6.2.4	Check the Latest Firmware	6-13
6.2.5	Printer Information Backup.....	6-23
6.2.6	Printer Information Upload	6-23
6.2.7	Exit (MSM Minimize)	6-23
7.	Status monitor	7-1
7.1.	Printer Information	7-2
7.1.1	Display the Details Information.....	7-3
7.2.	Detail Information.....	7-4
7.3.	Status Information	7-5
7.4.	Smart/C Information.....	7-6
7.4.1	Update the Smart/C with MB-Web.....	7-7
7.4.2	Update the Smart/C with the Update File (MSCF)	7-8
7.4.3	Update the Smart/C with S/C Card	7-9
7.4.4	Smart/C Information.....	7-10
7.5.	Heater Information	7-12
7.5.1	Heater Information	7-12
7.5.2	Blower Heater Information	7-13
7.6.	Head/Cartridge Information.....	7-14
7.7.	S/C Card Information	7-15
7.7.1	Format check	7-16
7.7.2	S/C Card Recovery	7-17
7.8.	Media Information	7-18
7.9.	Print Information	7-19

8. Activation	8-1
8.1. Execute Activation via the Internet	8-1
8.2. Execute Activation By Entering "Activation Code"	8-4
9. Report Mail	9-1
9.1. Printer Setup	9-2
9.2. Sending Mail Address Setting	9-3
9.3. Sending Mail Function Setting	9-4
9.3.1 Send Mail Function	9-5
9.4. Mail Content Setting	9-6
9.4.1 Threshold Valuet	9-7
9.5. List of Settings	9-8
10. ColorVerify	10-1
10.1. History	10-2
10.1.1 Printer Infomation	10-3
10.1.2 History List	10-3
10.1.3 Detail Information	10-4
10.2. Color Verify	10-11
10.2.1 Configuration	10-12
10.2.2 Preparing the printer	10-13
10.2.3 Printing configuration information	10-14
10.2.4 Waiting for measurement data to be received	10-14
10.2.5 Printing color target	10-14
10.2.6 Waiting for the instrument to be attached	10-14
10.2.7 Waiting for the measurements to complete	10-15
10.2.8 Measuring	10-15
10.2.9 Receiving the instrument to be detached	10-15
10.2.10 Waiting for the instrument to be detached	10-16
10.2.11 Printing color verify result	10-16
10.2.12 Waiting for color verify result	10-17
10.2.13 End	10-18
10.2.14 Stop	10-19
10.2.15 Windows Firewall	10-19
11. VSM Mobile	11-1
11.1. VSM Mobile Setting	11-2
11.1.1 VSM Mobile Information	11-3
11.1.2 MSM Setting	11-8

12. Print History	12-1
12.1. Search Condition	12-2
12.2. Print History List.....	12-3
12.3. Detail Information.....	12-4
12.3.1 Print Information.....	12-5
12.3.2 Graph.....	12-6
12.4. Statistics Information.....	12-7
12.4.1 Statistics Information.....	12-8
12.4.2 Graph.....	12-9
12.5. Setting	12-10
12.6. Cost Setting	12-11
12.6.1 Ink.....	12-12
12.6.2 Media.....	12-13
12.6.3 Other.....	12-14
12.7. Initialization.....	12-15
12.8. Export	12-16
12.8.1 Manual.....	12-17
12.8.2 Auto	12-17
13. Remote Panel	13-1
13.1. VJ-628/628X/628MP.....	13-1
13.1.1 Remote Panel.....	13-1
13.1.2 Printer Status	13-2
13.1.3 Printer Control.....	13-6
13.1.4 Media Setting.....	13-44
13.1.5 Advanced Setting.....	13-102
13.1.6 Other Settings.....	13-106
13.1.7 Plug Lifetime	13-111
13.2. VJ-1x38(W)X/1x24(W)X/1628X/2638X/1938TX/1638UH(2)/ 1948WX/1324XS/1638UR(2)/162xMH.....	13-113
13.2.1 Remote Panel.....	13-113
13.2.2 Printer Status	13-114
13.2.3 Settings.....	13-115
13.2.4 Printer Control.....	13-116
13.3. VJ-426UF / 626UF/XPJ-461UF/661UF/1462UF	13-121
13.3.1 Remote Panel.....	13-121
13.3.2 Printer Status	13-123

13.3.3	Printer Control.....	13-124
13.3.4	Media Setting.....	13-134
13.3.5	Advanced Setting.....	13-147
13.3.6	Plug Lifetime	13-154
13.4.	XPJ-1641SR/1682SR/16x2WR/1341xR-P/1641SR-P/ 1682SR-P/HA-1642	13-156
13.4.1	Remote Panel.....	13-156
13.4.2	Printer Status	13-157
13.4.3	Printer Control.....	13-160
13.4.4	Media Setting.....	13-175
13.4.5	Advanced Setting.....	13-187
13.4.6	Other Setting.....	13-192
14.	MUTOH Print Server	14-1
14.1.	Notes for Use.....	14-1
14.1.1	Preparation	14-1
14.1.2	Software RIP Setup.....	14-2
14.1.3	Windows Firewall Exception Setting	14-3
14.1.4	Notes	14-8
14.2.	Hardware Requirements.....	14-9
14.2.1	Recommended Hardware Requirements.....	14-9
14.2.2	Example of Network Configuration to use MPS	14-11
14.3.	How to Use MPS	14-13
14.3.1	Enable MPS.....	14-13
14.3.2	Start MPS.....	14-13
14.3.3	MPS Settings Confirmation Dialog.....	14-14
14.3.4	Select MPS Service Number.....	14-14
14.3.5	MPS Settings	14-15
14.3.6	MPS Main Screen	14-15
14.4.	How to Configure MPS Settings	14-16
14.4.1	MPS Service Number	14-16
14.4.2	MPS Setting.....	14-18
14.4.3	Main Screen.....	14-19
14.4.4	MPS Information	14-20
14.4.5	Restart MPS.....	14-21
14.5.	Restrictions	14-22
14.5.1	When RIP and Spectrophotometer (SPECTROVUE) are used in combination	14-22

14.6.	Troubleshooting	14-22
14.6.1	Troubles for Installation	14-23
14.6.2	Troubles related to Printing	14-25
15.	MiniMSM	15-1
15.1.	How to start.....	15-1
15.2.	Main Screen(For models other than XPJ-1462UF).....	15-2
15.2.1	Status Information	15-3
15.2.2	S/C Information	15-3
15.2.3	Smart/C Information.....	15-4
15.2.4	Heater Information	15-4
15.2.5	Remote Panel	15-5
15.2.6	Printer Information	15-6
15.2.7	MiniMSM Settings	15-6
15.3.	XPJ-1462UF	15-7
15.3.1	Setting screen (Cleaning)	15-8
15.3.2	Setting screen (Nozzle Check).....	15-9
16.	VerteLith.....	16-1
17.	List of Supported Functions for Each Machine Model.....	17-1
18.	Error Code List	18-1
18.1.	Printer Status	18-1
18.2.	Printer Registration	18-6
18.3.	Remote Panel.....	18-10
18.4.	Smart/C	18-11
18.4.1	S/C Card	18-11

1. Introduction

This document describes the operating instruction of MUTOH Status Monitor (hereinafter referred to as MSM).

1.1. Summary

The MSM supports the following functions.

1. Date and Time Update
2. Edit the name of user media
3. Update firmware
4. Check current firmware
5. Update the Smart/C
6. Status Monitor
7. Activation
8. Report Mail
9. Color Verify
10. VSM Mobile

NOTE

- The supported functions of MSM vary depending on the model.
- The latest information for MSM is posted on MUTOH Club. Please login regularly to check the update.
- Please note that some descriptions in this document may be the descriptions for previous VSM (ValueJet Status Monitor).

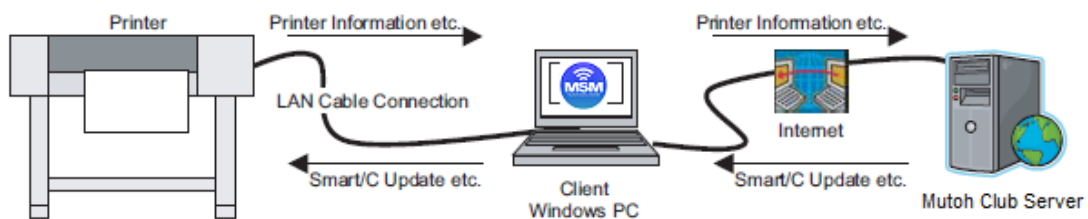

1.2. Environment

To use the MSM, the following minimum requirements must be met.

- **Windows PC**

1. Windows 10 or Windows 11. ^{*1}

When the above OS support ends, the operation on MSM cannot be ensured.

2. Log on as an administrator.
3. Can connect to the printer via LAN port (RJ-45).
4. Screen resolution of 1024x768 or higher (recommended).
5. Install the latest Internet Explorer and connect to the Internet ^{*2}.

- **LAN cable** ^{*3}

^{*1}: 32bit(x86)OS

^{*2}: The MSM operation is not guaranteed without Microsoft Edge (recommended browser).

^{*3}: The preferred method of network connection for the printer should be via hub (Straight Cable).

NOTE

- The latest information for MSM is posted on MUTOH Club. Please login regularly to check the update.
-

1.3. Trademarks Mentioned in this Manual

- Windows 10, Windows 11 and Microsoft Edge are registered trademarks or product names of Microsoft Corporation.
- Android market is a trademark or registered trademark of Google Inc.
- Other company and product names may be registered trademarks or product names.

1.4. Supported Application Version

<i>Application</i>	<i>Version</i>
Application Version	8.22
MUTOH Print Server(MPS) Version	1.4.0
MUTOH LFP Finder Version	2.3.0

1.5. Supported Language

<i>Language</i>	
Japanese	German
English	Spanish
Korean	Dutch
Chinese	Italian
French	Portuguese

2. Install / Uninstall

2.1. Installation

Use the installer to install MSM. If MSM is already installed, this installation procedure is not required.

1. Execute the "¥ENG¥Setup.exe" file in the distributed folder, which is for English.

The install wizard starts up. Follow the procedure below to install the MSM.

2. If the essential component for MSM "VC++ Run-time Library" is not installed, you will need to install the component.

Click the "Install" button to complete the installation.

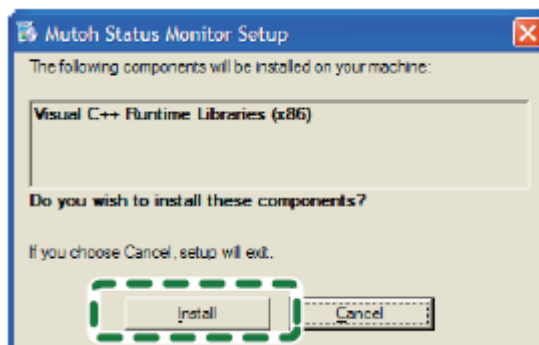

3. Click "Next" button.



4. To accept the terms below, click "I Agree", then "Next".

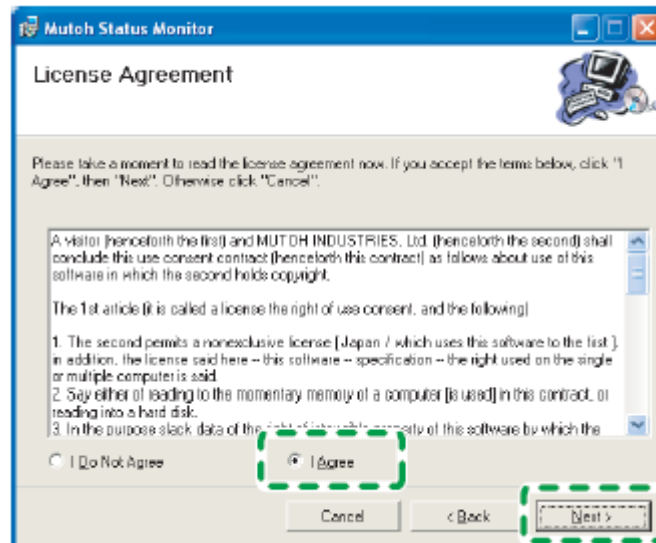

5. Select the folder to install the MSM. Please proceed to the installation with the default folder or a folder you created. In addition, select the installation user.

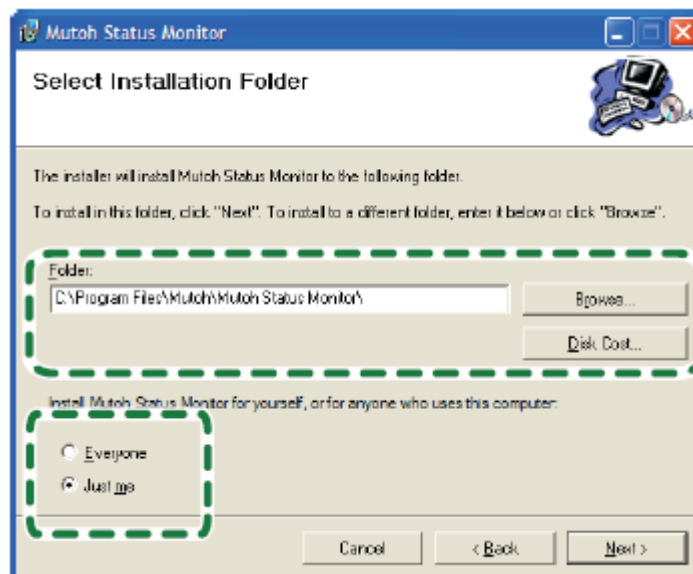

- 6. To continue the installation, click "Next" button.

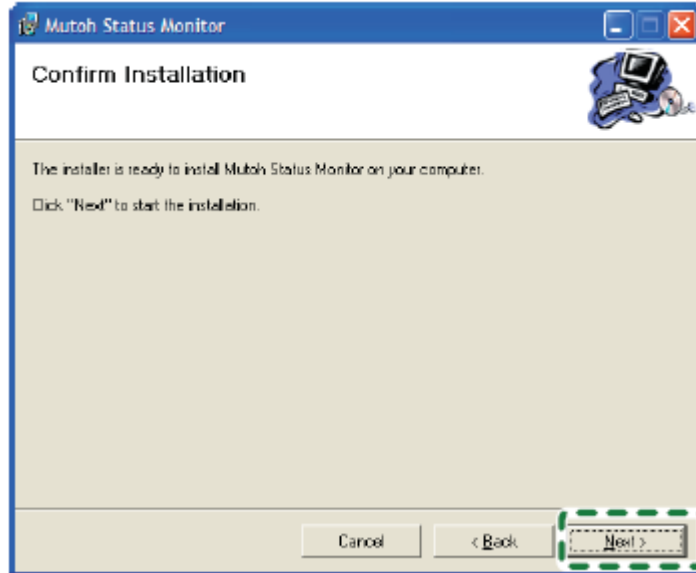

- 7. The installation is complete. Click "Close" button.

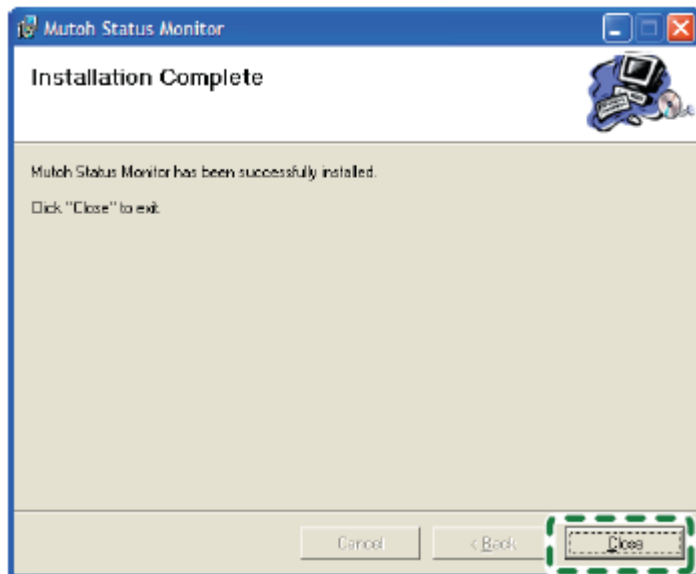

2.2. Uninstallation

Select the "Mutoh Status Monitor" from the "Add or Remove Programs", and click "Remove" button.

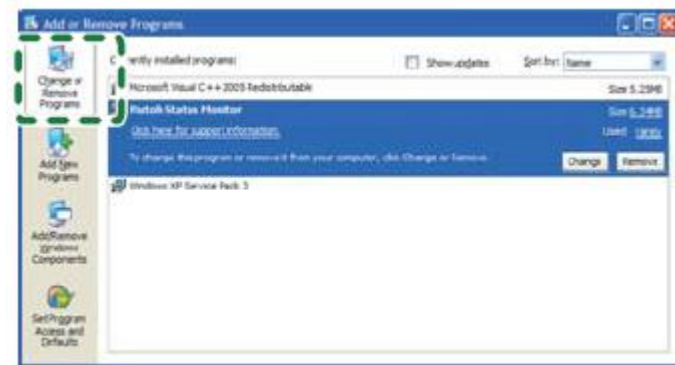

NOTE

- The MSM can be uninstalled by executing the "Setup.exe". In that case, select the "Remove MUTOH Status Monitor" to execute the uninstallation.

2.3. Setting Exceptions in Windows Firewall Settings

If you use Windows Vista or later as the OS, you need to add MSM to the exceptions list for Windows Firewall.

NOTE

- *This procedure is for Windows Vista.
- If you use virus security software other than Windows Firewall, you may need to make the settings changes to the software. Contact the software vendor for the setting procedure.

Follow the procedure below.

1. Click the Start button and then click [Control Panel].
*The Control Panel window will be displayed.
2. Click "Allow a program through Windows Firewall".

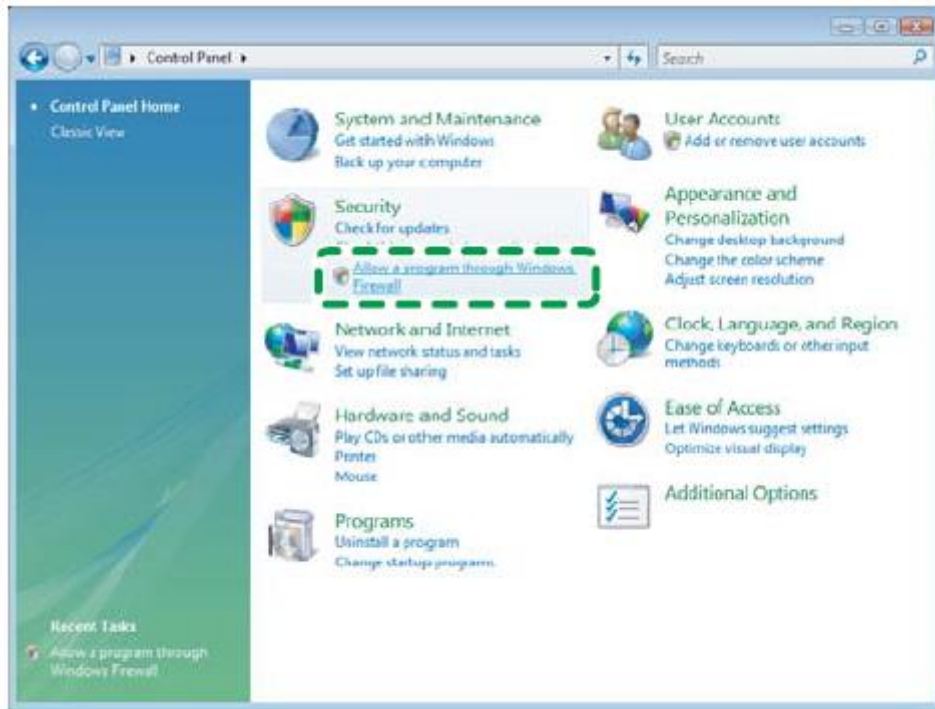

3. When the Windows Firewall Settings window is displayed, select the Exceptions tab and click the Add program button.

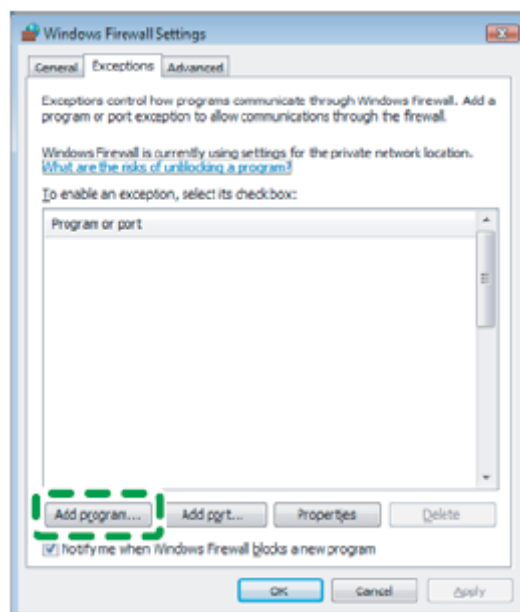

- When the Add a Program window is displayed, click the Browse button.

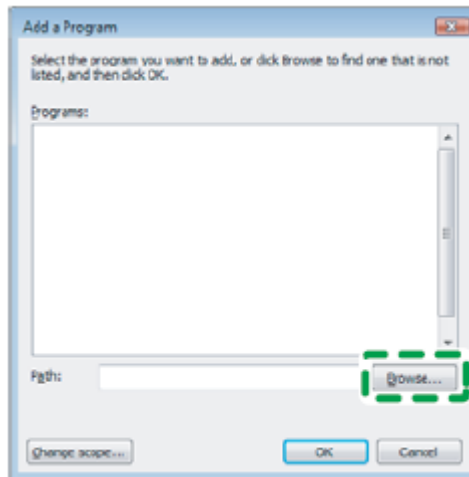

- When the Browse window is displayed, select MSM.exe where the MSM is installed and click the Open button.

NOTE

- MSM.exe is installed by default into the following directory:
Program Files>Mutoh>Mutoh Status Monitor

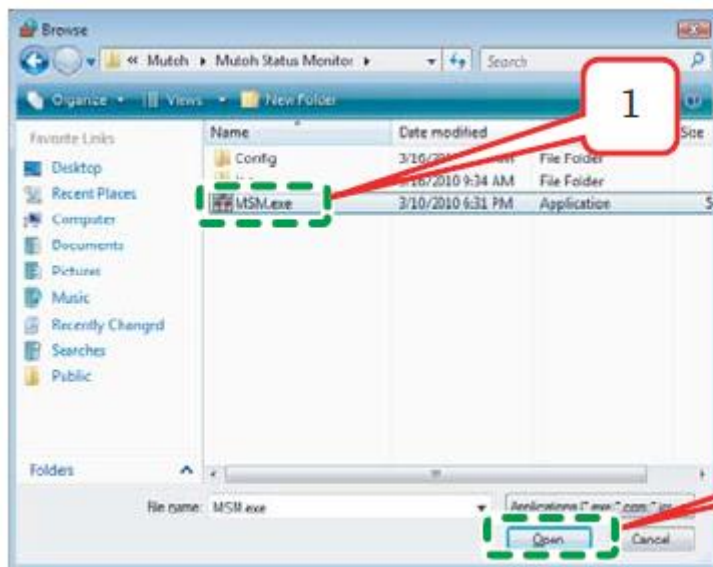

- 6. Make sure that MSM.exe is added and click the OK button.

*The Windows Firewall Settings window will be displayed.

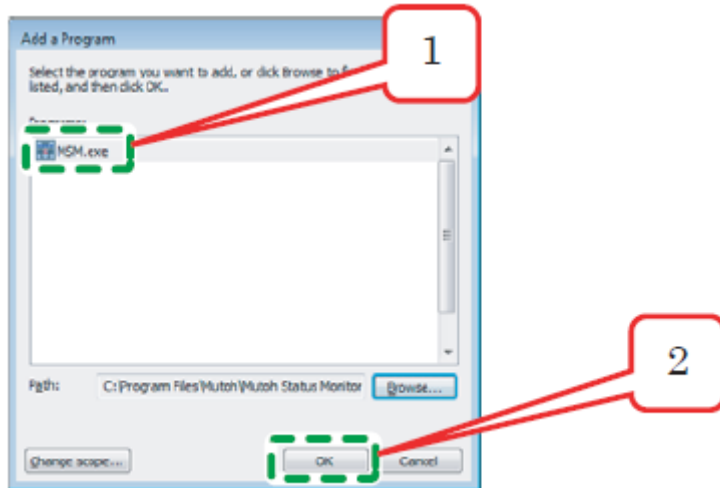

- 7. Confirm that MSM.exe is added in the Windows Firewall Settings window and click the OK button.

*Finish the setting.

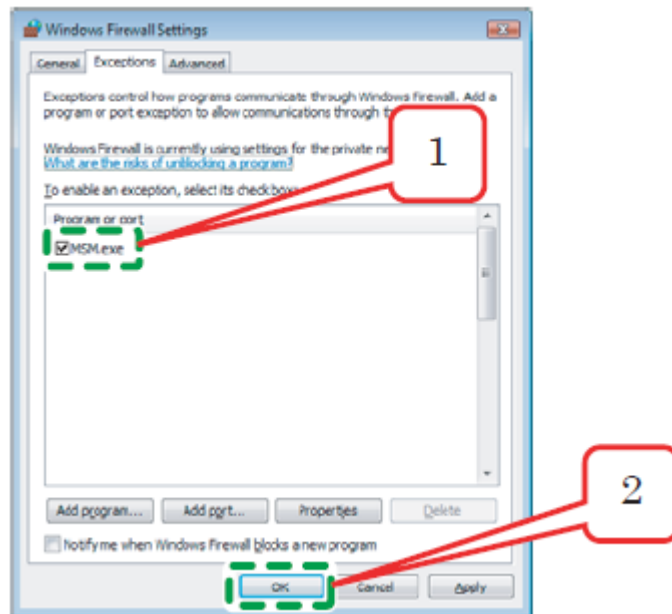

3. Initial Setting

Perform the initial setting for the MSM.

"Default setting Wizard" dialogue will be displayed when the MSM is started for the first time.

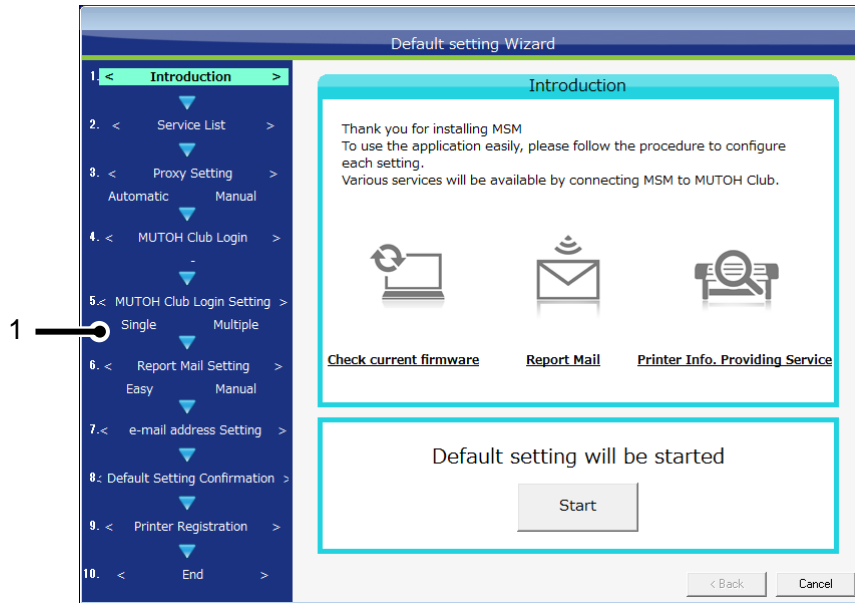

No.	Name	Description
1	Menu	Setting contents to be specified in the initial setting Follow the procedure to configure the setting.

NOTE

- The initial setting cannot be canceled on the way.
Please complete the setting.

3.1. Introduction

This window will be displayed at the first time to use MSM.

Check the contents, and click "Start" button.

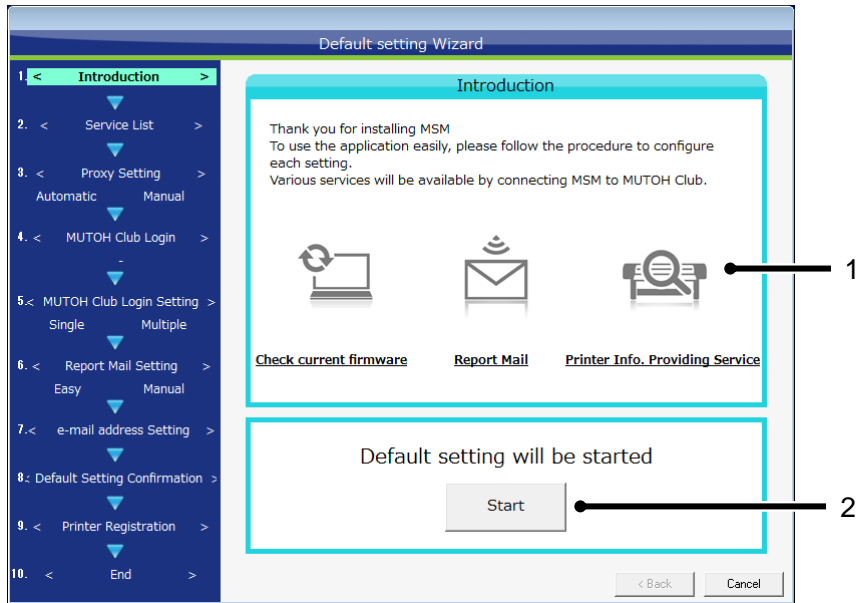

No.	Name	Description
1	Service List	List of services to be available for users by connecting the MSM to MUTOH Club.
2	Start	Start the initial setting.

3.2. Service List

Specify the contents of MUTOH Club service to use.

Select the service to use, and click "Next" button.

NOTE

- To use MUTOH Club service, need to log into MUTOH Club through the Internet.

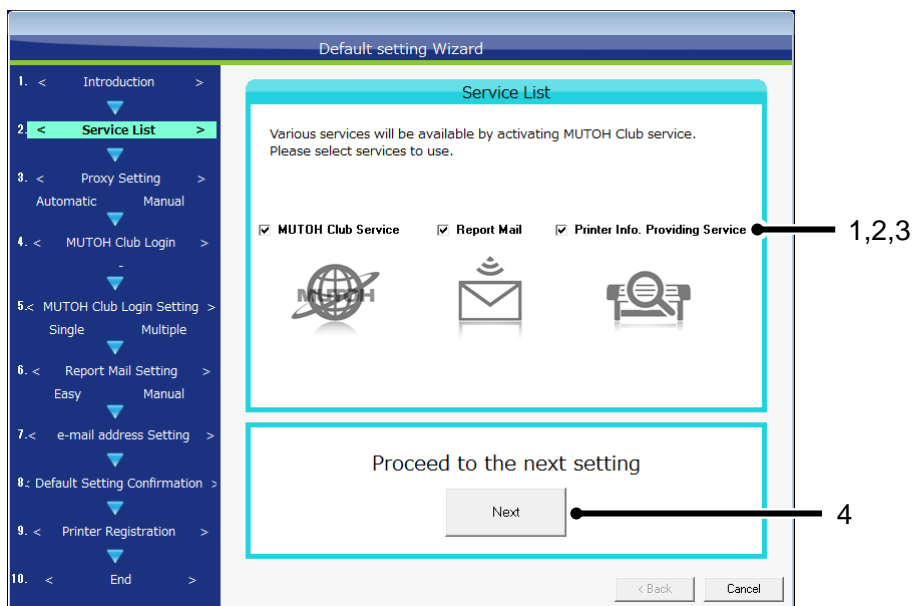

No.	Name	Description
1	MUTOH Club Service	Select the checkbox to use MUTOH Club service. When the MUTOH Club service is unchecked, the following services will not be available.
2	Report Mail	Select the checkbox to use the service to send report mail to the e-mail address specified in MSM.
3	Printer Information Providing Service	Select the checkbox to use the service to back up the printer information to MUTOH Club from MSM, and check the printer information through MUTOH Club.
4	Next	Proceed to the next setting.

3.3. Proxy Setting

To use the proxy server according to the internet environment, please configure the setting.

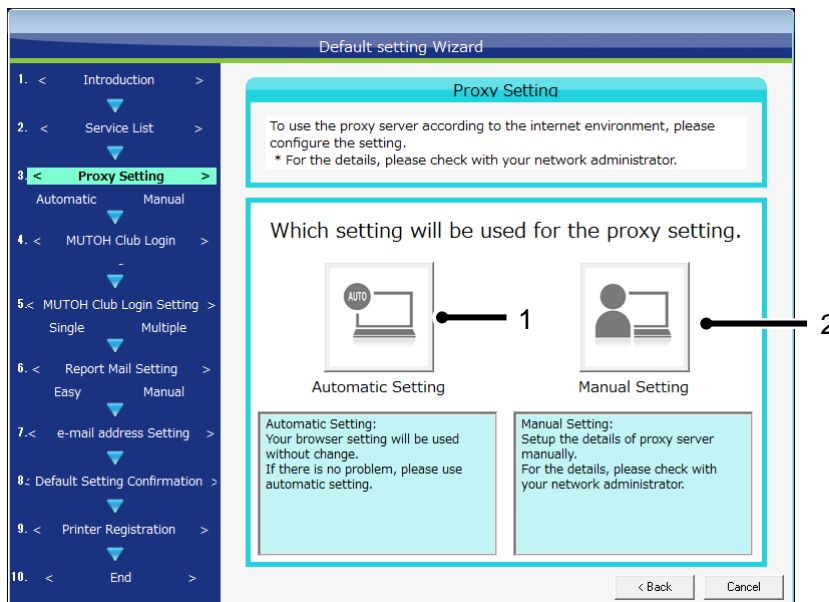

No.	Name	Description
1	Automatic Setting	Your browser setting will be used without change. If there is no problem, please use automatic setting.
2	Manual Setting	Setup the details of proxy server manually. For the details, please check with your network administrator.

3.3.1 Proxy Setting Manually

Configure the proxy setting manually.

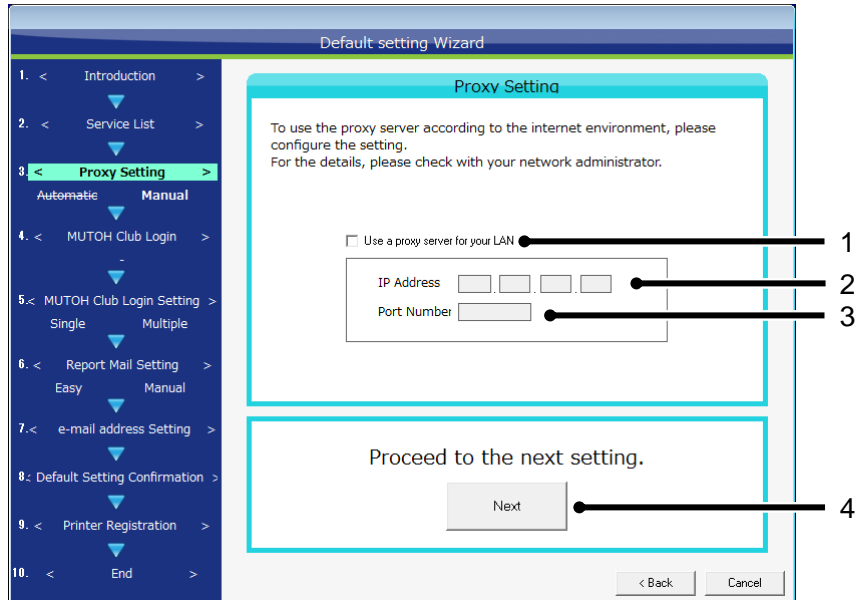

No.	Name	Description
1	Use a proxy server for your LAN	Check the box to use the proxy server, and enter the IP address and port number.
2	IP Address	Enter the IP address of proxy server.
3	Port Number	Enter the port number of proxy server.
4	Next	Proceed to the next setting.

3.4. MUTOH Club Login

Log into MUTOH Club.

Please enter the login ID and password that were specified for user registration.

NOTE

- To use MUTOH Club service, need to log into MUTOH Club through the Internet.

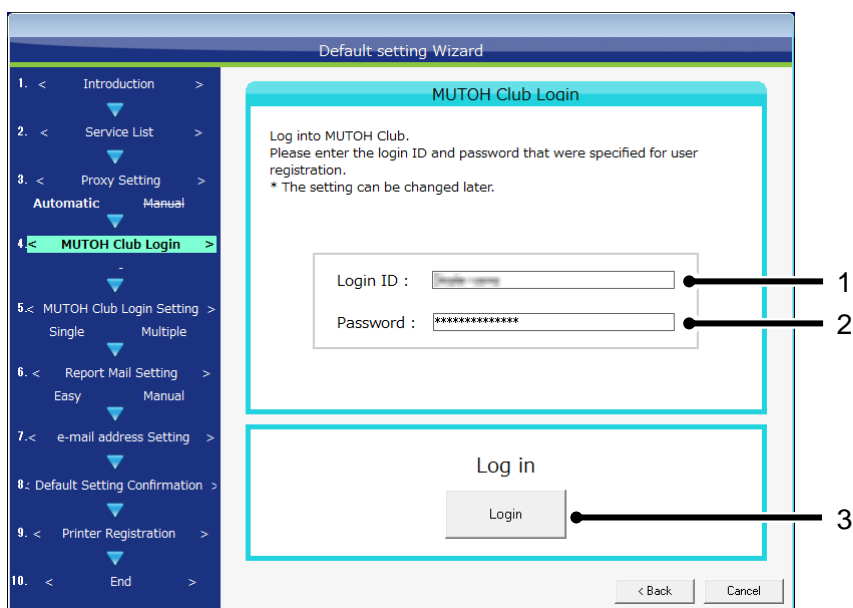

No.	Name	Description
1	Login ID	Enter the login ID for MUTOH Club.
2	Password	Enter the password for MUTOH Club.
3	Login	Enter the login ID and password to log into MUTOH Club.

3.4.1 MUTOH Club Login Error

If a wrong login ID or password is entered, or have trouble to connect the Internet, a login error will occur. Check the login ID, password and the Internet connection to log into MUTOH Club again.

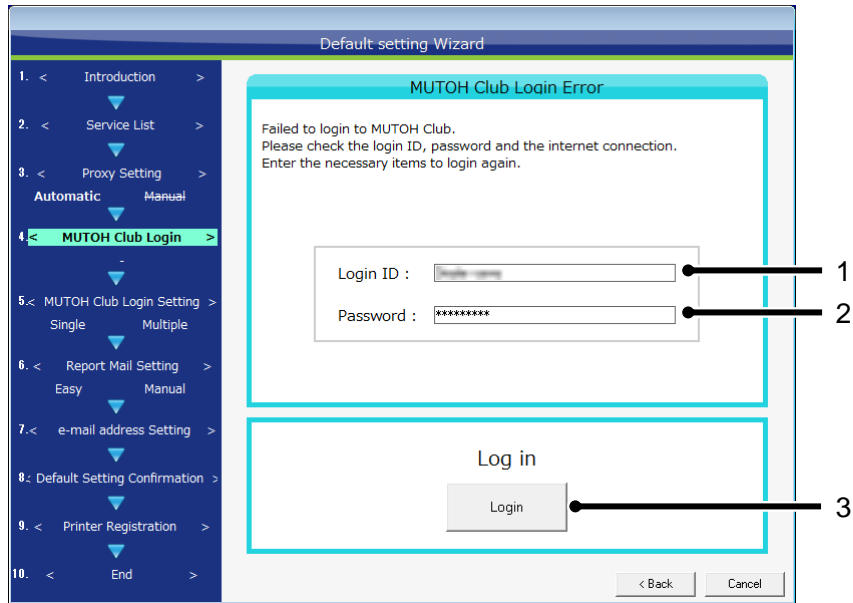

No.	Name	Description
1	Login ID	Enter the login ID for MUTOH Club.
2	Password	Enter the password for MUTOH Club.
3	Login	Enter the login ID and password to log into MUTOH Club.

3.5. MUTOH Club Login Setting

Please specify the method to login to MUTOH Club.

This setting will be the method to login to MUTOH Club from now.

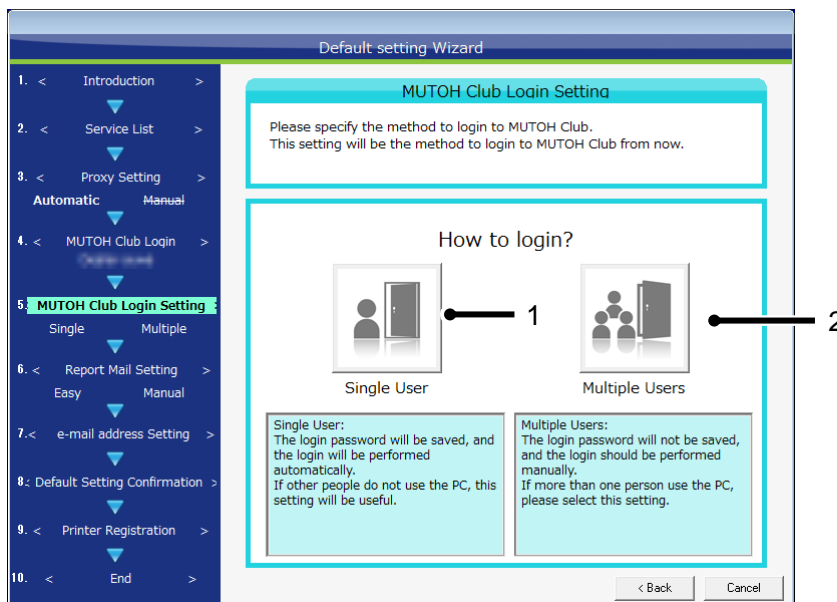

No.	Name	Description
1	Single User	The login password will be saved, and the login will be performed automatically. If other people do not use the PC, this setting will be useful.
2	Multiple Users	The login password will not be saved, and the login should be performed manually. If more than one person use the PC, please select this setting.

3.6. Report Mail Setting

Specify the mail notification system for the report mail function.

Please select the system according to your e-mail environment.

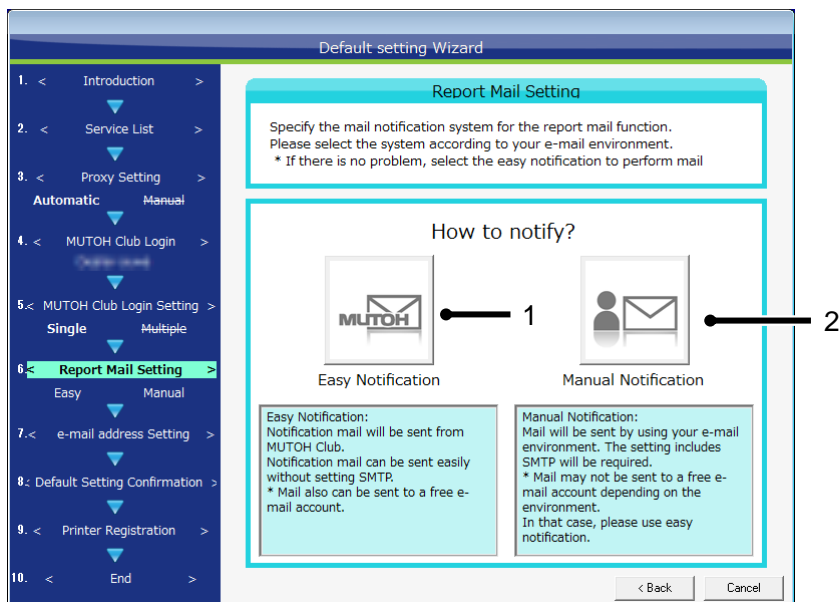

NOTE

- For the report mail functions, refer to "9.Report Mail".

3.6.1 Mail Setting(General)

If the report mail is set to manual notification, enter the user information to send mails.

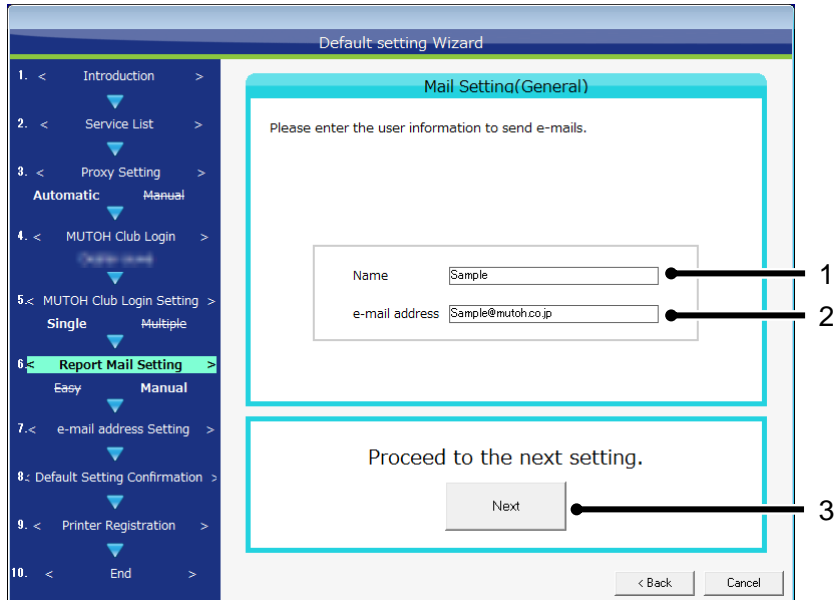

No.	Name	Description
1	Name	Enter the name to corresponding to the mail address for sending.It will be displayed by the mail software for receiving.
2	e-mail address	Enter the mail address for sending.
3	Next	Proceed to the next setting.

3.6.2 Mail Setting(SMTP)

Set up the SMTP.

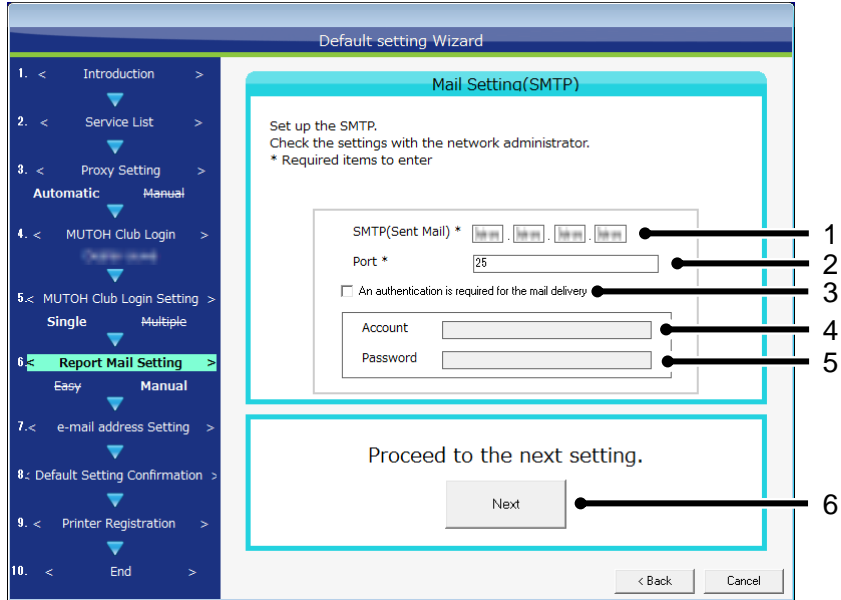

No.	Name	Description
1	Name	Enter the IP address of the mail server for sending.
2	Port	Enter the port number to be used for the connection with SMTP server. Usually, please set the default value "25" port. * Please change the setting according to the SMTP server in use.
3	An authentication is required for the mail delivery	Check the box when the authentication for SMTP server is necessary. Then enter the 4. account and 5. password.
4	Account	Enter the authentication account for the SMTP server.
5	Password	Enter the authentication password for the SMTP server.
6	Next	Proceed to the next setting.

NOTE

- For the setting contents, please check with your network administrator.

3.7. e-mail address Setting

Please register the e-mail address to be used for report mail function.

Perform "Send Test Mail" to check the mail sending condition.

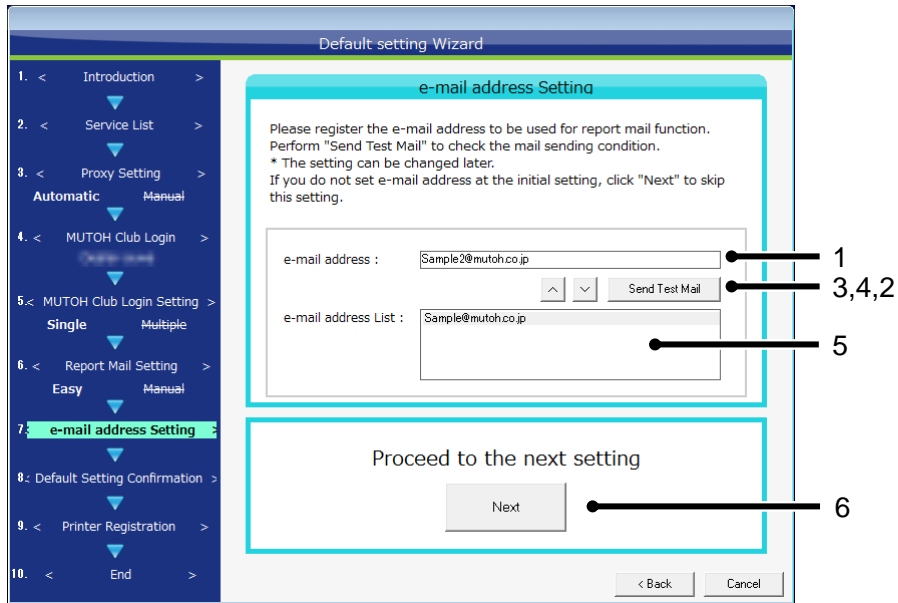

No.	Name	Description
1	e-mail address	Enter the mail address for receiving to be added.
2	Send Test Mail	Send a test mail to the address entered in "1. E-mail Address (added). * This will not be valid until other settings complete.
3	Delete Mail Address	To delete the registered e-mail address for receiving, select and click the mail address to delete.
4	Add Mail Address	Register the mail address for receiving entered in "1. E-mail Address".
5	Registered Mail Address	The registered mail address for receiving will be displayed.
6	Next	Proceed to the next setting.

3.8. Default Setting Confirmation

Please check the contents of initial setting.

If there is no problem with the settings click "Save" button.

To change the settings, click the setting items and change the settings.

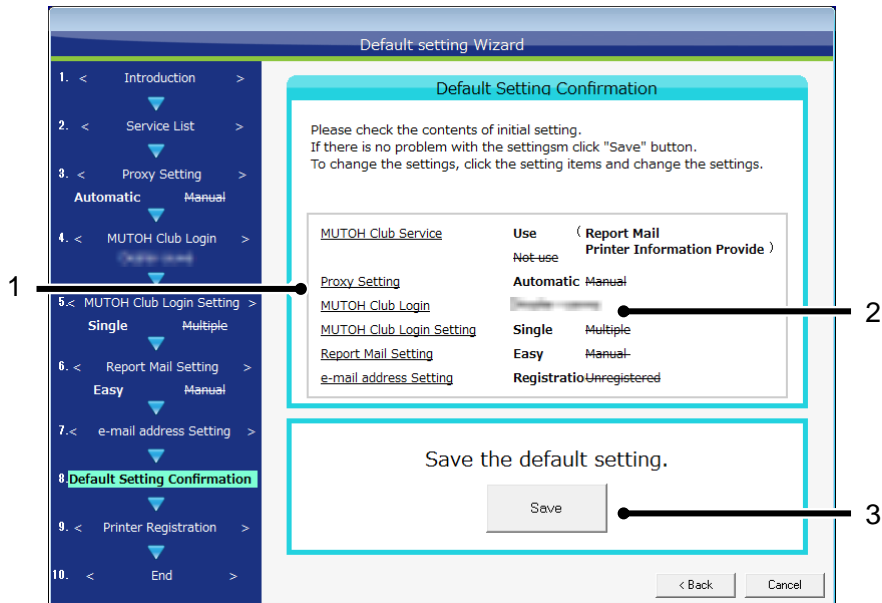

No.	Name	Description
1	Setting Items	List of initial setting items To change the setting, click the item and change the content.
2	Setting Contents	The contents of each setting will be displayed. Check the setting contents.
3	Next	Proceed to the next setting.

3.9. Printer Registration

Register the printer to be managed by MSM.

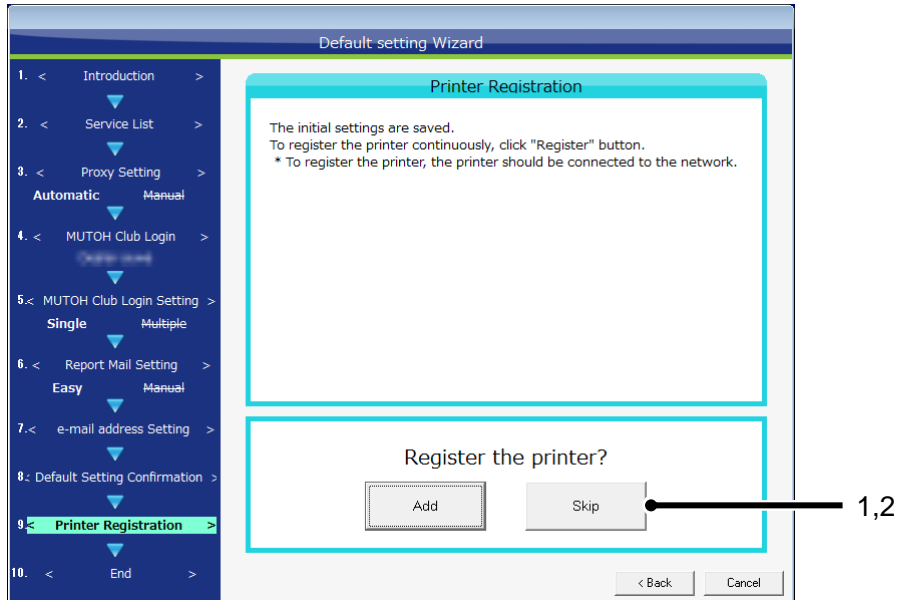

No.	Name	Description
1	Add	Register the printer on MSM.
2	Skip	The printer registration in the initial setting will be skipped.

NOTE

- To register the printer, you need to obtain the printer information through bidirectional communication with printer. Turn on the printer to set the network connection.

3.9.1 Register the printer information

Click "Add" button and select the printer registration method from the Registration Information pane.

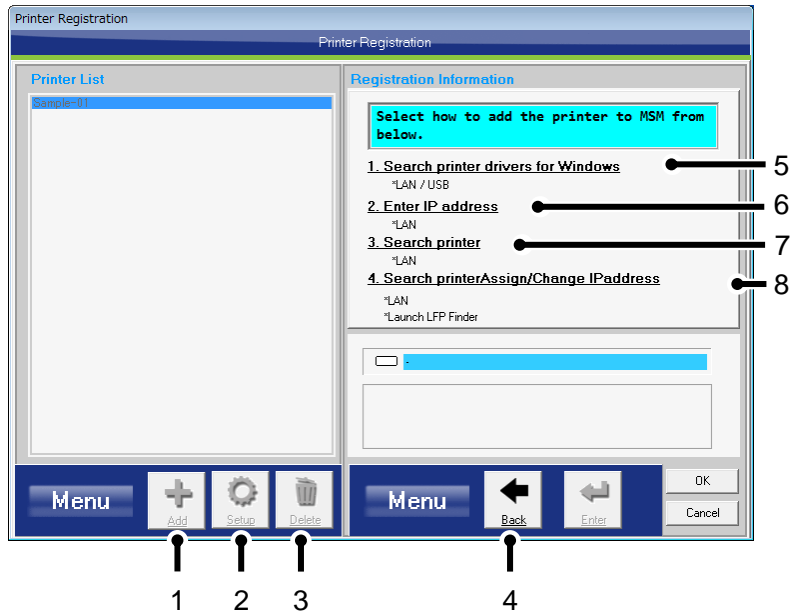

No.	Name	Description
1	Menu(Add)	Press "Add" button to register a printer.
2	Menu(Setup)	Press "Setup" button to change the registered printer information. Refer to "3.9.4" for details.
3	Menu(Delete)	Delete the registered printer.
4	Menu(Back)	Return to the printer list menu.
5	Search printer drivers for Windows	Use this option to register a printer from the Windows printer driver list being installed. Refer to "3.9.1.1Search printer drivers for Windows" for details.
6	Enter IP address	Use this option to register a printer by entering the printer IP address. Refer to "3.9.1.2Enter IP address" for details.
7	Search printer	Use this option to search a printer from the same network segment and register it to MSM. Refer to "3.9.1.3" for details. *need to be connected by LAN.
8	Search printer Assign/Change IP address	Launch LFP-Finder. Use this option to search a printer and change the printer IP address setting. *need to be connected by LAN.

3.9.1.1. Search printer drivers for Windows

Register a printer from the Windows printer driver list being installed.

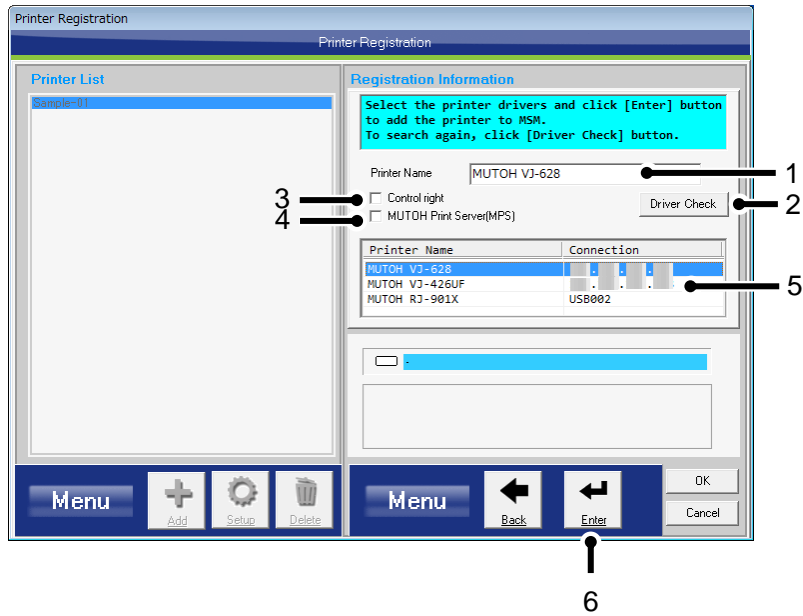

No.	Name	Description
1	Printer Name	Enter the registration name that you selected. To use several printers, please change the printer name.
2	Driver Check	Check the installed printer driver.
3	Control right	Specify the "Control Right" for the printer to be registered. Check the box to provide the MSM with a control right. Users who have control right selected can update the Smart/C. * If other MSM has control rights, the control right will not be available. * When the printer receives no communication from a user who obtains the control right for 3 minutes, the control right will be opened, and the printer gives other users a permission to obtain the control right.
4	MUTOH Print Server(MPS)	Check the box to enable MPS for the printer to be registered. MPS may not be available depending on the model.
5	Driver List	Display the list of printer driver compatible with MSM. Select the printer driver to register.
6	Menu(Enter)	Register the printer.

NOTE

- For USB connection, the printer driver installed with USB is required.

3.9.1.2. Enter IP address

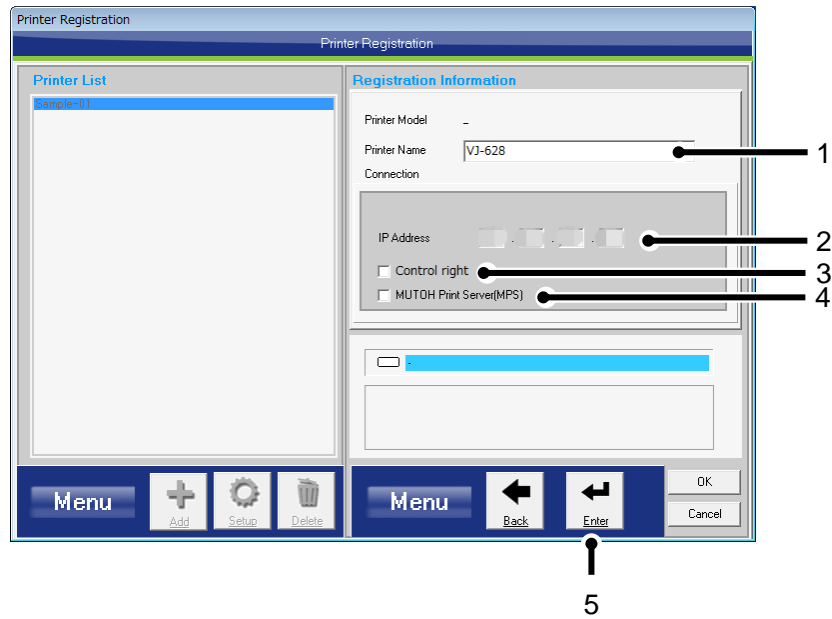

No.	Name	Description
1	Printer Name	Enter the registration name that you selected. To use several printers, please change the printer name.
2	IP Address	Enter the IP address of the printer to be registered.
3	Control right	Specify the "Control Right" for the printer to be registered. Check the box to provide the MSM with a control right. Users who have control right selected can update the Smart/C. * If other MSM has control rights, the control right will not be available. * When the printer receives no communication from a user who obtains the control right for 3 minutes, the control right will be opened, and the printer gives other users a permission to obtain the control right.
4	MUTOH Print Server(MPS)	Check the box to enable MPS for the printer to be registered. MPS may not be available depending on the model.
5	Menu(Enter)	Register the printer.

3.9.1.3. Search printer

Search a printer from the same network segment and register it to MSM.

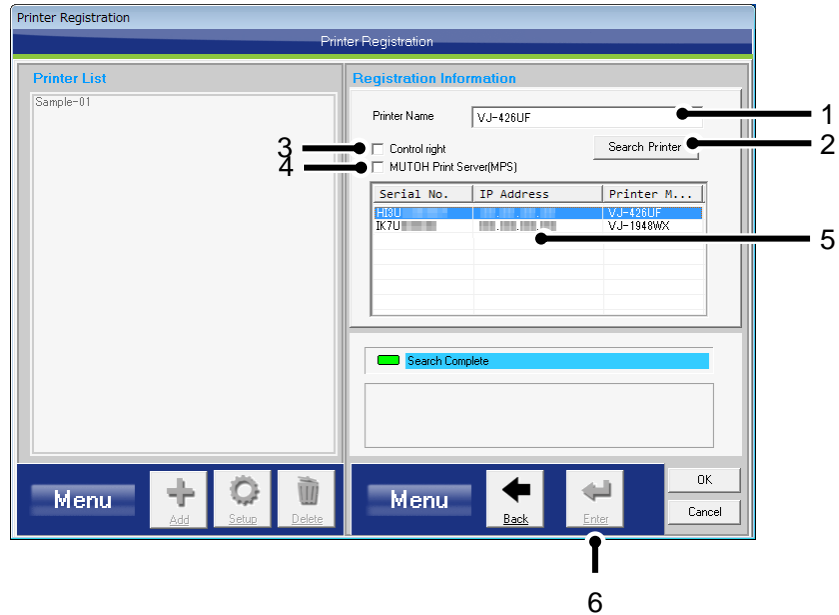

No.	Name	Description
1	Printer Name	Enter the registration name that you selected. To use several printers, please change the printer name.
2	Search Printer	Search a printer from the same network segment.
3	Control right	Check the box to provide the MSM with a control right for the printer to be registered. Users who have control right can update the Smart/C. * If other MSM has control rights, the control right will not be available. * When the printer receives no communication from a user who obtains the control right for 3 minutes, the control right will be opened, and the printer gives other users a permission to obtain the control right.
4	MUTOH Print Server(MPS)	Check the box to enable MPS for the printer to be registered. MPS may not be available depending on the model.
5	List of Printer *1	Display the printers in the same network segment.
6	Menu(Enter)	Register the printer.

NOTE

- *1 Printers connected to other network segment are not displayed in the list. To register a printer on other network segment, see 3.9.1.2.

3.9.2 Completion

When the status display shows "Success", the printer registration has completed successfully, and the printer will be added to the "Printer List".

1. For LAN connection

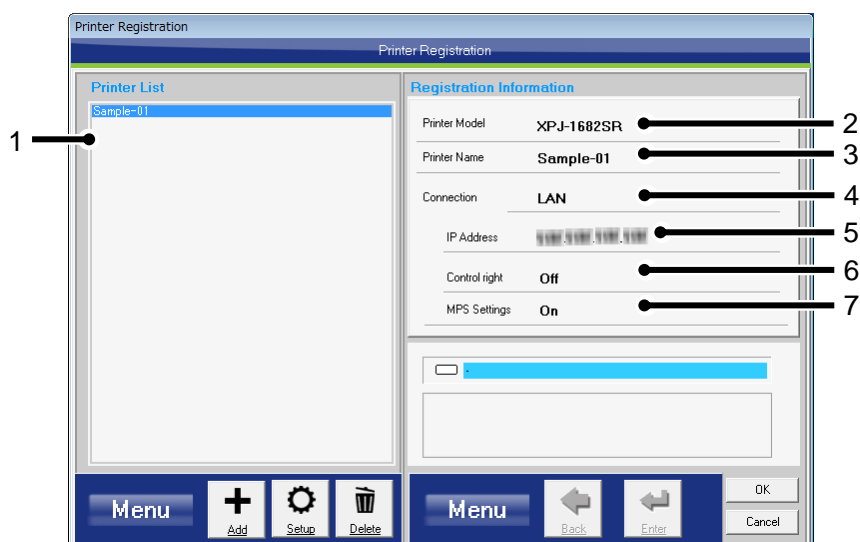

No.	Name	Description
1	Printer List	The registration name of the registered printer will be displayed.
2	Status Display	The status of printer registration will be displayed. When "Success" is displayed, the printer registration completed successfully.
3	Printer Model	The model name of the registered printer will be displayed.
4	Connection	Display the connection method with printer.
5	IP Address	Display the IP address of registered printer.
6	Control right	Display the control right for registered printer.
7	MPS Settings	Display the MPS settings for the registered printer.

2. For USB connection

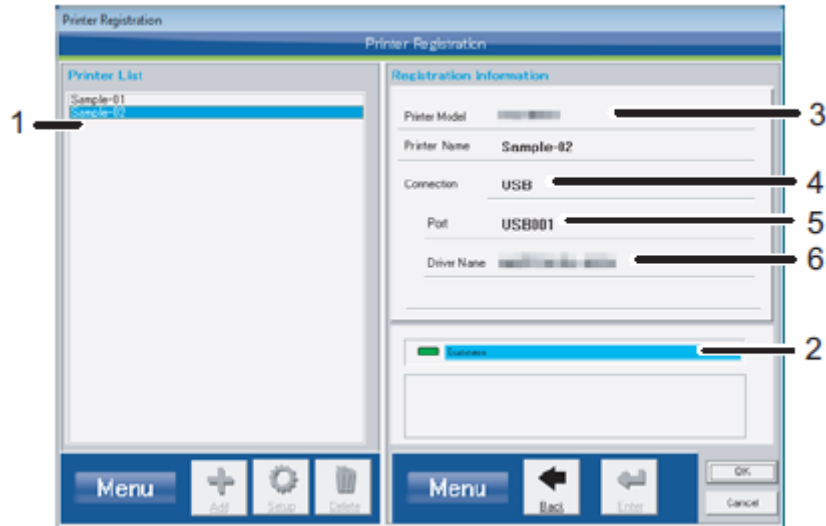

No.	Name	Description
1	Printer List	The registration name of the registered printer will be displayed.
2	Status Display	The status of printer registration will be displayed. When "Success" is displayed, the printer registration completed successfully.
3	Printer Model	The model name of the registered printer will be displayed.
4	Connection	Display the connection method with printer.
5	Port	Display the port name of registered printer.
6	Driver Name	Display the driver name of registered printer.

3.9.3 Registering several printers

If you have multiple printers, you can register all printers to the MSM. To register the multiple printers, repeat procedures "3.9.1 Register the printer information" for each unit.

The icon for connection between MSM and multiple printers:

MSM ⇔ Several Printers

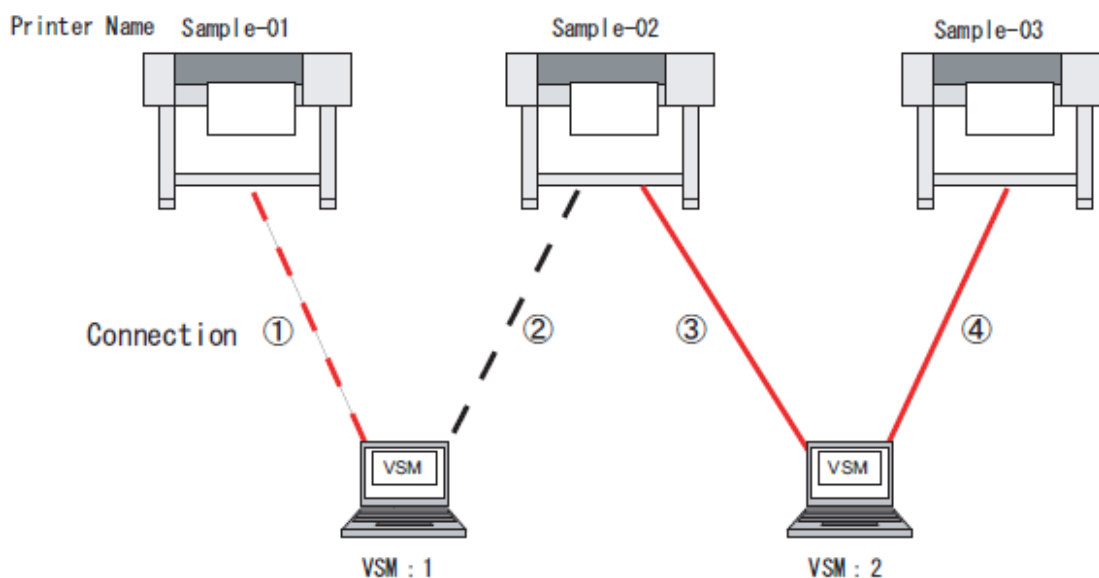

Printer Name	Connection	Control right	Smart/CUpdate
Sample-01	①	Available	Enabled
Sample-02	②	Unavailable	Disabled
	③	Available	Enabled
Sample-03	④	Available	Enabled

3.9.4 Change registered printer information

Change the printer information registered to MSM.

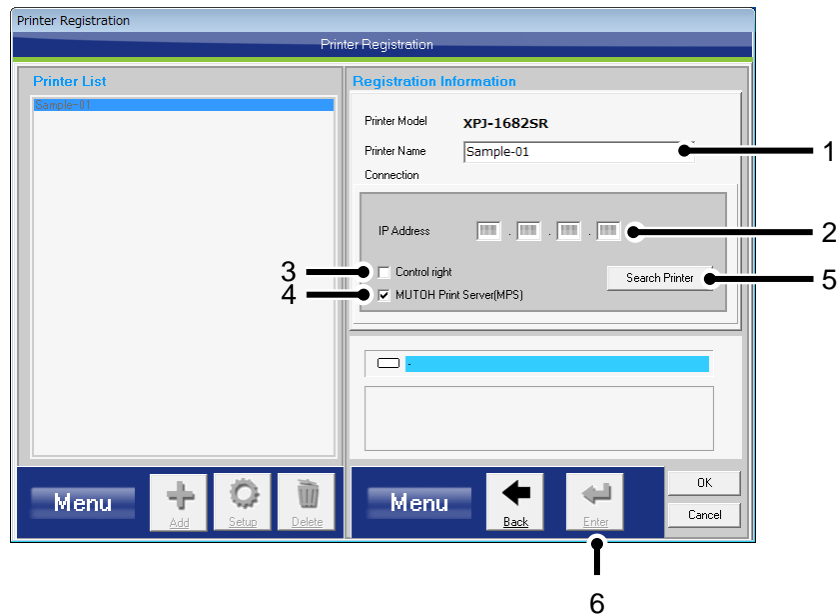

No.	Name	Description
1	Printer Name	Enter a printer registration name that you want to change the registered printer information.
2	IP Address	Enter an IP address of the printer that you want to change the registered printer information.
3	Control right	Check the box to provide the MSM with a control right for the printer to be changed. Users who have control right can update the Smart/C. * If other MSM has control rights, the control right will not be available. * When the printer receives no communication from a user who obtains the control right for 3 minutes, the control right will be opened, and the printer gives other users a permission to obtain the control right.
4	MUTOH Print Server(MPS)	Check the box to enable MPS for the printer to be changed.
5	Search Printer	Search an appropriate printer from the same network segment and check that whether the IP address of the printer has been changed. If changed, the new IP address will be displayed in the IP Address field.
6	Menu(Enter)	Apply the changes. If no changes are made, this button will be disabled.

3.10. Initial setting completed

This is the end of initial setting.

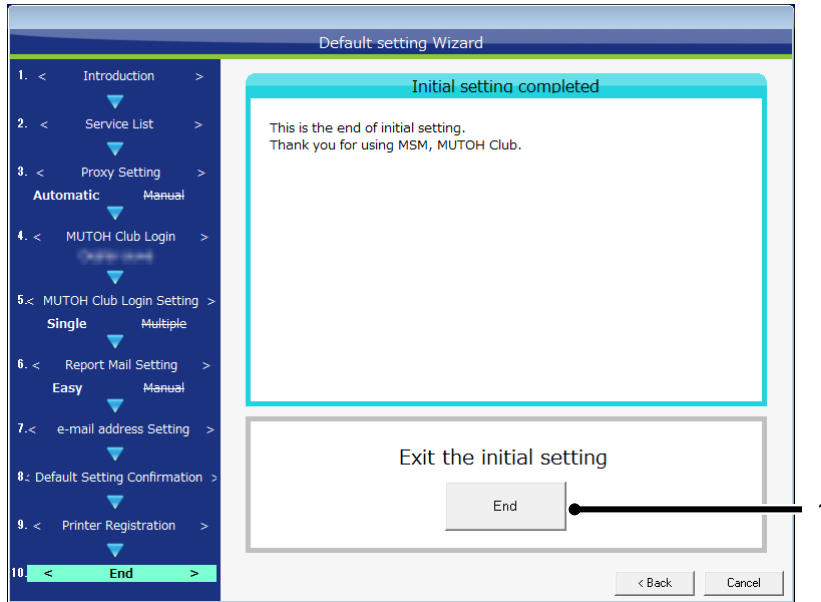

No.	Name	Description
1	End	Exit the initial setting.

4. Start/Exit

4.1. Start

When the installation of MSM is complete, the program will be registered and a shortcut will be created on the desktop.

Start MSM using either of the following two methods.

- Click [Start]-[All Programs]-[Mutoh]-[Mutoh Status Monitor]
- Double click [Mutoh Status Monitor] icon on desktop.

NOTE

- If MSM is already running, please note that multiple applications of MSM cannot be opened.

4.2. Task Tray Icon

MSM icon will be displayed on the task bar when the MSM starts.

Click the right mouse button to display the menu.

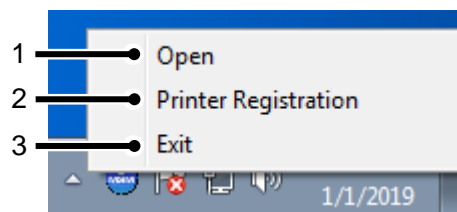

No.	Name	Description
1	Open	The MSM main screen will appear.
2	Printer Registration	The printer registration screen will appear.
3	Exit	Exit the MSM.

4.3. Title bar

Click the minimize button on the title bar to minimize the MSM.

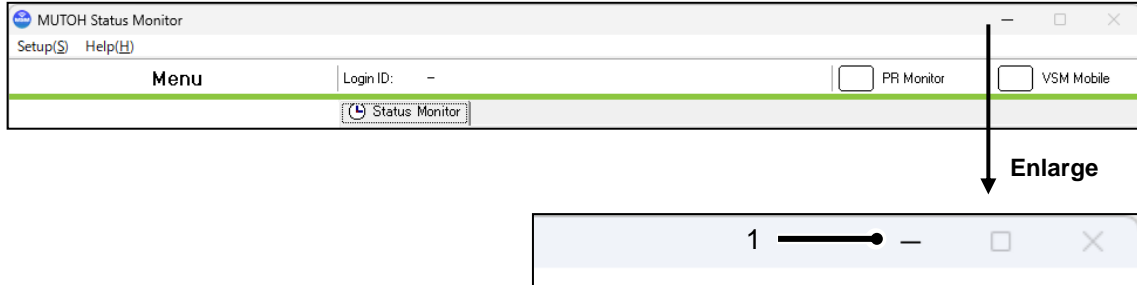

No.	Name	Description
1	Minimize	Minimize MSM, leaving the icon on the taskbar.

5. MSM Setting

5.1. Setting

Perform various settings for MSM.

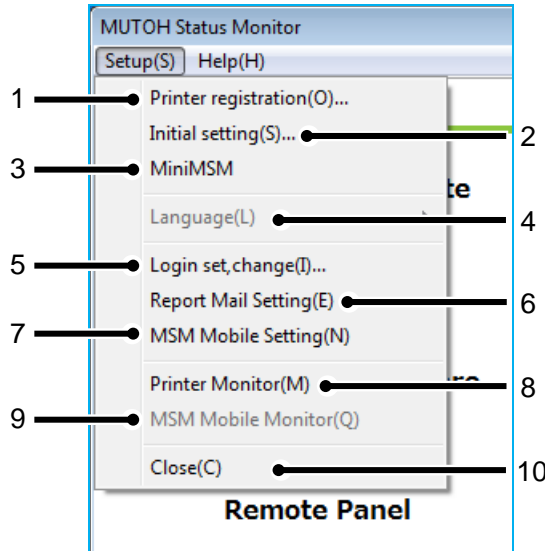

No.	Name	Description
1	Printer Registration	Register the printer to be managed by MSM. Refer to "3.9 Printer Registration" for the details.
2	Initial Setting	Perform the initial setting for the MSM. Refer to "3.Initial Setting" for the details.
3	MiniMSM	The MSM window can be downsized by enabling MiniMSM. With this feature, some functions are limited.
4	Language *1	Configure the language displayed in the MSM. Choose a language from the list. When enabling the language setting, a message to terminate the program will be displayed. If you are done selecting the language, it is OK to terminate the program, click "OK" button. <div data-bbox="842 1485 1238 1637" data-label="Image"> </div> <p>* Changes will take effect when the program is restarted.</p>
5	Login Set, Change	Log in to MSM. Refer to "3.4 MUTOH Club Login" for details.
6	E-mail Notification Setting	Set up the mail notification system. Refer to "9.Report Mail" for details.

No.	Name	Description
7	VSM Mobile Setting	Set up the VSM Mobile. Refer to "11.1.2 MSM Setting" for details.
8	Printer Monitor	The registered printer will be automatically monitored. When operating with "Smart/C Automatic Update", the Smart/C of each printer can be updated automatically.
9	VSM Mobile Monitor	Enable the communication from VSM Mobile.
10	Close	Close the MSM main window.

NOTE

- *1 Available under Japanese OS. For other OS, only English is available.

5.2. Help

Check information about MSM.

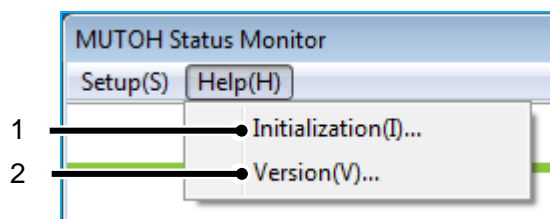

No.	Name	Description
1	Initialization	Initialize the MSM settings. * Perform the initialization when the operation of MSM is unstable.
2	Version	The MSM version information will be displayed.

5.2.1 Initialization

Initialize the MSM settings.

Perform the initialization when the operation of MSM is unstable.

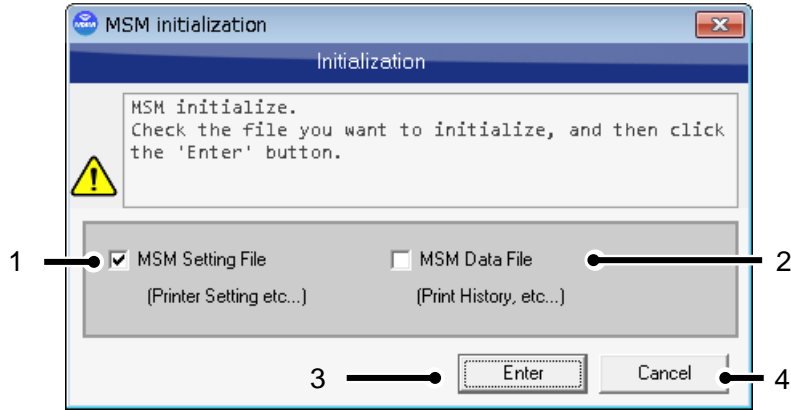

No.	Name	Description
1	MSM Setting File *1	Delete the MSM settings files listed below: - MSM Setting File - Report Mail - VSM Mobile - MPS - Temporary File
2	MSM Data File *2	Delete the SM data files listed below: - Print History - Color Verify
3	Enter	Initialize the file selected.
4	Cancel	Exit the initialization dialog without initialization.

NOTE

- *1 After the initialization is complete, MSM will exit. To configure the initial settings, restart MSM.
- *2 The history data listed above will be deleted after the initialization. The data cannot be retrieved once deleted.

5.2.2 Version

1. Click [Help]-[Version].
2. To check for the MSM updates, click [Check for updates].
3. Exit the version information menu.

Click "Exit" button to close the dialogue box.

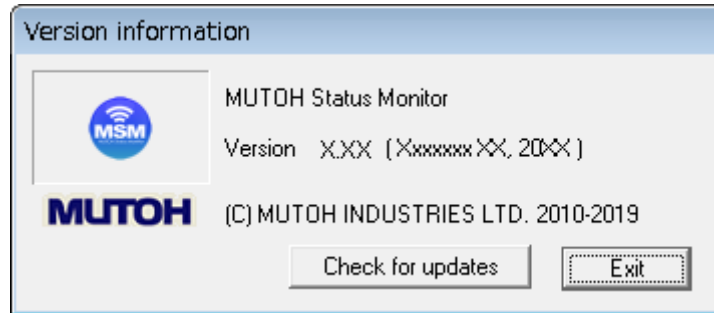

5.2.2.1. Check and download the latest MSM version

To use the latest MSM, check and download the latest available MSM version from MUTOH Club.

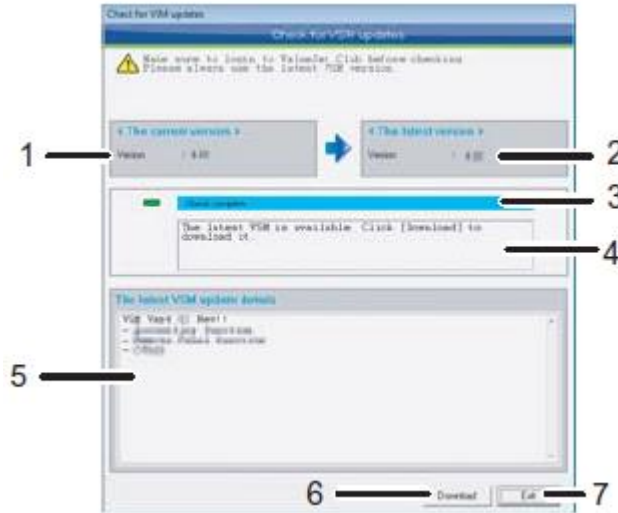

No.	Name	Description
1	The current version	Display the currently running MSM version.
2	The latest version	Display the latest available MSM version after checking from MUTOH Club.
3	Status	Display the update check status and download status.
4	Detail	Display the check status details, download procedure and error message.
5	MSM update details	Display the update details for the latest available MSM version after checking from MUTOH Club.
6	Download	Allow you to download the latest available MSM after checking from MUTOH Club.
7	Exit	Exit the menu.

NOTE

- Make sure to login to MUTOH Club before checking for available updates.
- The downloaded file is compressed in ZIP format. Unzip it and install MSM.

6. Menu

This chapter describes the MSM menu.

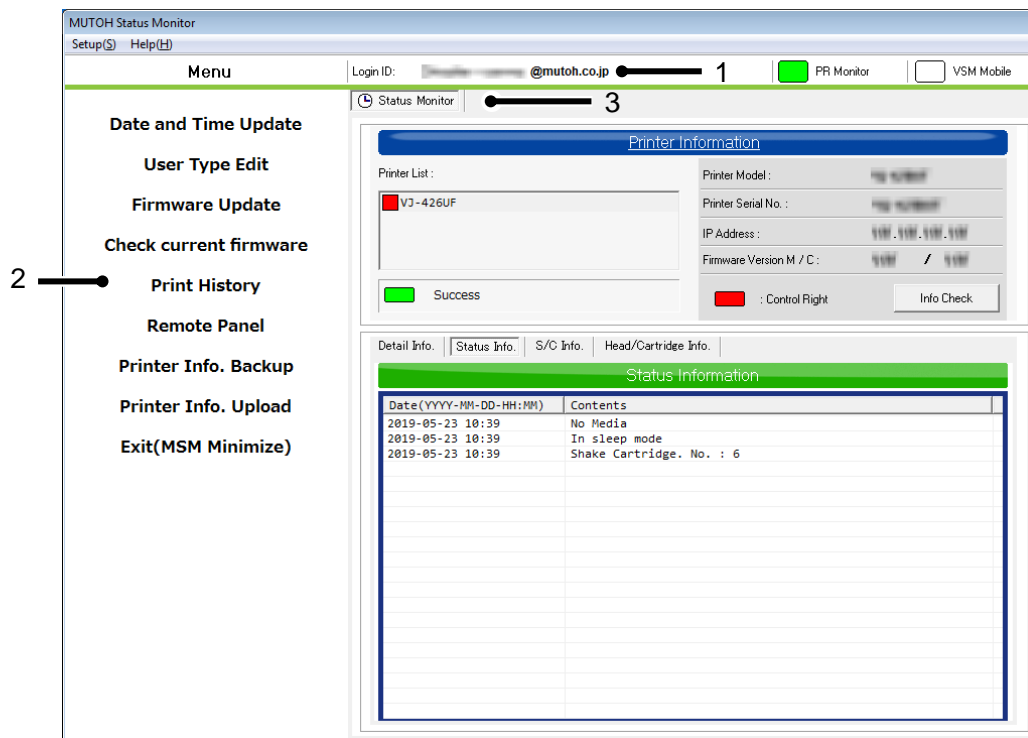

No.	Name	Description
1	User Setting Information	Information regarding user settings will be displayed. Refer to "6.1 User Setting Information" for details.
2	Menu	Functions available for the MSM can be selected. Refer to "6.2 Menu" for the details.
3	Status Monitor	Monitor the status of current printer. Refer to "7.Status monitor" for the details.

6.1. User Setting Information

Information regarding user settings will be displayed.

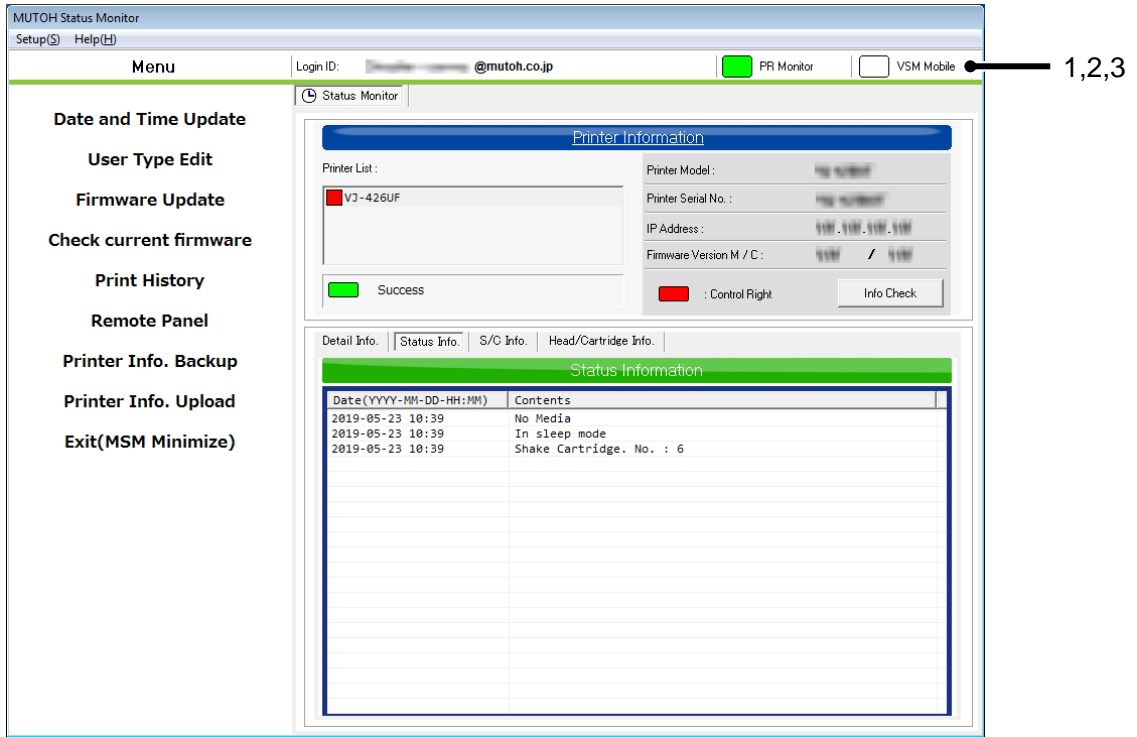

No.	Name	Description
1	Login ID	The login ID for Mutoh Club will be displayed. Only the update of Smart/C are available using the MSCF without login. The Smart/C cannot be updated with the Mutoh Club.
2	PR Monitor	Displays whether the printer is automatically monitored or not. <input checked="" type="checkbox"/> : Monitoring the Printer <input type="checkbox"/> : Not Monitoring the Printer
3	VSM Mobile	Displays whether the printer is automatically monitored or not. <input checked="" type="checkbox"/> : Monitoring the VSM Mobile <input type="checkbox"/> : Not Monitoring the VSM Mobile

6.2. Menu

Available functions with MSM.

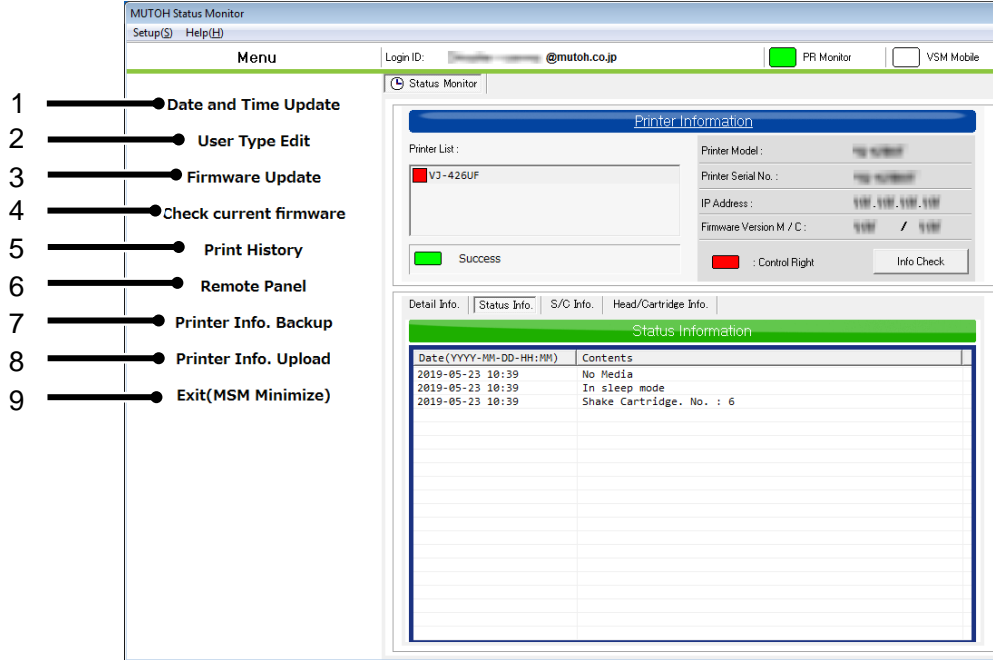

NOTE

- The available functions vary according to printer model.

No.	Name	Description
1	Date and Time Update	Set the date and time setting of printer to be matched with PC setting. Refer to "6.2.1 Date and Time Update" for the details.
2	Media Type Edit	The name of user media can be edited for the printer. Refer to "6.2.2 Media Type Edit" for the details.
3	Firmware Update	Update the printer firmware. * The firmware data is required. Refer to "6.2.3 Firmware Update" for the details.
4	Check current firmware	Check current firmware for the MB-Web via the Internet. Refer to "6.2.4 Check the Latest Firmware" for the details.
-	ColorVerify	Execute the Color Verify. Refer to "10 ColorVerify" for the details.
5	Print History	This function allows MSM to get print history information from printer and monitor the history. Refer to "12 Print History" for the details.
6	Remote Panel	This function allows you to check the current panel setting in your printer and perform test pattern printing. Refer to "13 Remote Panel" for the details.

No.	Name	Description
7	Printer Information Backup	Save the printer information on a disk. Refer to "6.2.5 Printer Information Backup" for the details.
8	Printer Information Upload	With an internet connection to the MUTOH Club server, upload the printer information to the server. Refer to "6.2.6 Printer Information Upload" for the details.
9	Exit(MSM Minimize)	Minimize the MSM. Refer to the "6.2.7 Exit (MSM Minimize)" for the details.

6.2.1 Date and Time Update

Set the date and time setting of printer to be matched with PC setting.

NOTE

- Check that the date and time setting of PC is correct.
 - This function will not be available when the printer has limitation.
-

6.2.2 Media Type Edit

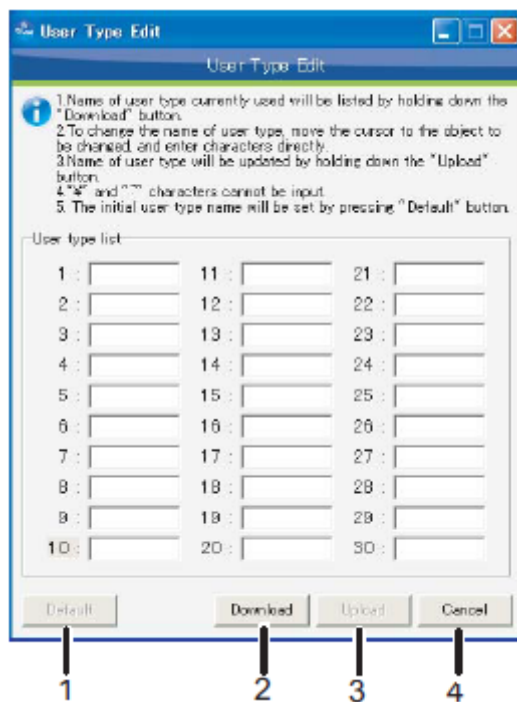

No.	Name	Description
1	Default	Initialize the name of user media and the list of user type name.
2	Download	Acquire the current user media list that is registered in the printer.
3	Upload	Send the edited user media list to the printer to update the user media list.
4	Cancel	Cancel the editing of user media.

NOTE

- The function name varies by the model.

6.2.3 Firmware Update

Update the printer firmware.

Please check the notes and follow the procedure below to update the firmware.

- Procedure >
- 6.2.3.1 Select the Firmware File
 - 6.2.3.2 Check the Firmware File
 - 6.2.3.3 Printer Update Preparation
 - 6.2.3.4 Send the Firmware File
 - 6.2.3.5 Update the Firmware
 - 6.2.3.6 Completion of Firmware Update

NOTE

- Do not turn off the printer and unplug the cable while updating the firmware. In that case, the firmware update will not complete normally, and the printer may not be started.
 - The firmware file is needed to update the firmware.
 - The older version than the firmware installed in the printer cannot be updated.
 - The update is available when the message "Ready to Print" is displayed on the printer panel. The update is not available while printing and operating.
 - Check that the printer and blower heater are in standby status, in order to update the firmware for blower heater.
 1. The main power supply of blower heater is set to "ON".
 2. The "Link" switch of blower heater is set to "Manual".
 3. The "RUN/STOP" switch of blower heater is set to "STOP".
-

6.2.3.1. Select the Firmware File

Select the firmware file to update.

There are two types of firmware file.

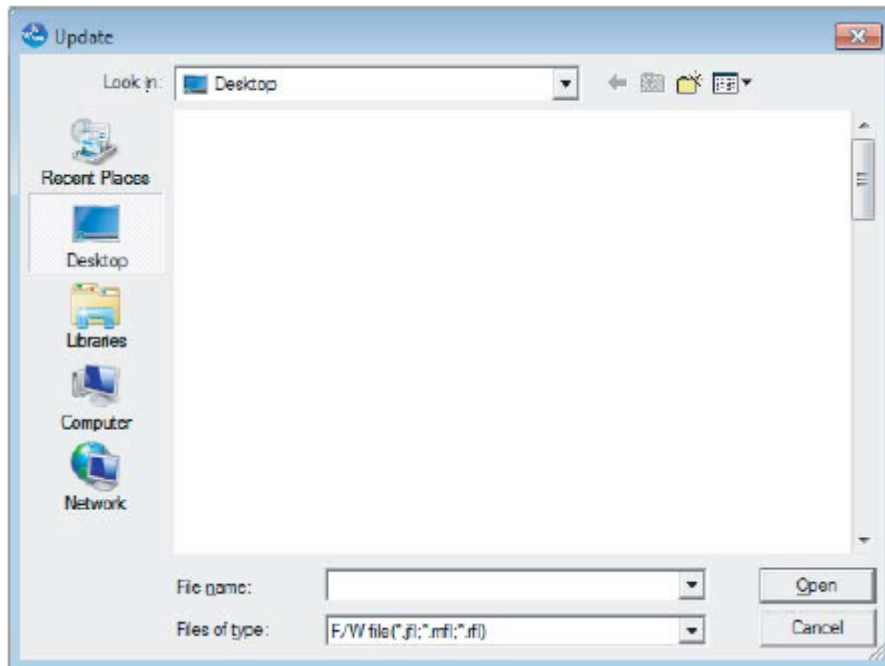

Extension	Contents
jfl	Firmware Data for Main
mfl	Firmware Data for Controller
rfl	Firmware Data for Blower Heater

6.2.3.2. Check the Firmware File

Check the contents of selected firmware file.

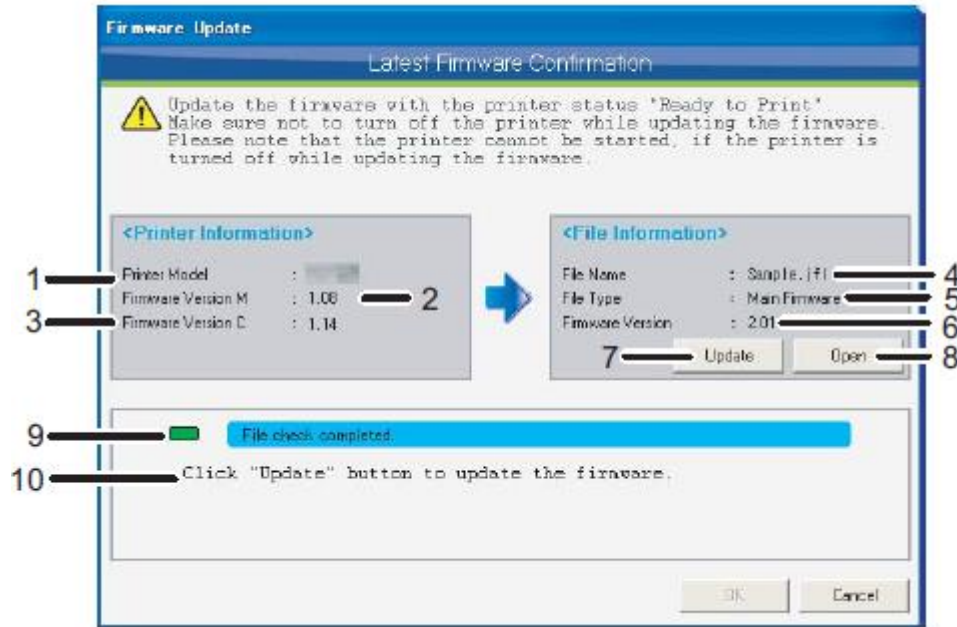

No.	Name	Description
1	Printer Model	Display the model name of the printer.
2	Firmware Version M	Display the main firmware version of the printer.
3	Firmware Version C	Display the controller firmware version of the printer.
4	File Name	Display the name of selected firmware file.
5	File Type	Display the type of selected firmware file.
6	Firmware Version	Display the version of selected firmware file.
7	Update	If there is no problem with the selected firmware file, buttons will be valid, and the firmware can be updated.
8	Open	The firmware file selection screen will be displayed. Refer to "6.2.3.1 Select the Firmware File" for the details.
9	Status	Display the status of firmware update.
10	Detailed Information	Display the detail information of firmware update.

6.2.3.3. Printer Update Preparation

Click "Update" button to shift to the update mode. Please wait until the printer shifts to the update mode.

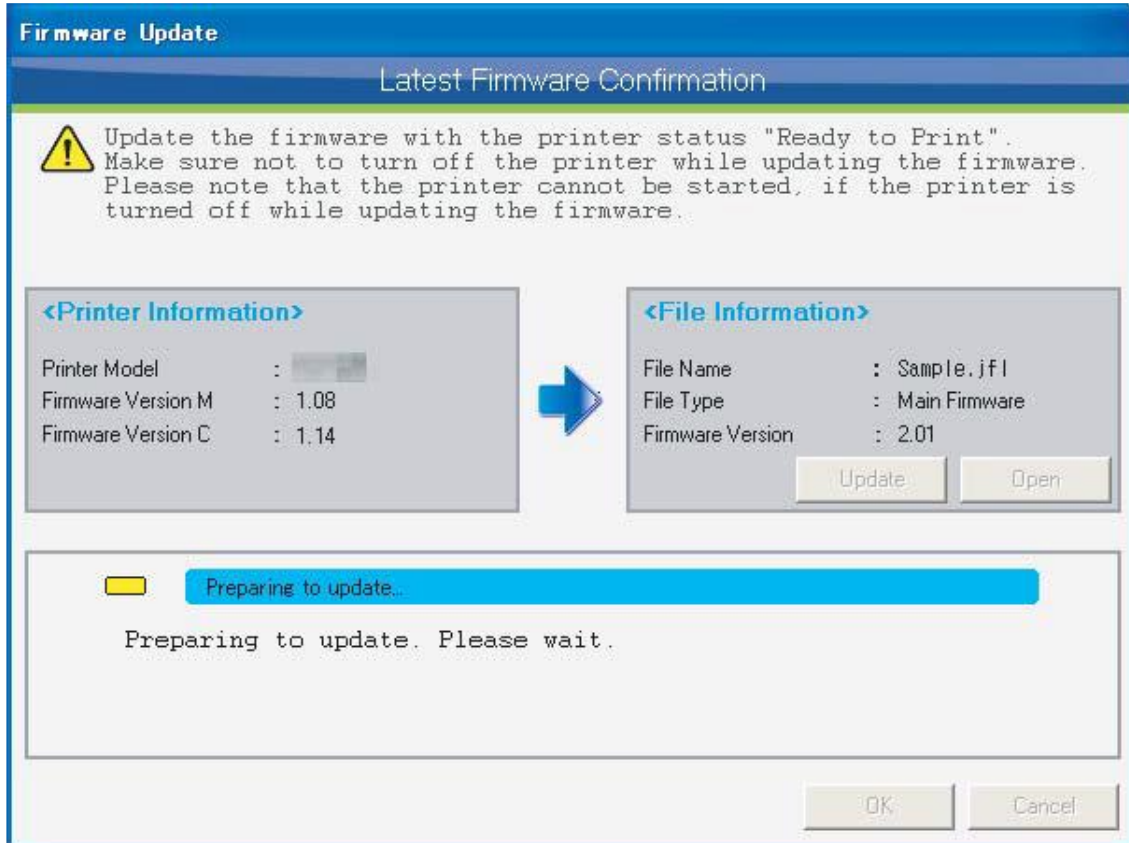

NOTE

- It may take a few minutes to shift to the update mode.
- If the printer does not shift to the update mode, click "Cancel" button and restart the printer.

6.2.3.4. Send the Firmware File

When the printer is shifted to the update mode, the selected firmware file will be sent to the printer automatically. Please wait.

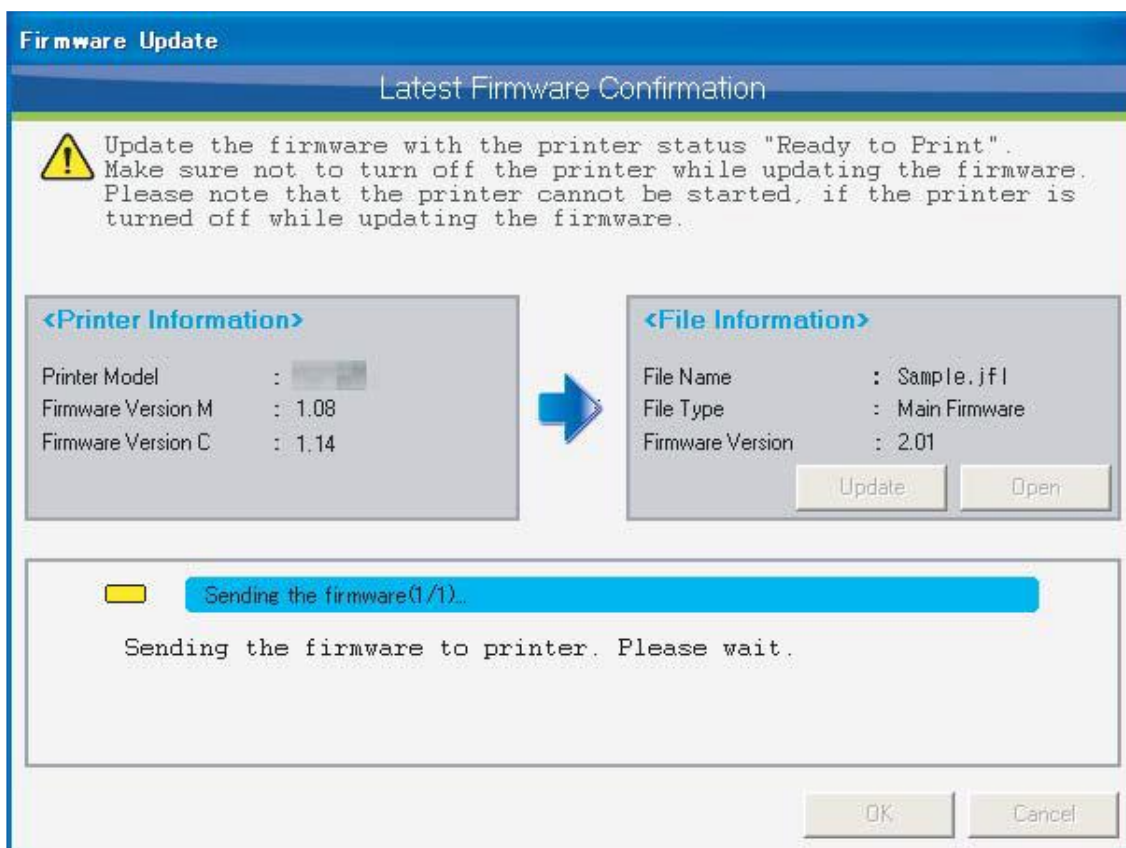

NOTE

- It may take a few minutes to send the firmware file.
- Once the firmware file is sent to the printer, the update cannot be canceled.
- Do not turn off the printer and unplug the cable while sending the firmware file. In that case, the firmware update will not complete normally, and the printer may not be started.

6.2.3.5. Update the Firmware

When the printer received the firmware file, the printer executes firmware update. Please wait.

During firmware update, the MSM monitors the printer until the firmware update is completed. If the firmware update is not completed, click "Cancel" button to stop monitoring.

* The firmware update cannot be canceled even the monitoring is stopped by pressing "Cancel" button. If you stopped the monitoring, please check the update status on the printer panel.

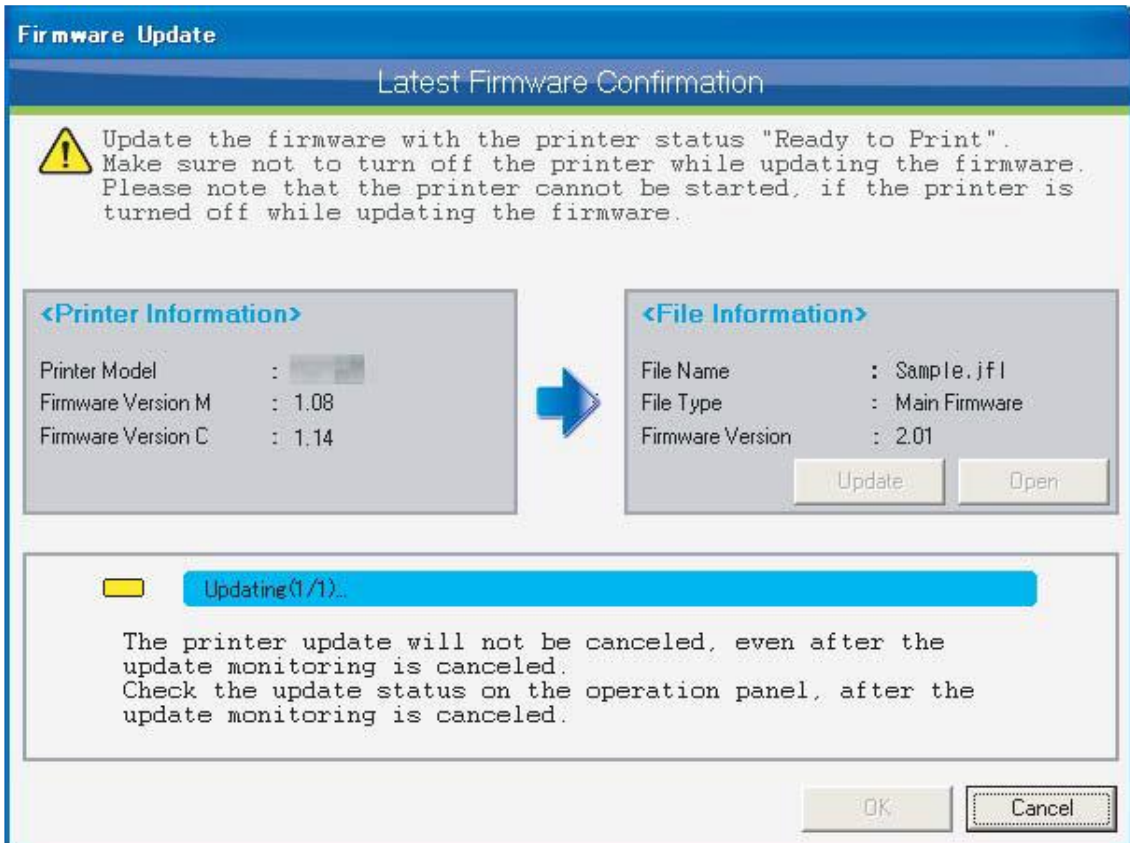

NOTE

- It may take a few minutes to update the firmware.
- Do not turn off the printer while updating. The printer may not be started normally.

6.2.3.6. Completion of Firmware Update

When the firmware update is completed, restart the printer.

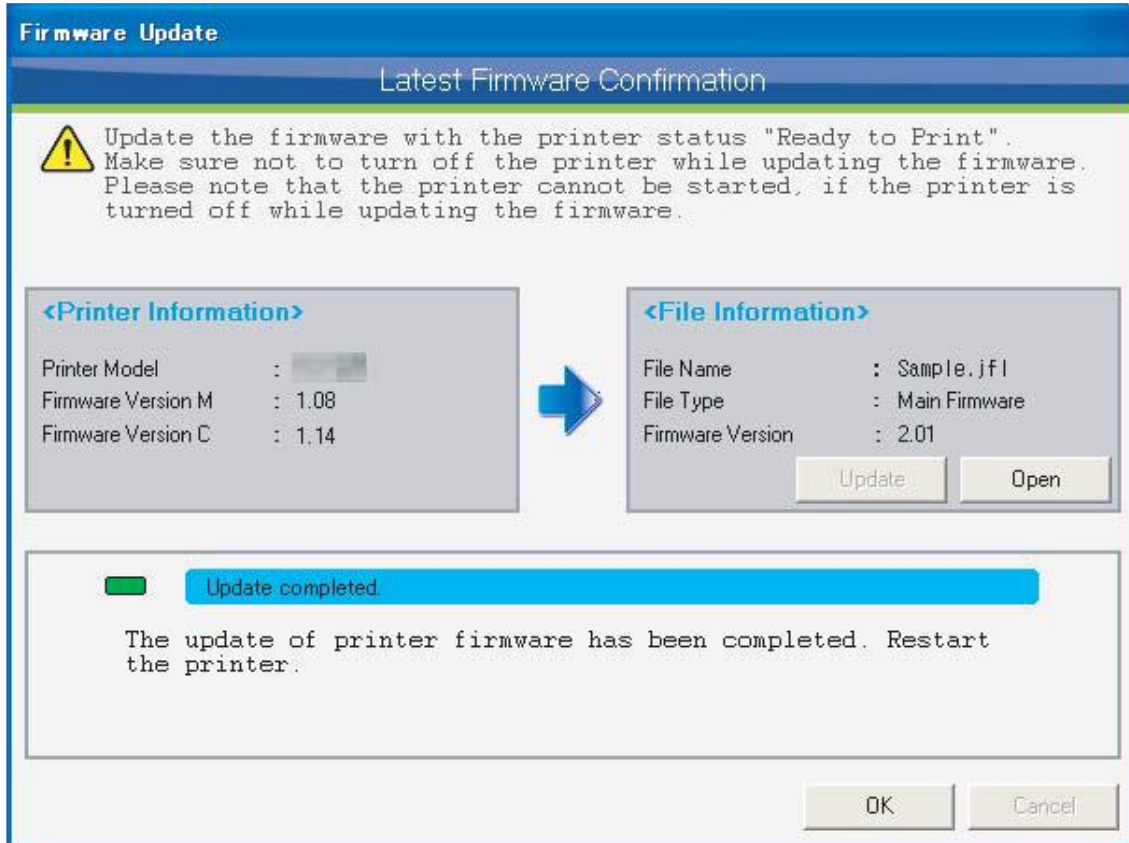

NOTE

- Even the firmware update is completed, the printer is still in the update mode. Therefore, make sure to restart the printer.

6.2.4 Check the Latest Firmware

Check with MUTOH Club if the firmware version in the printer is latest. When a newer firmware version exists, download the latest firmware file and update the firmware.

Please check the notes and follow the procedure below to check the latest firmware.

- Procedure >
- 6.2.4.1 Check the Latest Firmware Version
 - 6.2.4.2 Check the Firmware Change History
 - 6.2.4.3 Check the Special Firmware
 - 6.2.4.4 Firmware File Download
 - 6.2.4.5 Check the Firmware Update
 - 6.2.4.6 Printer Update Preparation
 - 6.2.4.7 Send the Firmware File
 - 6.2.4.8 Update the Firmware
 - 6.2.4.9 Completion of Firmware Update

NOTE

- When following conditions are met, you can check the latest firmware.
 - Have Internet connection
 - Already log in to MUTOH Club
 - Do not turn off the printer and unplug the cable while updating the firmware. In that case, the firmware update will not complete normally, and the printer may not be started.
 - The older version than the firmware installed in the printer cannot be updated.
 - The update is available when the message "Ready to Print" is displayed on the printer panel. The update is not available while printing and operating.
 - Check that the printer and blower heater are in standby status, in order to update the firmware for blower heater.
 1. The main power supply of blower heater is set to "ON".
 2. The "Link" switch of blower heater is set to "Manual".
 3. The "RUN/STOP" switch of blower heater is set to "STOP".
-

6.2.4.1. Check the Latest Firmware Version

Check the latest firmware version with MUTOH Club.

The following procedure will be executed automatically to check the latest firmware version.

1. Acquire the printer information
2. Check the latest firmware version with MUTOH Club

When the latest firmware does not exist, the window below will be displayed.

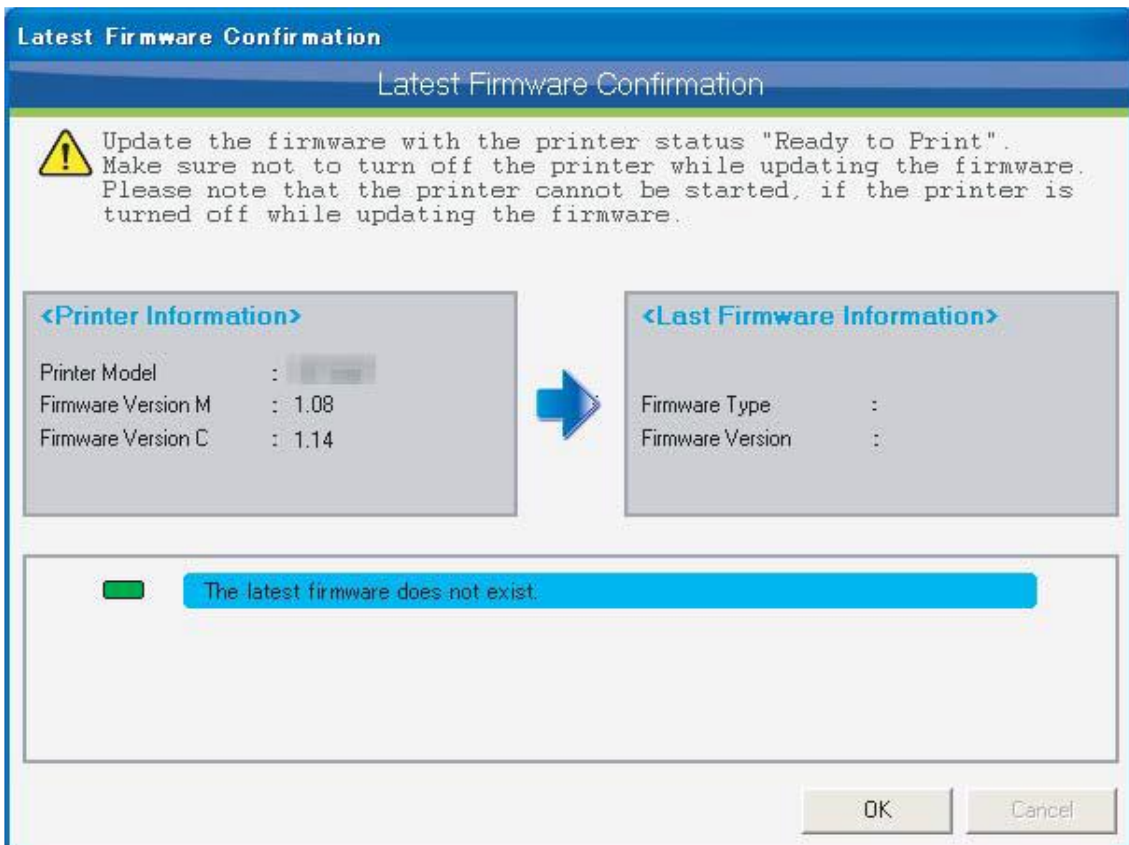

When the latest firmware version exists, the change history window will be displayed.

Refer to the next page for the details.

6.2.4.2. Check the Firmware Change History

When the latest firmware version exists, the change history window will be displayed.

Check the contents of change history, and click "Update" button to update the firmware. Refer to "6.2.4.4 Firmware File Download" for the details.

Click "OK" button to exit without updating the firmware.

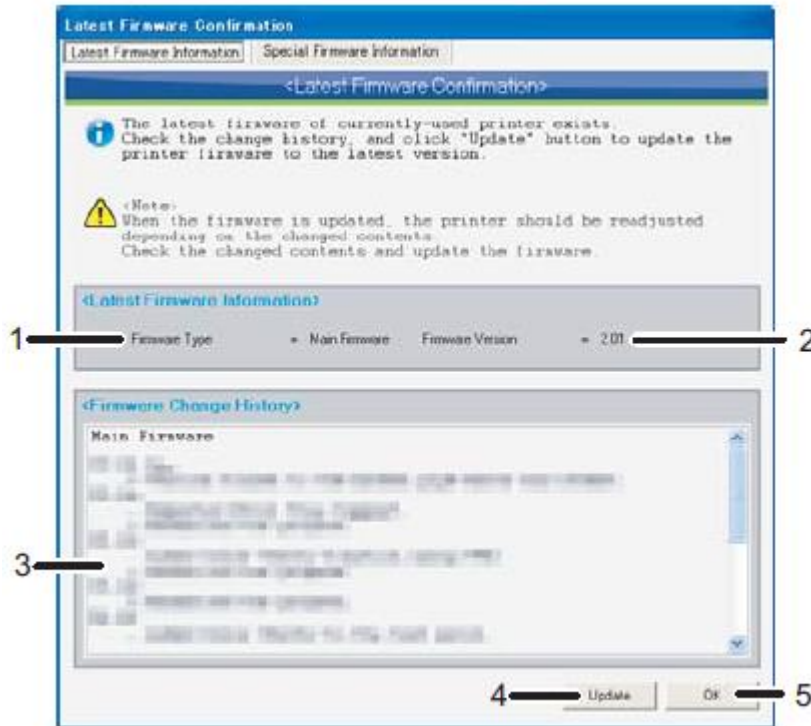

No.	Name	Description
1	Firmware Type	Display the firmware type.
2	Firmware Version	Display the firmware version.
3	Firmware Change History	Display the firmware change history.
4	Update	Click "Update" button to update to the firmware.
5	OK	Click "OK" button to check and exit without updating the firmware.

NOTE

- Readjustment will be required depending on the changed content. Therefore, check the changed contents and update the firmware.

6.2.4.3. Check the Special Firmware

When a special firmware exists, a special firmware information window will be displayed.

Check the change history, and contact to the dealer to update the firmware.

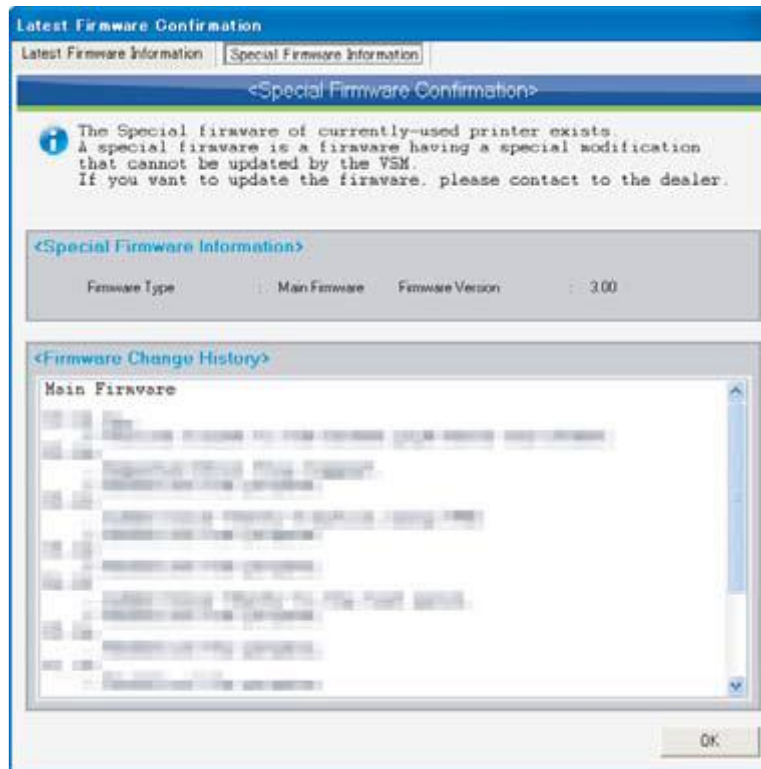

NOTE

- A special firmware is a firmware having a special modification that cannot be updated by the MSM. If you want to update the firmware, please contact to the dealer.

6.2.4.4. Firmware File Download

Download the latest firmware file from MUTOH Club.

Specify the destination to save the file, and start download.

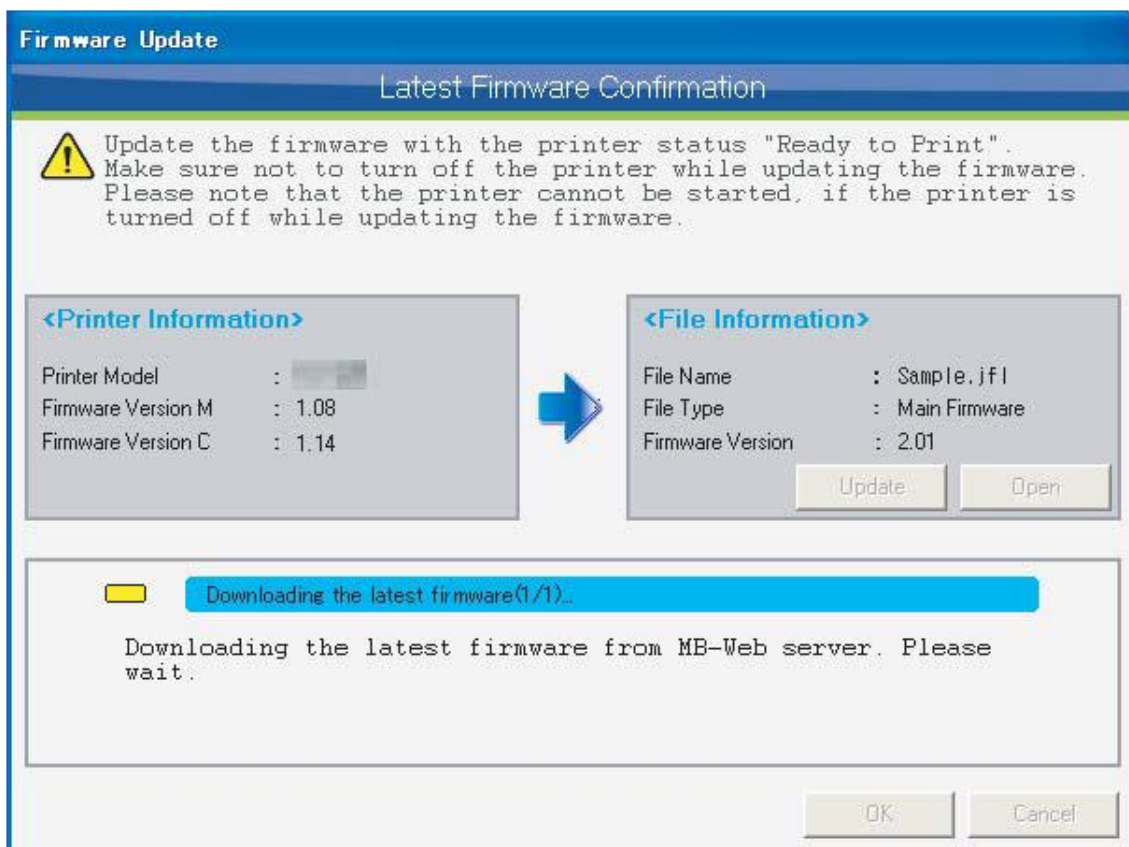
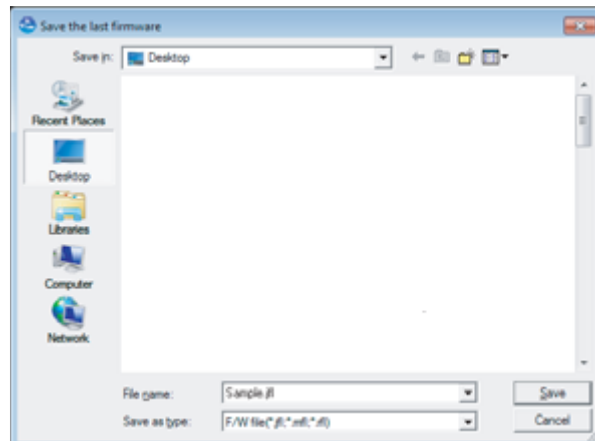

NOTE

- The downloaded firmware file can be updated separately using "6.2.3 Firmware Update" function.

6.2.4.5. Check the Firmware Update

After the firmware download is completed, the confirmation window below will be displayed.

Click "OK" button to update the firmware.

Click "Cancel" button to exit without updating the firmware.

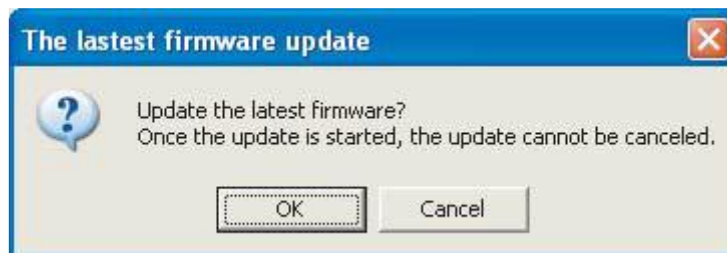

NOTE

- Once you proceed to the next step, the firmware update cannot be stopped.
 - Do not turn off the printer and unplug the cable while updating the firmware. In that case, the firmware update will not complete normally, and the printer may not be started.
 - The update is available when the message "Ready to Print" is displayed on the printer panel. The update is not available while printing and operating.
-

6.2.4.6. Printer Update Preparation

Click "Update" button to shift to the update mode. Please wait until the printer shifts to the update mode.

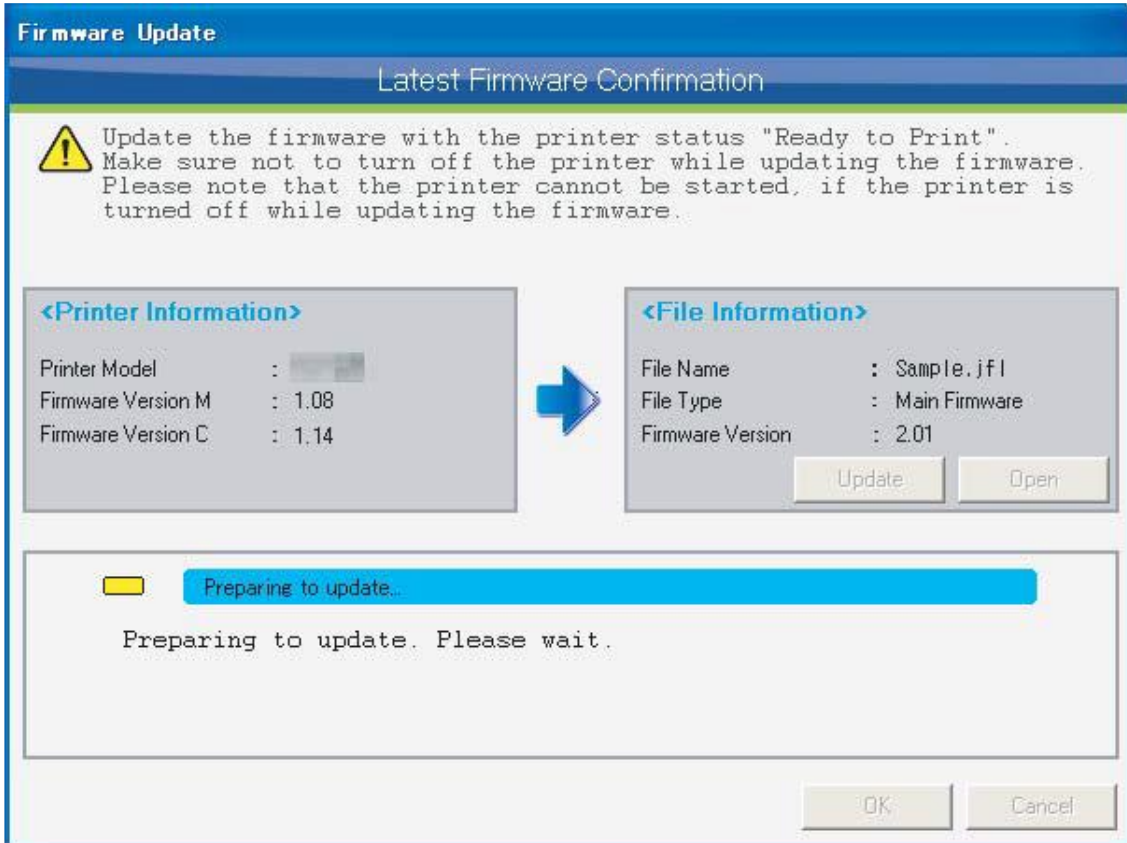

NOTE

- It may take a few minutes to shift to the update mode.
- If the printer does not shift to the update mode, click "Cancel" button and restart the printer.

6.2.4.7. Send the Firmware File

When the printer is shifted to the update mode, the downloaded firmware file will be sent to the printer automatically. Please wait.

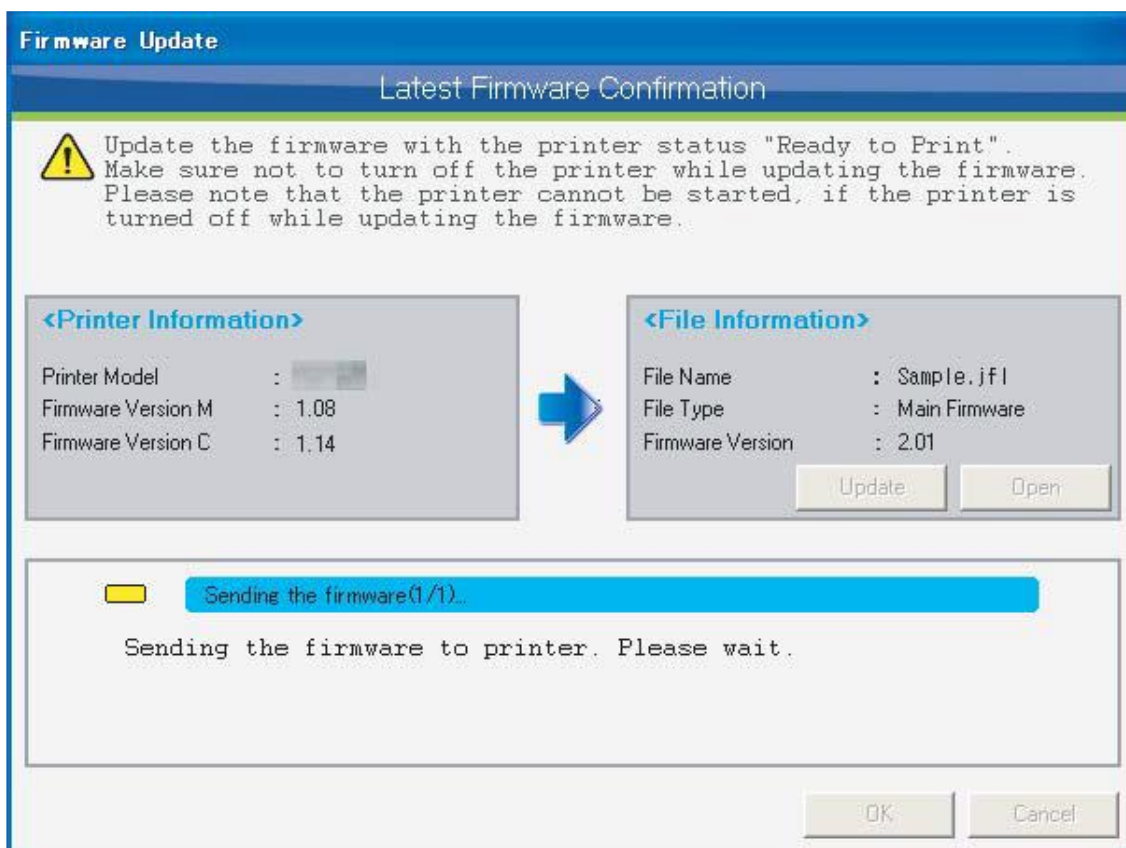

NOTE

- It may take a few minutes to send the firmware file.
- Once the firmware file is sent to the printer, the update cannot be canceled.
- Do not turn off the printer and unplug the cable while sending the firmware file. In that case, the firmware update will not complete normally, and the printer may not be started.

6.2.4.8. Update the Firmware

When the printer received the firmware file, the printer executes firmware update. Please wait.

During firmware update, the MSM monitors the printer until the firmware update is completed. If the firmware update is not completed, click "Cancel" button to stop monitoring.

* The firmware update cannot be canceled even the monitoring is stopped by pressing "Cancel" button. If you stopped the monitoring, please check the update status on the printer panel.

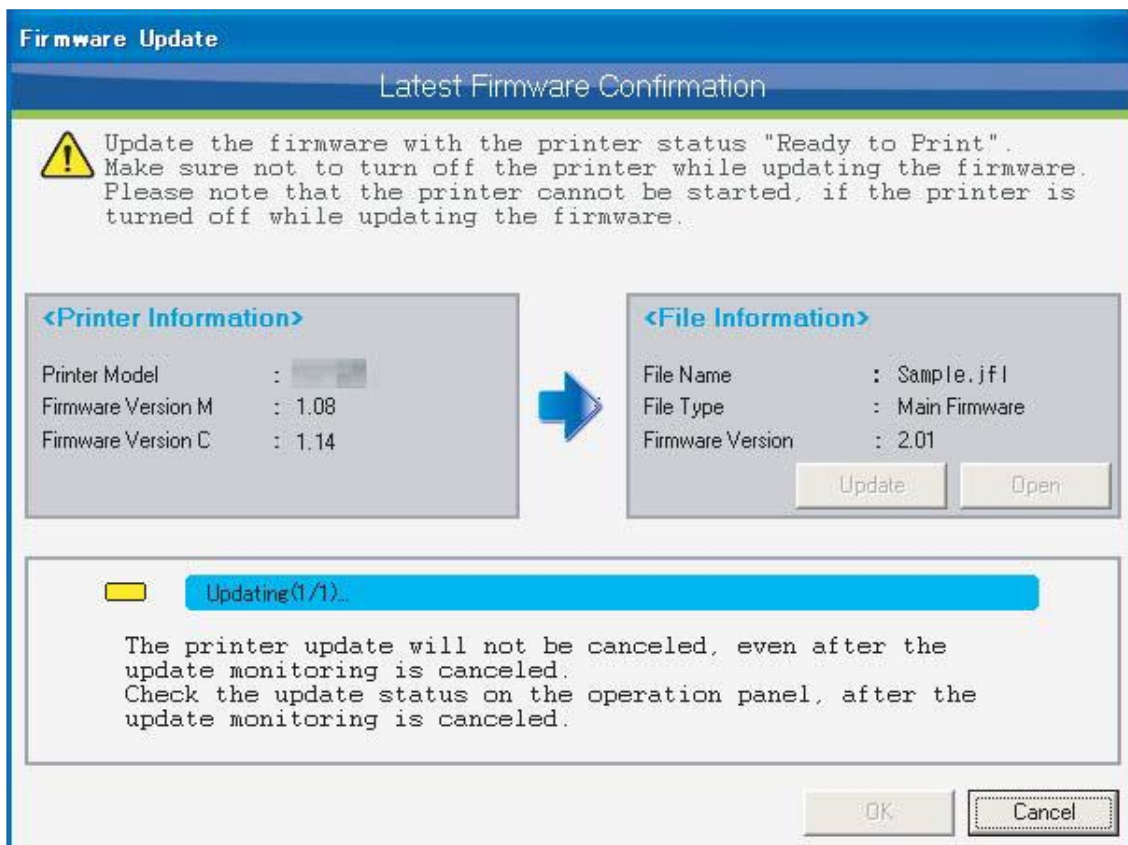

NOTE

- It may take a few minutes to update the firmware.
- Do not turn off the printer while updating. The printer may not be started normally.

6.2.4.9. Completion of Firmware Update

When the firmware update is completed, restart the printer.

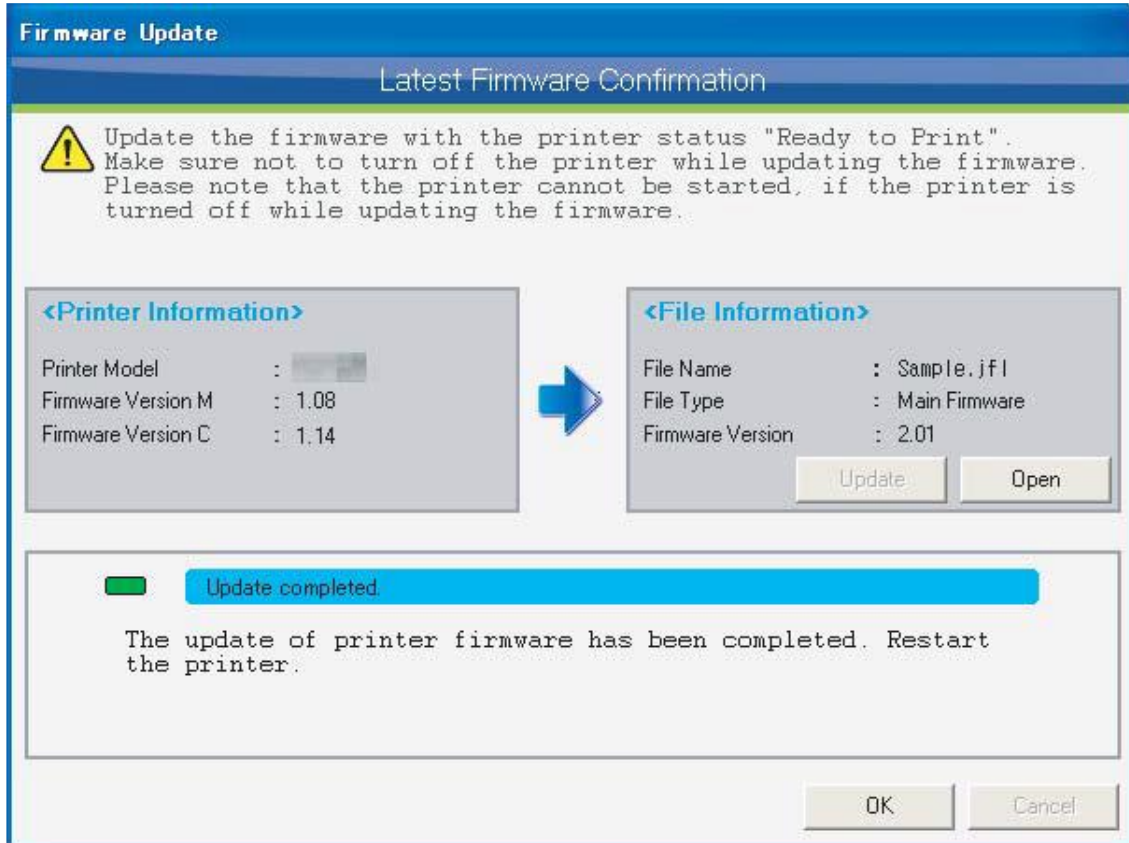

NOTE

- Even the firmware update is completed, the printer is still in the update mode. Therefore, make sure to restart the printer.

6.2.5 Printer Information Backup

Save the printer information on a disk.

When consulting your dealer on an error occurred in the printer, this printer information helps them to analyze the cause of the error in advance and smoothly solve the problem.

When requested from your dealer, use this function to save the printer information on your computer disk and send it to your dealer by e-mail.

NOTE

- Depending on an error or conditions of the printer, MSM may not be able to obtain printer information from the printer.
-

6.2.6 Printer Information Upload

With an internet connection to the MUTOH Club server, upload the printer information to the server.

When using MSM online, by sharing the printer information via MUTOH Club with your dealer to ask help for error on the printer, they can analyze the cause of the error in advance and smoothly solve the problem.

When requested from your dealer, use this function to upload the printer information to the MUTOH Club server.

NOTE

- To use this function, use MSM with internet connection and log in to MUTOH Club.
-

6.2.7 Exit (MSM Minimize)

Minimize the MSM. To redisplay the MSM, click the MSM icon on the task tray. Refer to the "4.2 Task Tray Icon" for details.

7. Status monitor

The status monitor displays status information from the printer.

No.	Name	Description
1	Printer Information	Basic monitored information from the printer will be displayed. Refer to "7.1 Printer Information" for details.
2	Detailed Information	If an error has been detected with the printer, possible causes and the solution will be displayed. Refer to "7.2 Detail Information" for explanation.
3	Status Information	The status information of printer will be displayed. Refer to "7.3 Status Information" for details.
4	Smart/C Information	Printer Smart/C information will be displayed. Refer to "7.4 Smart/C Information" for details.
5	Heater Information	Heater information of the printer will be displayed. Refer to "7.5 Heater Information" for details.
6	Head / Cartridge Information	The print head and cartridge information of the printer will be displayed. Refer to "7.6 Head/Cartridge Information" for details.
7	S/C Card Information	S/C Card information of the printer will be displayed. Refer to "7.7 S/C Card Information" for details.
8	Media Information	Media information of the printer will be displayed. Refer to "7.8 Media Information" for details.
9	Print Information	Print information of the printer will be displayed. Refer to "7.9 Print Information" for details.





NOTE

- Functionality varies according to printer model.

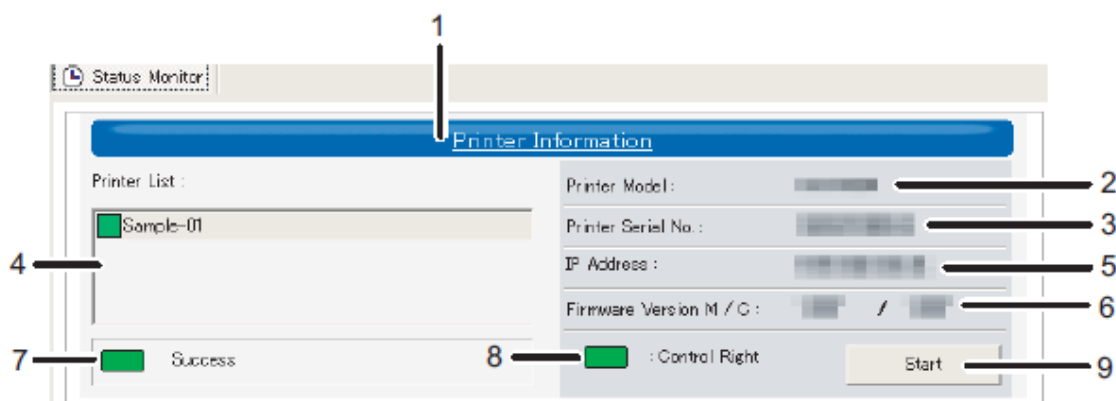
7.1. Printer Information

Basic information for monitored printers will be displayed.



No.	Name	Description
1	Printer information (Display/Hide detailed information)	Click the printer information label to display or hide the detailed information. For details regarding display/ hide, refer to the "7.1.1 Display the Details Information".
2	Printer Model Name	Displays the model name of the printer that has been monitored.
3	Printer Serial Number	Displays the serial number of the printer that has been monitored.
4	Printer List	A list of registered printers will be displayed; the communication status of each printer will also be displayed. The registration name that you specified during registration will be displayed on the list.  : Communication Succeeded  : Occurrence of Error  : Occurrence of warning
5	IP Address	Displays the IP address of the printer that has been monitored.
6	Firmware Version	Displays the firmware version of the printer that has been monitored. M : Main C : Controller
7	Communication Status	Displays the communication status of the printer that has been monitored.
8	Control Right	Displays the control right of the printer that has been monitored.  : Control Right Exists  : Control Right Does Not Exist
9	Start	Obtains printer information.

7.1.1 Display the Details Information

Specify whether to display the detailed information or not.

Info: OFF

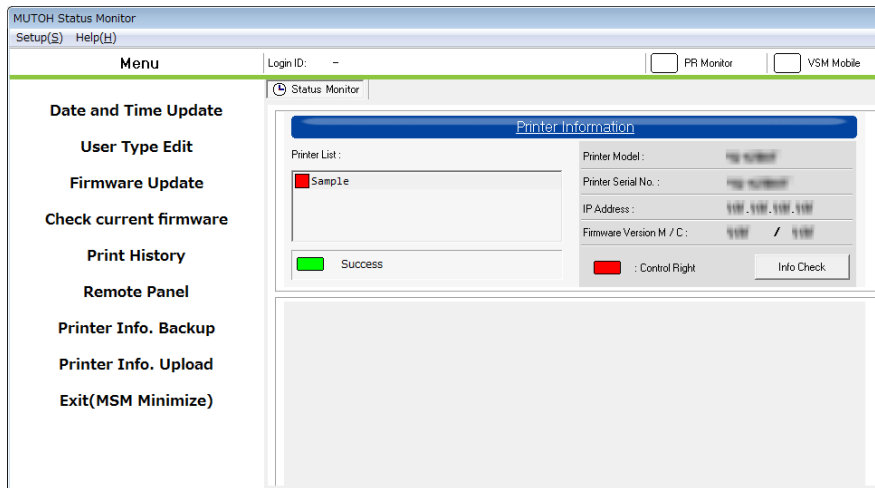

Info: ON(*Default)

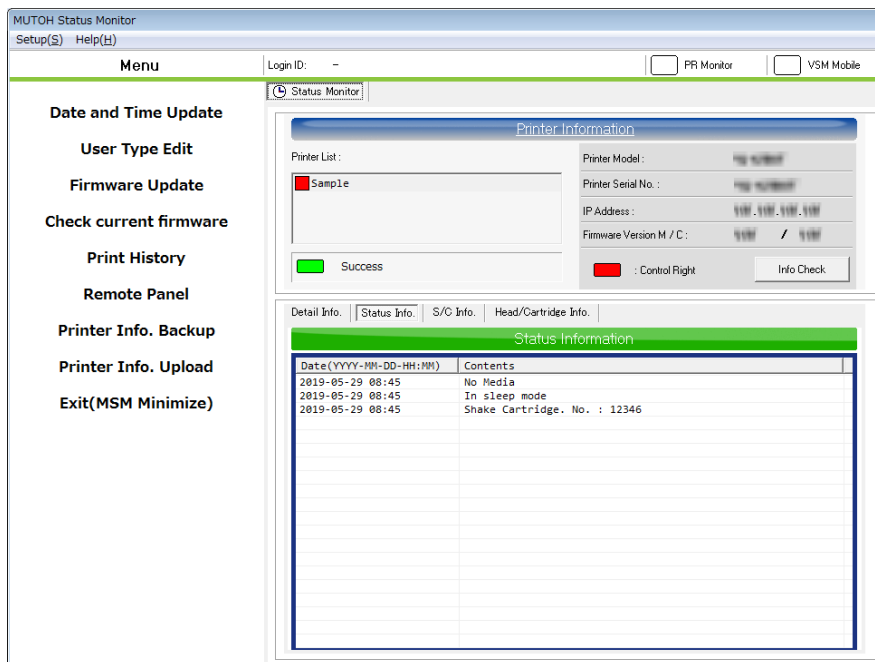

7.2. Detail Information

Displays information regarding communication errors with a monitored printer.

Error causes will be displayed. Please resolve errors using content information.

Ex. The printer is OFF.



7.3. Status Information

The status information of printer under monitoring will be displayed.

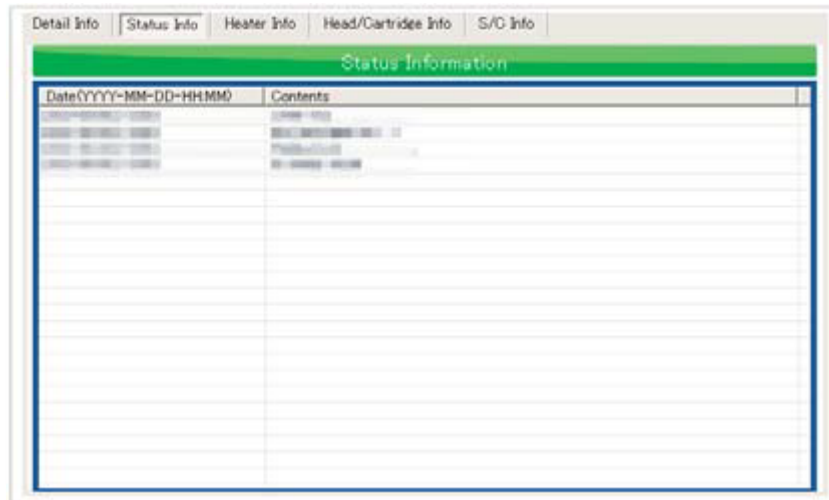

Date(YYYY-MM-DD-HHMM)	Contents
2011-01-01-00:00:00	Printer is ready
2011-01-01-00:00:00	Printer is ready
2011-01-01-00:00:00	Printer is ready
2011-01-01-00:00:00	Printer is ready
2011-01-01-00:00:00	Printer is ready
2011-01-01-00:00:00	Printer is ready
2011-01-01-00:00:00	Printer is ready
2011-01-01-00:00:00	Printer is ready
2011-01-01-00:00:00	Printer is ready
2011-01-01-00:00:00	Printer is ready
2011-01-01-00:00:00	Printer is ready
2011-01-01-00:00:00	Printer is ready
2011-01-01-00:00:00	Printer is ready
2011-01-01-00:00:00	Printer is ready
2011-01-01-00:00:00	Printer is ready
2011-01-01-00:00:00	Printer is ready
2011-01-01-00:00:00	Printer is ready
2011-01-01-00:00:00	Printer is ready
2011-01-01-00:00:00	Printer is ready
2011-01-01-00:00:00	Printer is ready
2011-01-01-00:00:00	Printer is ready
2011-01-01-00:00:00	Printer is ready

7.4. Smart/C Information

Displays Smart/C information for a printer that has been monitored.

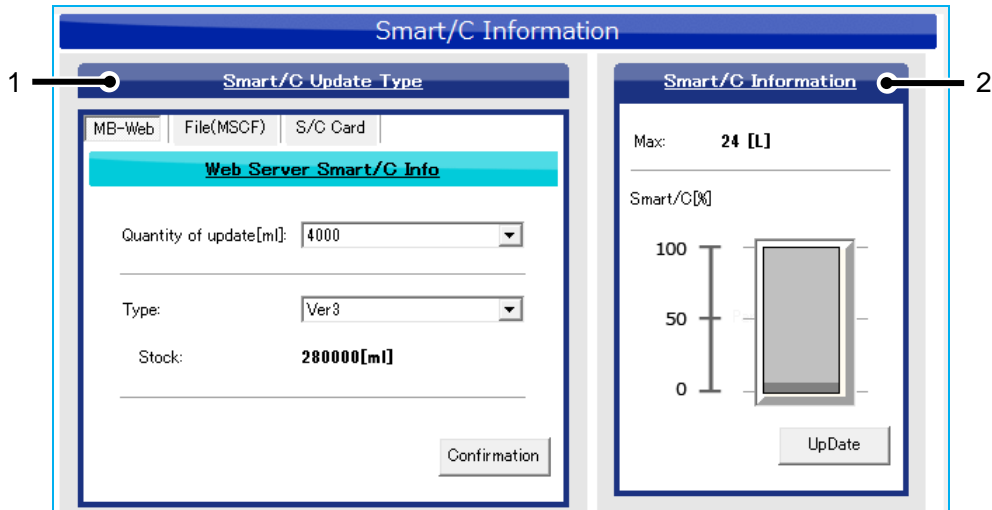

No.	Name	Description
1	Smart/C Update Type	The type of Smart/C to be updated will be displayed. Refer to the "7.4.1 Update the Smart/C with MB-Web" and the "7.4.2 Update the Smart/C with the Update File (MSCF)" for details.
2	Smart/C Information	Displays Smart/C information for a printer that has been monitored. Refer to the "7.4.4 Smart/C Information" for details.

7.4.1 Update the Smart/C with MB-Web

Obtain and display Smart/C information available via an Internet connection from MUTOH Club.

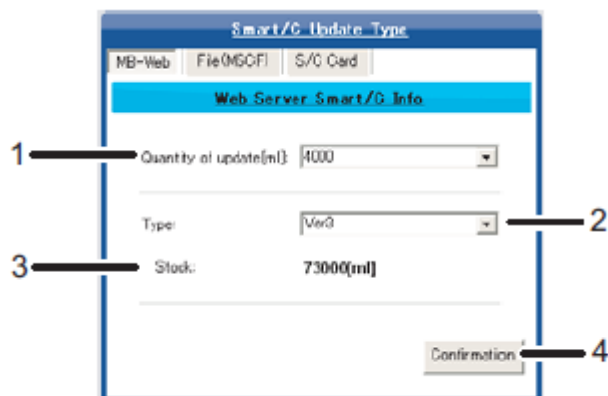

No.	Name	Description
1	Quantity of Update [ml]	Select the quantity of Smart/C to update. * The selectable quantity of update varies according to printer model.
2	Type	Select the type of Smart/C to update.
3	Stock	Displays the stock of the Smart/C that is selected in No. 2. * If the quantity of stock is less than the quantity of update, the update cannot be executed.
4	Confirmation	Obtain the latest Smart/C information from MUTOH Club. * This information cannot be obtained without login to MUTOH Club.

NOTE

- This function may not be available depending on the model.
- This tab can only be displayed only when "Internet connection is available" is selected in the Internet connection setting.

7.4.2 Update the Smart/C with the Update File (MSCF)

The MSCF information will be displayed.

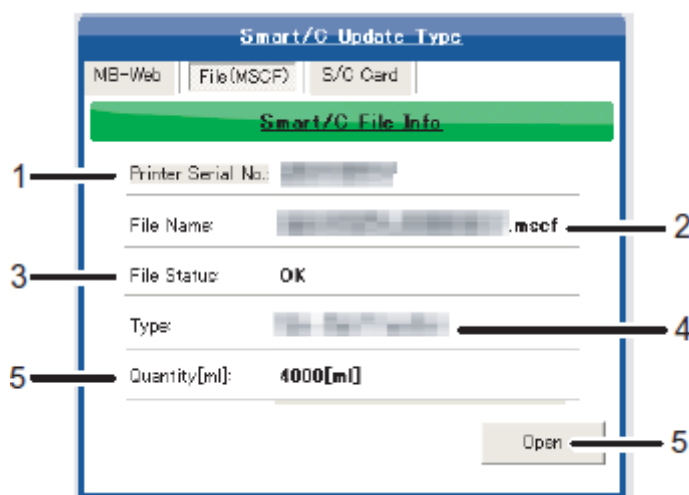

No.	Name	Description
1	Printer Serial No.	Displays the serial number of the monitored printer.
2	File Name	Displays the file name of the loaded MSCF.
3	File Status	Displays the status of the loaded MSCF. The status will be detected as an error according to conditions. *If the MSCF is not for the appropriate printer *If the MSCF is already updated
4	Type	Displays the type of Smart/C for the loaded MSCF.
5	Quantity [ml]	Displays the quantity of Smart/C for the loaded MSCF in ml.
6	Open	Select the MSCF to load.

NOTE

- This function may not be available depending on the model.
- MSCF : Smart/C Update File

7.4.3 Update the Smart/C with S/C Card

S/C card information will be displayed.

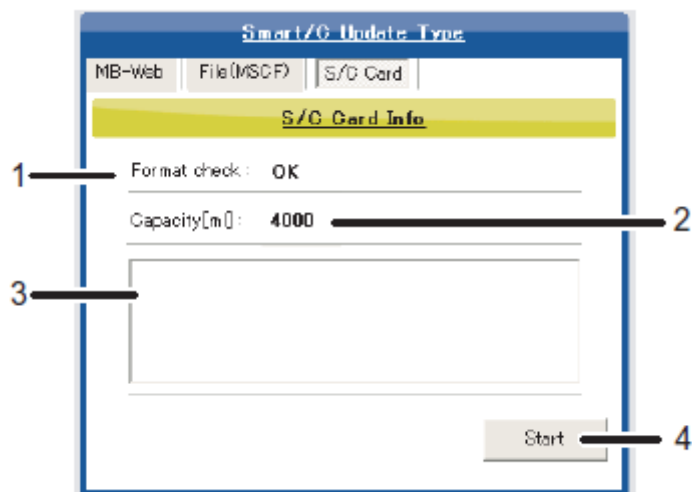

No.	Name	Description
1	Format check	The status of the read S/C card will be displayed.
2	Capacity[m]	The capacity of the read S/C card will be displayed in ml.
3	Detail Information	The reason for the S/C card reading error will be displayed.
4	Start-Stop	Check and cancel the reading of S/C card.

NOTE

- This function may not be available depending on the model.
- Please use the S/C card reader and writer that we recommend.
S/C card reader and writer that we don't recommend cannot be used.
For S/C card reader and writer we recommend, please contact the dealer.

7.4.4 Smart/C Information

Displays the Smart/C information of the printer that has been monitored.

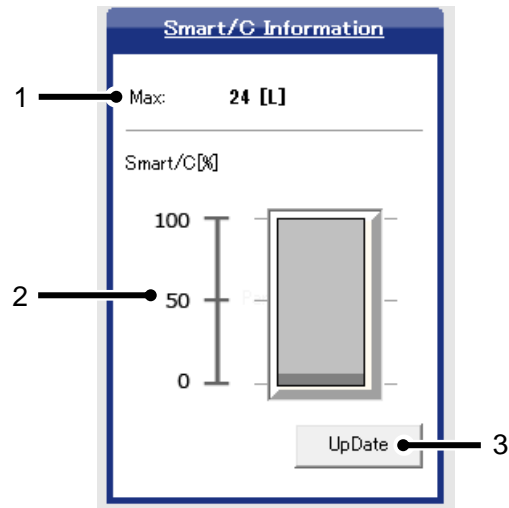

No.	Name	Description
1	Max	Displays the maximum Smart/C of the printer that has been monitored. * The Smart/C MAX varies according to printer model.
2	Smart/C Amount	Displays in % the remaining amount of Smart/C of the printer that has been monitored.
3	Update	Click the "Update" button to update to the Smart/C. Refer to the "7.4.4.1 Smart/C Update" for details.

7.4.4.1. Smart/C Update

When conditions for Smart/C update are met, the "Update" button will be available, then click the button to update the Smart/C.

NOTE

- To update the Smart/C with MUTOH Club, transfer the service information of the printer to the MB-Web.
- To update the Smart/C with the S/C card, make sure not to remove the S/C card during the update. If the S/C card is removed during the update, the Smart/C update will not be completed normally.
- The Smart/C cannot be updated unless all of the conditions below are met.

Update using MUTOH Club

- User login has been completed.
- The available quantity of Smart/C stock is sufficient.

Update using MSCF

- MSCF is valid.

Update the S/C card

- The S/C card is valid.

Common Condition





- The available quantity of Smart/C updates is within limits.
 - Control rights have been assigned.
-

7.5. Heater Information

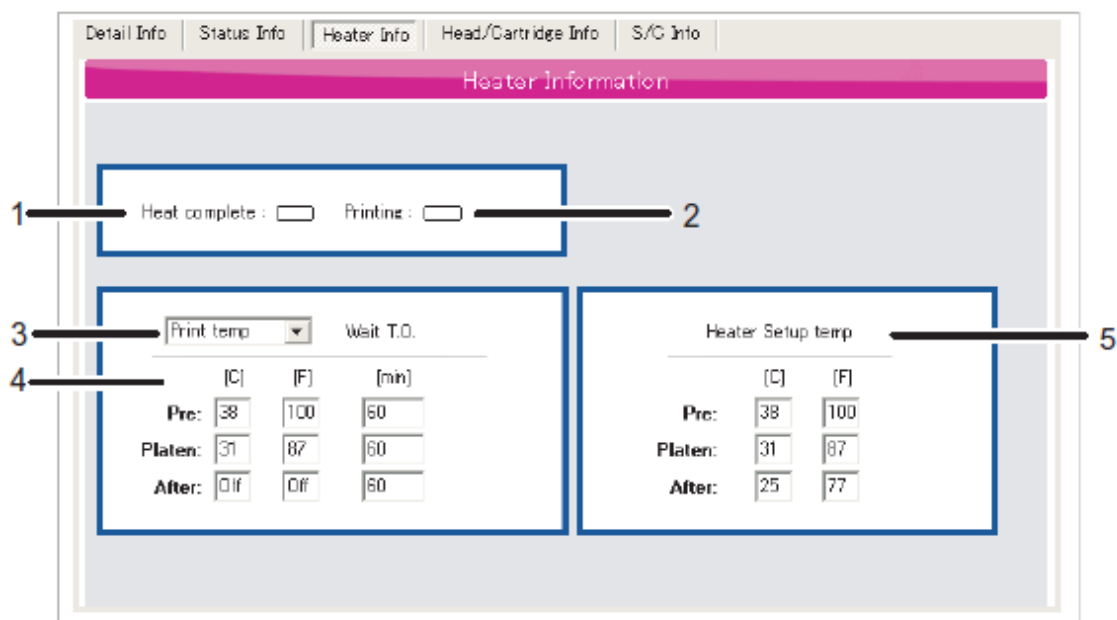
7.5.1 Heater Information

Checks information for Heater of printers that have been monitored.





No.	Name	Description
1	Heating Up Completed	When the thermistor reached to the preset temperature, the indication will be changed to green.  : Reached to the Preset Temperature  : Not Reached to the Preset Temperature
2	During Printing	When the printing is started after with the heating up completed, the indication will be changed to green.  : Printing  : Waiting
3	Type of Preset Temperature	Select the type of preset temperature. Printing Temperature:Temperature Setting for Printing Waiting Temperature:Temperature Setting for Waiting
4	Preset Temperature of Heaters	The temperature of each heater that is set by Type of Preset Temperature,standby heating will be displayed. Pre : Pre-Heater Platen : Platen Heater After : Dryer C : Celsius F : Fahrenheit
5	Temperature Condition	The actual temperature of each heater will be displayed. Pre : Pre-Heater Platen : Platen Heater After : Dryer C : Celsius F : Fahrenheit

7.5.2 Blower Heater Information

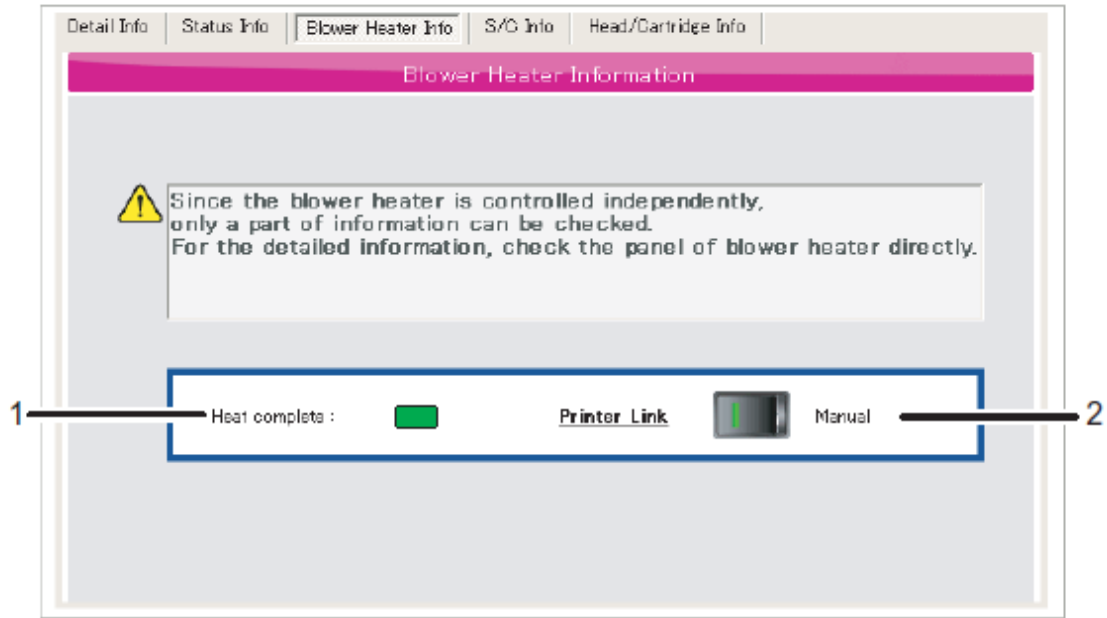
Checks information for Blower Heater of printers that have been monitored.





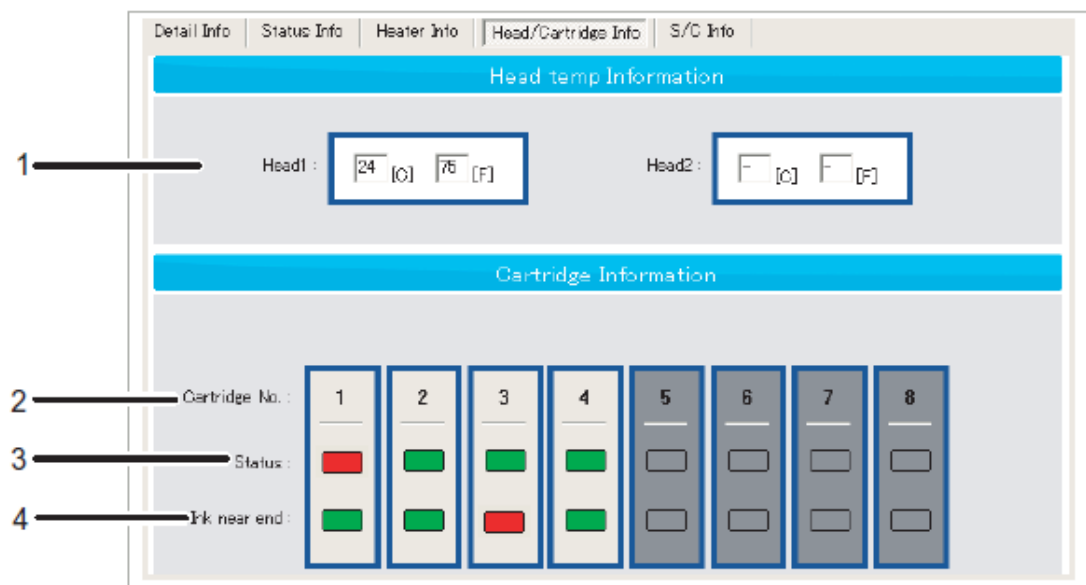

No.	Name	Description
1	Heating Up Completed	Displayed in green when the temperature reaches to the preset temperature.  : Reached to the Preset Temperature  : Not Reached to the Preset Temperature
2	Link	Display the operating method of heater. Printer Link : Operate in conjunction with the printer. Manual : Heater operates by itself

7.6. Head/Cartridge Information

Checks information for the print head and cartridge of printers that have been monitored.



No.	Name	Description
1	Print Head Temperature	Displays the print head temperature of printers that have been monitored. C: Celsius F: Fahrenheit * The number of head displayed varies according to printer model.
2	Cartridge No.	Displays the Cartridge No. * The number of cartridges displayed varies according to printer model.
3	Status	Displays the status of cartridges in the printer that have been monitored.  : Cartridge Inserted  : No Cartridge
4	Ink near end	The status of remaining ink amount is displayed.  : The remaining ink amount is enough.  : The remaining ink amount is low. *Not displayed depending on the model.

7.7. S/C Card Information

Checks information for S/C Card of printers that have been monitored.

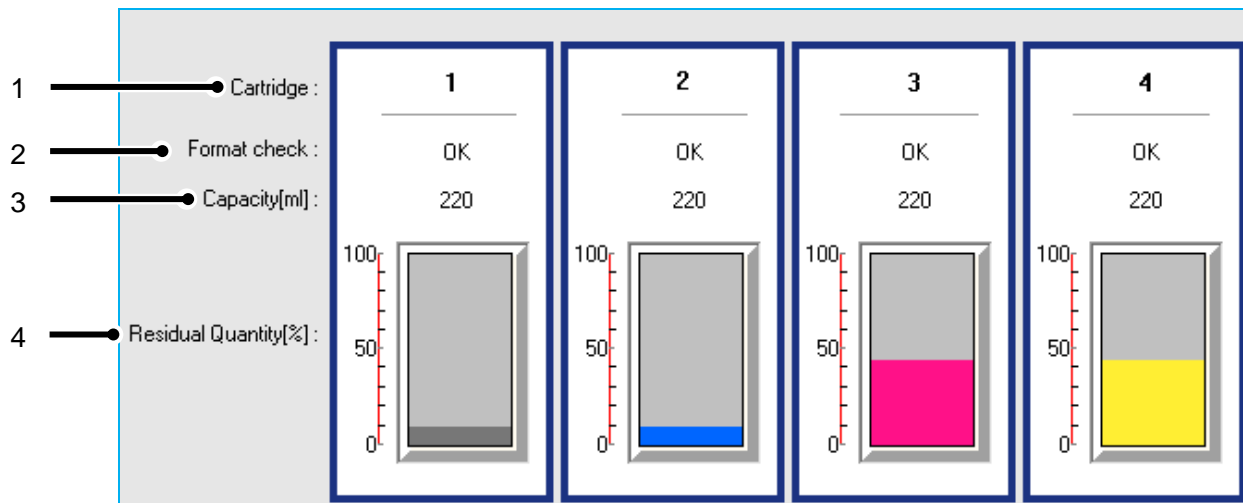

No.	Name	Description
1	No.	4 S/C are organized in 1 group.
2	Cartridge No.	The cartridge number of the printer, which has been monitored, will be displayed.
3	Format check	The S/C reading status of the printer, which has been monitored, will be displayed.
4	Color	The S/C color information of the printer, which has been monitored, will be displayed.
5	Capacity[ml]	The S/C ink capacity information of the printer, which has been monitored, will be displayed in "ml".
6	Residual Quantity[%]	The S/C remaining ink consume information of the printer, which has been monitored, will be displayed in % (1% basis).
7	Detailed Information	When a S/C card reading error occurs, put the mouse pointer over the "Reading" label to display the detail information. Refer to the "7.7.1 Format check" for details.

7.7.1 Format check

The S/C reading status of the printer, which has been monitored, will be displayed.

Name	Description
OK	Reading completed normally.
-	No Information.
Read Err 1	Cannot read the S/C card. Please check the S/C card.
Read Err 2	
Read Err 3	
Col. Err	The S/C card you have inserted is for different color. Insert the dedicated S/C card.
Ink Err	The S/C card you have inserted is unsupported. Insert the dedicated S/C card.
Code Err	
Ink End	The ink has run out. Please replace the ink
Broken Chip 1. - 28.	The S/C card you have inserted is broken, so the S/C card cannot be used.
Size Err	Cartridge size unsupported.

7.7.2 S/C Card Recovery

While recovering S/C card, printing is still possible, but the printer is unable to obtain information from the S/C card. The ink capacity and ink level in the cartridge/bag are not displayed correctly.

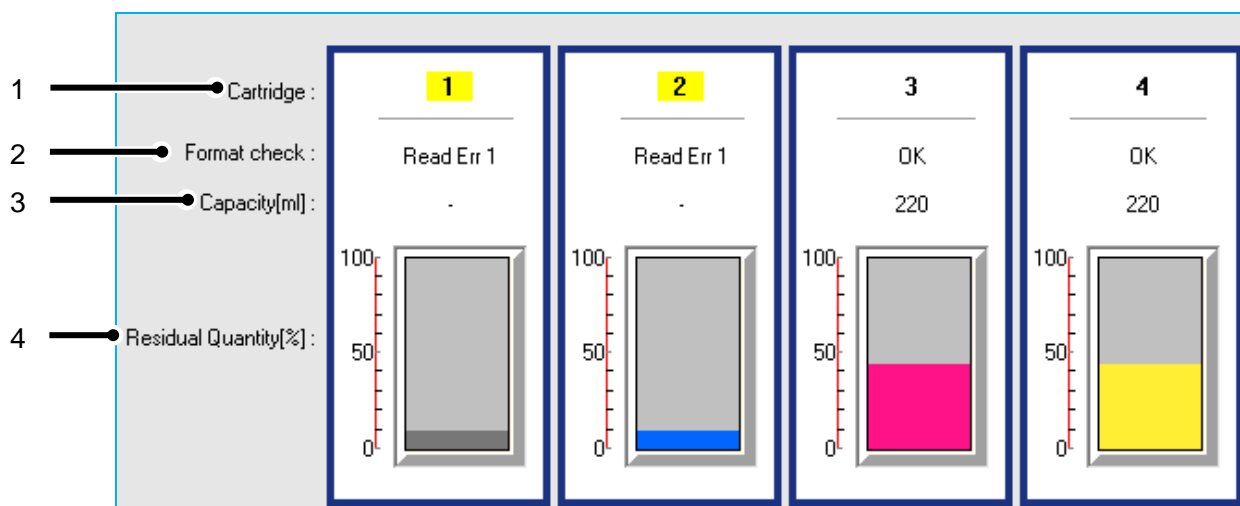

No.	Name	Description
1	Cartridge No.	The cartridge number is highlighted in yellow while in recovery state.
2	Format check	The S/C reading status of the printer, which has been monitored, will be displayed.
3	Capacity[ml]	In the recovery state, the display shows "-".
4	Residual Quantity[%] *1	In the recovery state, ink level is fixed to 10%.

NOTE

- *1 The ink level on the display is fixed to 10%. To check the actual ink level, an operator must physically check the amount of ink remaining in the cartridge/bag.
- The specification for S/C card recovery may vary by printer model. For details, see the latest printer's operation manual.

7.8. Media Information

The media information loaded in printer can be checked.

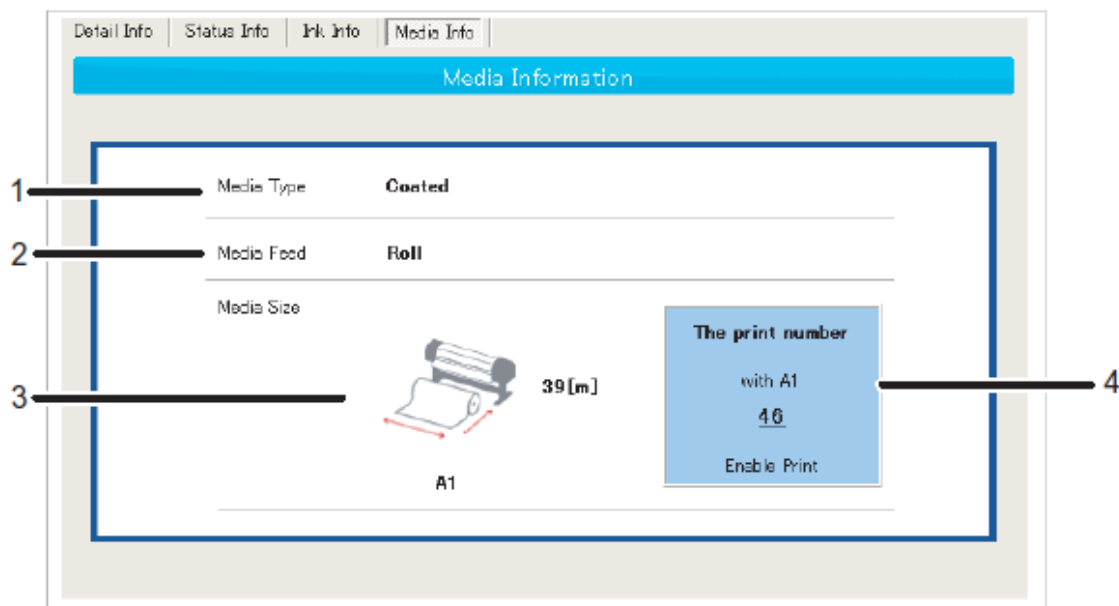

No.	Name	Description
1	Media Type	Display the media type loaded in printer.
2	Media Feed	Display the media feeding method loaded in printer.
3	Media Size	Display the media size loaded in printer.
4	The print number	Display the remaining printable number of media loaded in printer. * Valid only when the loaded media meet the conditions below: - Roll Media - Media with roll media management is valid * The printable number is an estimation.

NOTE

- Support only USB connection

7.9. Print Information

The previous print information can be checked.

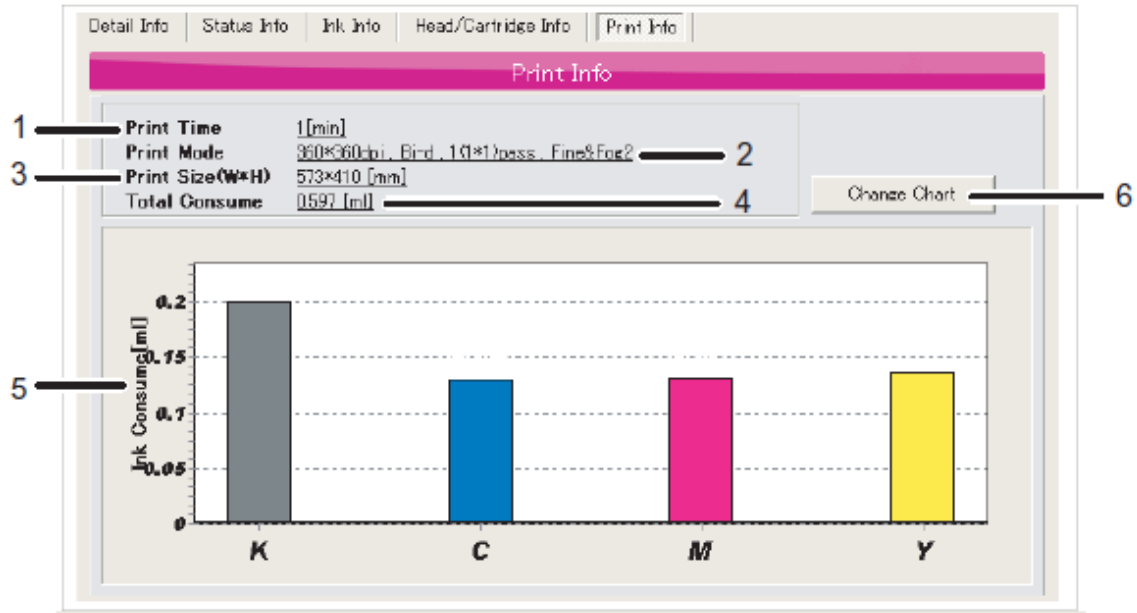

No.	Name	Description
1	Print Time	Display the time required for the previous print in minutes.
2	Print Mode	Display the settings for previous print.
3	Print Size (W * H)	Display the print size of previous print.
4	Total Consume	Display the total ink consumption of previous print.
5	Ink Consume	Display the ink consumption of each color for previous print.
6	Change Chart	Change the graph of ink consumption for previous print. * There are 2 types of graph.

1. Ink Consumption Graph

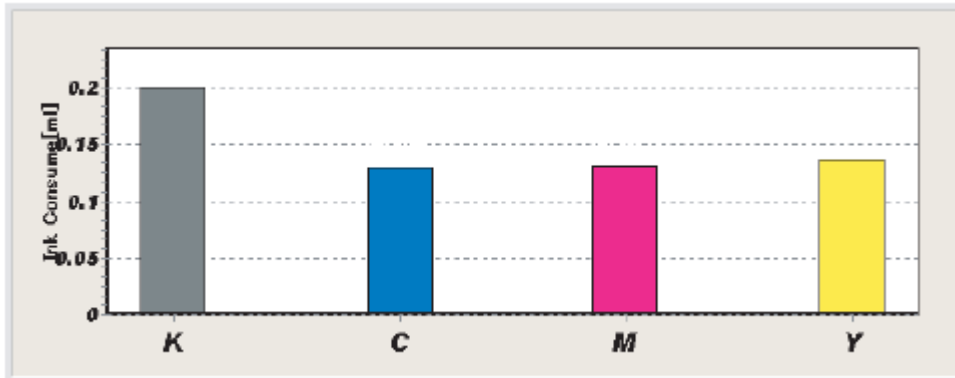

2. Ink Consumption Ratio Graph

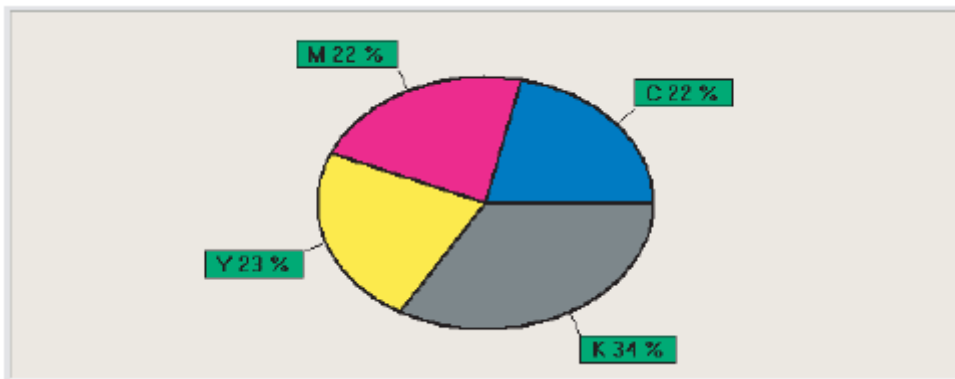

8. Activation

8.1. Execute Activation via the Internet

Printer registration is not available without activation.

Connect MSM to the Internet, MSM will automatically access MB-Web and execute activation.

1. When registering a printer with activation-unexecuted, the following message will be displayed. Click "OK" to execute activation.

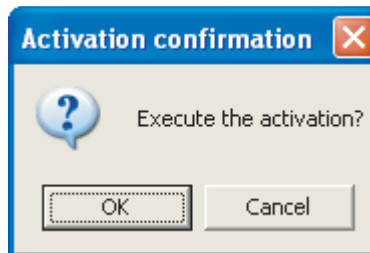

2. Click "Internet connection is available".

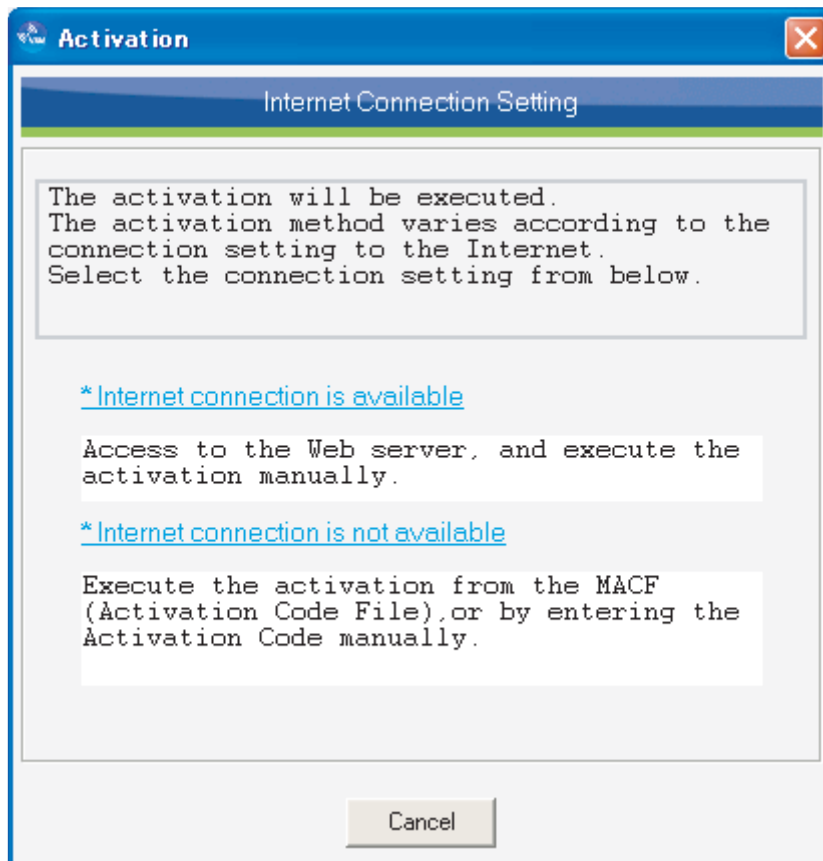

3. Accessing the MB-Web to obtain the "Activation Code" and executing Activation. Please wait.

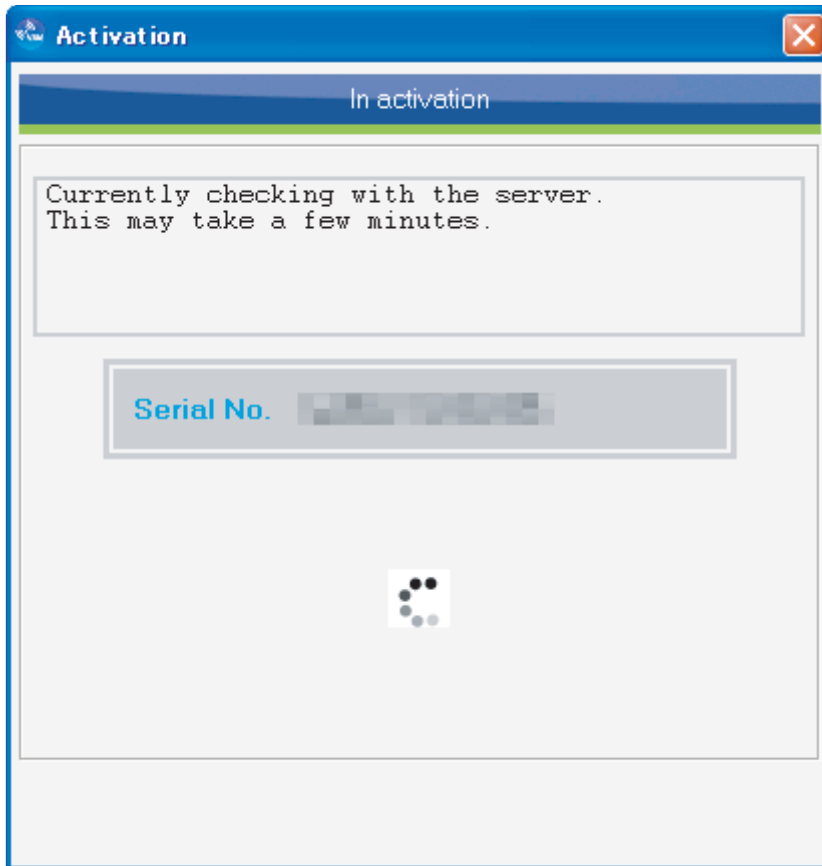

4. When activation is complete, the following window appears.

NOTE

- When activation is complete, service information from the printer will be registered to MUTOH Club.
- If an activation execution error occurs, contact your dealer and inform them of the "ErrCode".
- Once activation is completed, restart the printer.

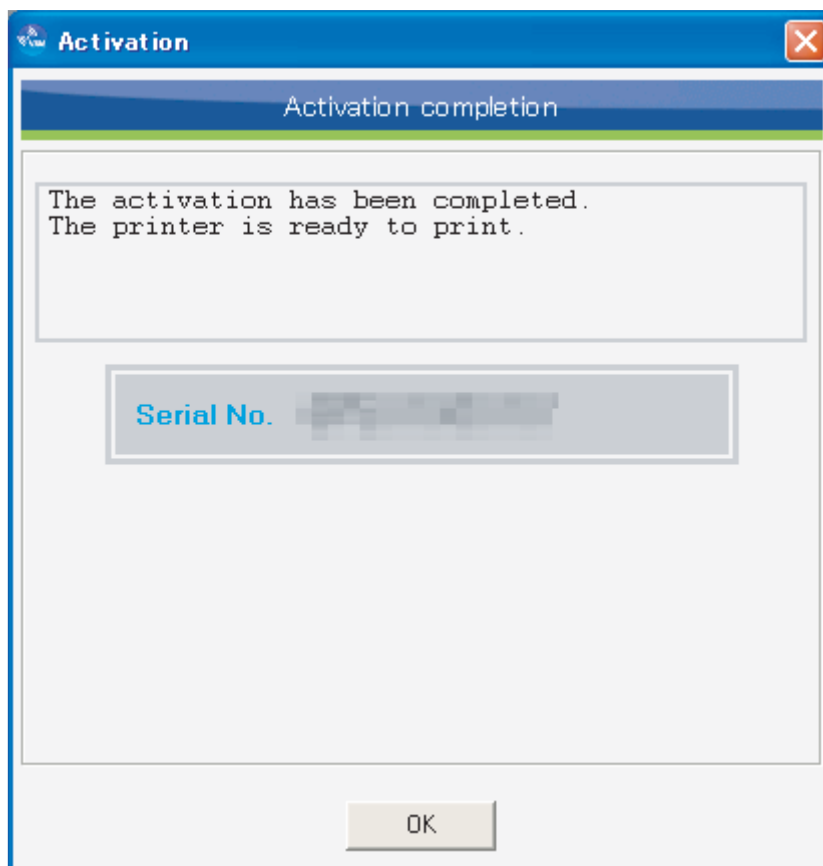

8.2. Execute Activation By Entering “Activation Code”

Printer registration is only available when the printer executes activation. If you do not access to the Internet, ask your dealer to issue an activation code or activation code file in order to execute activation.

1. When registering a printer with activation-unexecuted, the following message will be displayed. Click "OK" to execute activation.

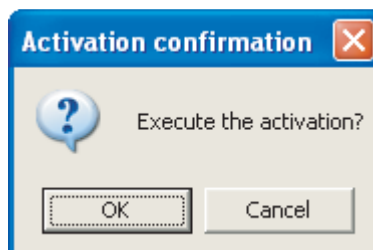

2. Click "Internet connection is not available".

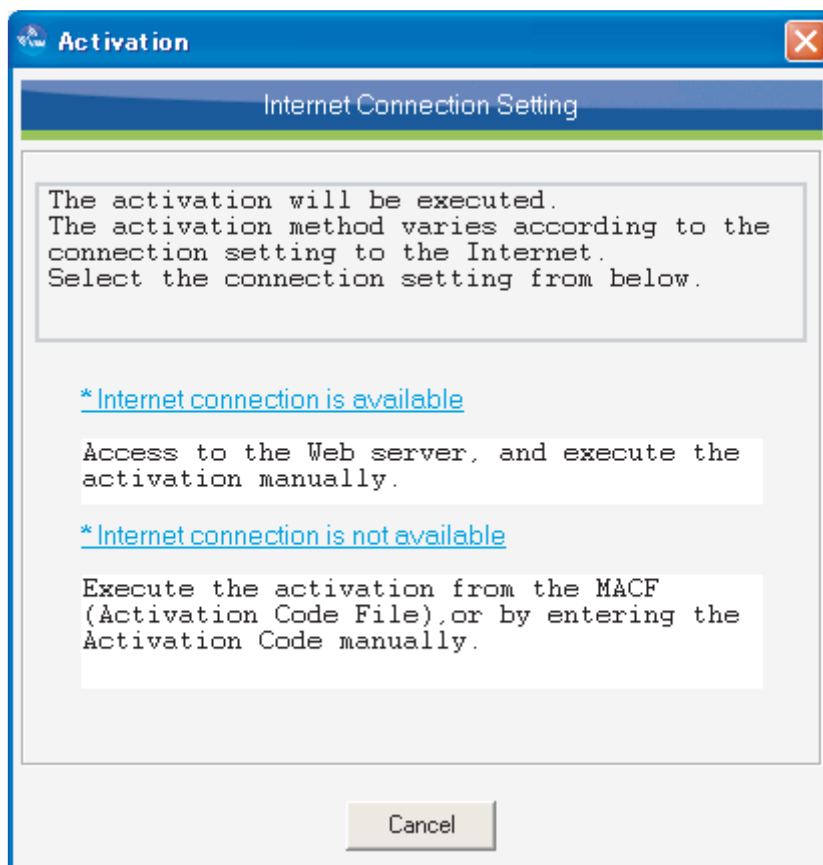

3. Enter the activation code issued by your dealer and click "Execution". In order to execute activation with an activation code file, click the folder icon and select the file.

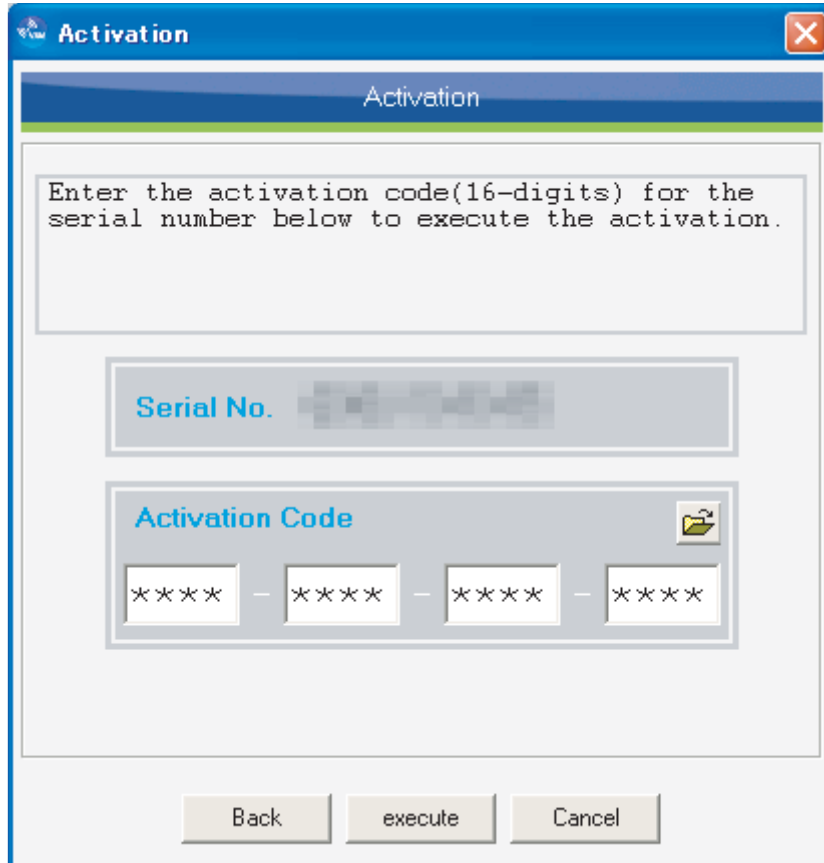

4. When activation is complete, the following window will appear.

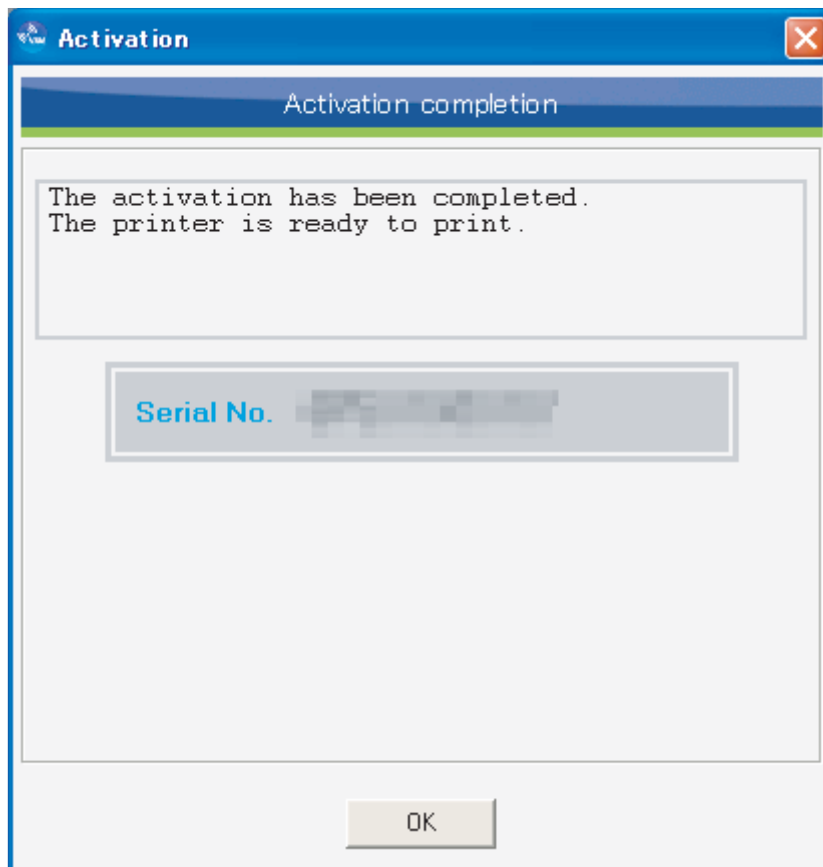
**NOTE**

- If an activation execution error occurs, contact your dealer and provide the "ErrCode".
- Once activation is complete, restart the printer.

9. Report Mail

When an error or warning occurs with the printer under monitoring, the notification mail will be sent to the specified mail address.

Configure the settings in the order of printer, mail address, functions and mail contents to send the notification mail.

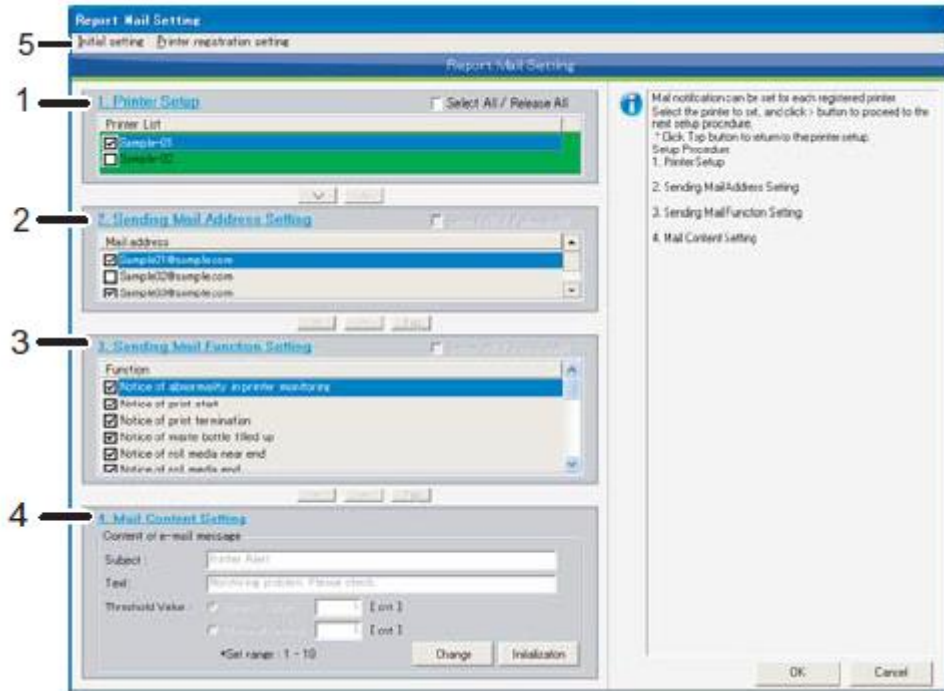

No.	Name	Description
1	Printer Setup	Set the mail notification function of registered printer to "Valid / Invalid" Refer to the "Printer Setup" for details. Refer to the "9.1 Printer Setup" for details.
2	Sending Mail Address Setting	Set the mail address for sending the notification mail to "Valid / Invalid" for each printer. Refer to the "9.2 Sending Mail Address Setting" for details.
3	Sending Mail Function Setting	Set the function to send for each printer and mail address to "Valid / Invalid". Refer to the "9.3 Sending Mail Function Setting" for details.
4	Mail Content Setting	Set the details of mail content to send for each printer.. Refer to the "9.4 Mail Content Setting" for details.
5	List of Settings	Configure the settings required to use the notification mail function. Refer to the "9.5 List of Settings" for details.

9.1. Printer Setup

Specify the notification mail function to "Valid / Invalid" for the registered printer.

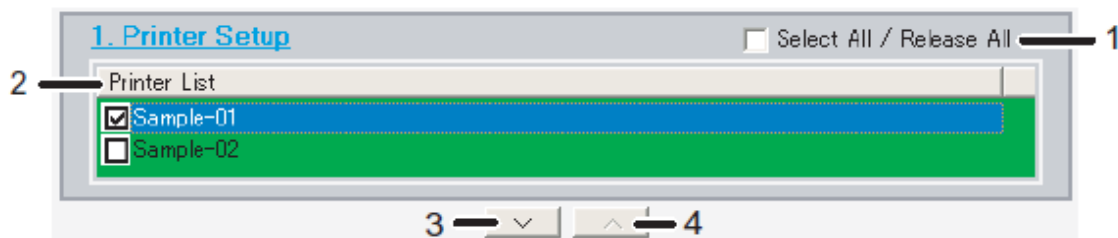

No.	Name	Description
1	Select All / Release All	Change the select of all lists.
2	Printer List	This is the list of registered printers. Check the box for the printer name to setup the notification mail function. Check On : Notification Mail - Valid Check Off : Notification Mail - Invalid
3	Sending Mail Function Setting	Set the function to send for each printer and mail address to "Valid / Invalid". Refer to the "7.4.4 Smart/C Information" for details.
4	Next	Select the printer to set, and shift the next step.
5	Back	Return to the printer setup.

9.2. Sending Mail Address Setting

Specify the mail addresses to send the notification mail to "Valid / Invalid" for each printer.

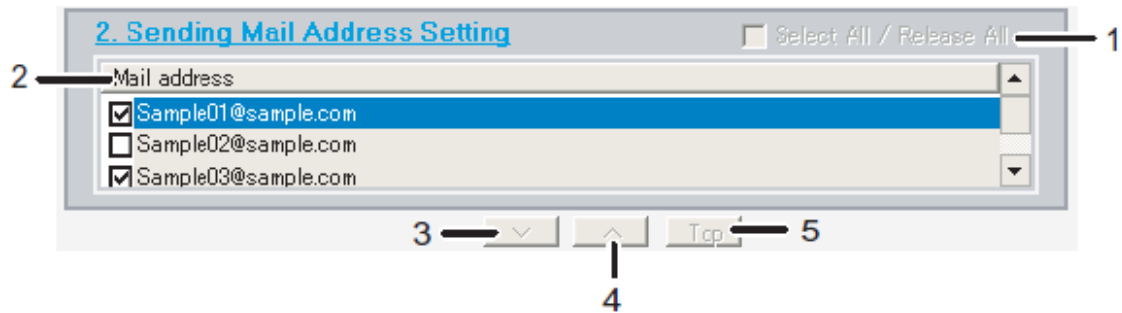

No.	Name	Description
1	Select All / Release All	Change the select of all lists.
2	Mail address	This is the list of registered mail addresses. Check the box for the mail address to setup the notification mail function. Check On : Notification Mail - Valid Check Off : Notification Mail - Invalid
3	Next	Select the mail address to set, and shift to the next step.
4	Back	Return to the sending mail address setting.
5	Return to Top	Return to the printer setup.

9.3. Sending Mail Function Setting

Specify the sending functions to "Valid / Invalid" for each printer and mail address.

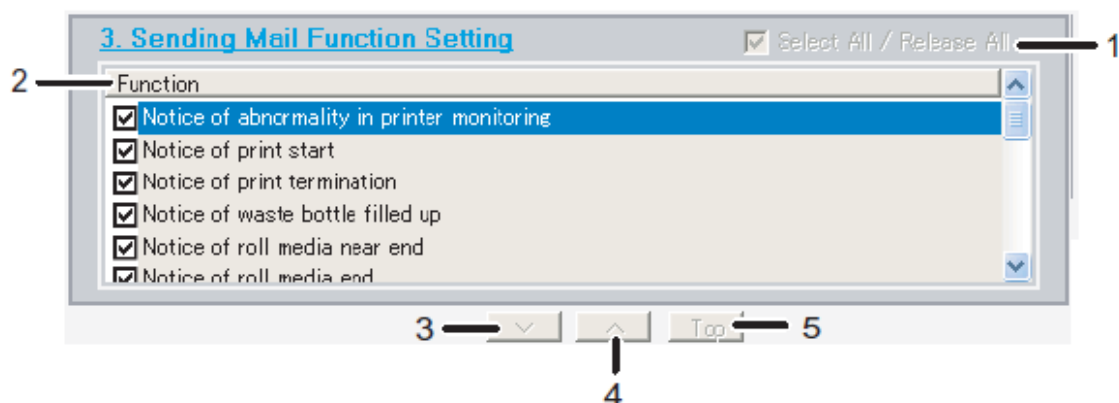

No.	Name	Description
1	Select All / Release All	Change the select of all lists.
2	Function	This is the list of sending mail functions. Check the box for the mail address to setup the notification mail function. Check On : Notification Mail - Valid Check Off : Notification Mail - Invalid Refer to the "9.3.1 Send Mail Function" for details.
3	Next	Select the functions to set, and shift to the next step.
4	Back	Return to the sending mail function setting.
5	Return to Top	Return to the printer setup.

9.3.1 Send Mail Function

List of sending mail functions

No.	Name	Description
1	Notice of abnormality in printer monitoring	Notification mail will be sent when the printer cannot communicate with MSM by an error.
2	Notice of print start	Notification mail will be sent when the printer started print.
3	Notice of print termination *2	Notification mail will be sent when the printer ended print.
4	Notice of waste bottle filled up *1	Notification mail will be sent when the waste ink bottle is filled up.
5	Notice of roll media near end *2	Notification mail will be sent when the remaining roll media is low. * Only when "Roll Media Length Setting" is specified.
6	Notice of roll media end	Notification mail will be sent when the roll media ends.
7	Notice of remaining ink near end *2	Notification mail will be sent when the remaining ink amount is low.
8	Notice of remaining ink end	Notification mail will be sent when the ink has run out.
9	Notice of Smart/C remaining amount near end *1	Notification mail will be sent when the remaining Smart/C is low.
10	Notice of Smart/C remaining amount end *1	Notification mail will be sent when the Smart/C has run out.
11	Notice of media skew error	Notification mail will be sent when the skew error has been detected.
12	Notice of media cut error *1	Notification mail will be sent when the S/C card error has detected.
13	Notice of S/C card error *1	Notification mail will be sent when the printer part reached to the lifetime.
14	Notice of life time occurrence	Notification mail will be sent when the stock of Smart/C in the MB-Web server is low.
15	Notice of Smart/C stock near end *1	Notification mail will be sent when the stock of Smart/C in the MB-Web server is low.
16	Notice of Smart/C stock end *1	Notification mail will be sent when the stock of Smart/C in the MB-Web server has run out.
17	Notice of firmware update completion	Notification mail will be sent when the update of printer firmware ended.
18	Notice of S/C ink near end *1,2	Notification mail will be sent when the remaining S/C ink amount is low.
19	Notice of S/C ink end *1	Notification mail will be sent when the S/C ink has run out.

NOTE

*1 The function is not supported depending on the printer.

*2 The function might be limited depending on the printer setup. When the function is limited, the notification mail will not be sent.

9.4. Mail Content Setting

The contents of mail to send can be changed for each printer.

No.	Name	Description
1	Subject	Change the title of mail to send.
2	Text	Change the content of mail to send. * The following information will be added automatically by the function. * Serial Number of the Printer * Detailed Information (Cartridge Number etc.)
3	Threshold Valuet	Change the threshold value to send e-mail. * This function is not supported in this version.
4	Change	Save the changed contents.
5	Initialization	Initialize the mail content.

NOTE

Make sure to click the "Change" button to change the setting.

The setting will not be reflected without clicking the "Change" button.

9.4.1 Threshold Value

Specify the standard threshold value to send e-mail.

The e-mail will be sent when the printer reaches to each threshold value.

The threshold value setting will be available or unavailable depending on the function.

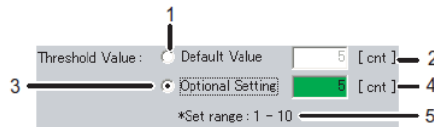

No.	Name	Description
1	Default Value	Specify the value to send the e-mail in the default setting.
2	Default Value	When the default value is selected, the value will be the threshold value to send the e-mail. The default value differs depending on the printer model.
3	Optional Setting	Specify the setting to send the e-mail in the arbitrary setting.
4	Arbitrary Setting Value	When the arbitrary setting is selected, the value will be the threshold value to send the e-mail. The setting value can be input arbitrarily in each setting range. * Refer to the "Table 9.4.1. Threshold Value - Function / Setting Range Chart" for the details.
5	Set range	Setting range that can be specified in the arbitrary setting. * Refer to the "Table 9.4.1. Threshold Value - Function / Setting Range Chart" for the details.

Table 9.4.1. Threshold Value - Function / Setting Range Chart

Name		Setting Range		Default Value
		Minimum	Maximum	
Notice of abnormality in printer monitoring		1 [cnt]	10 [cnt]	5 [cnt]
Notice of roll media near end		1 [m]	10 [m]	*1
Notice of remaining ink near end		25 [ml]	1000 [ml]	*1
Notice of Smart/C remaining amount near end	Normal	20 [ml]	1000 [ml]	*1
	High-capacity	1000 [ml]	10% of maximum capacity	*1
Notice of Smart/C stock near end		100 [ml]	8000 [ml]	1000 [ml]

*1 Differ from the printer model.

NOTE

The control right is required to change the threshold value

9.5. List of Settings

Configure the settings needed to use the notification mail function.

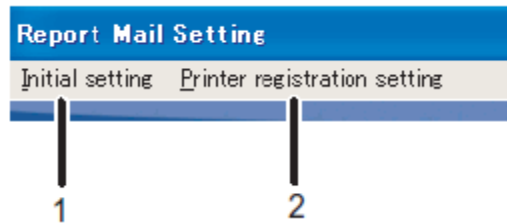

No.	Name	Description
1	Initial setting	Perform the initial setting for the MSM. * Refer to "3.Initial Setting" for the details.
2	Printer registration setting	Register the printer to be monitored by MSM. * Refer to "3.9.1 Register the printer information" for the details.

NOTE

The notification mail will not be sent without the settings above.

10. ColorVerify

Printer color reproduction can change over time due to various factors, including environmental (shop temperature and humidity), age and storage conditions of ink and media, possible lot-to-lot manufacturing variations of ink and media, and aging of the printer itself (due to mechanical wear). Individually, such factors may have minimal impact on color reproduction, but cumulatively over a span of time these factors can lead to color variations that become apparent and potentially detrimental to image quality.

The 'Color Verify' feature can be utilized to aid the printer operator in checking for and isolating potential color reproduction variations before they become a visual detriment.

In this function, 14 color patches are printed, and the colors are measured by the optional spectrophotometer (SPECTROVUE VM-10). If the Color Verify was performed before and the measured value was saved as the baseline, the color difference from the baseline will be printed as a result.

NOTE

- The optional SPECTROVUE VM-10 is required to perform this function.
- Before performing this function, make sure to print the nozzle check pattern to check if there is no missing nozzle.
- In order to perform the Color Verify correctly, make sure to specify the following settings same as the setting when the baseline was saved. If these settings are different, the color difference may become large.
 - * Each Heater Temperature Setting, Effect Setting, CR Print Width Setting, Overwrite Setting
- Use this function with the head height adjustment lever is in the "Low" position.
- The 'Color Verify' feature is intended to be utilized as an aid to the printer operator in checking for and isolating potential color reproduction variations that can arise over time due to various factors common to all printing environments; it is a tool intended to help facilitate implementation of on-printer process control.

As such, it is not in-and-of-itself a guarantee of color reproducibility or reproduction accuracy, nor does it negate the need for color workflow best practices.
- Since the room environment (temperature, humidity) may affect the print color, create the environment in accordance with the environment condition described in the operating manual "8.1.1 Printer Specification" "Environment Condition". In addition, make sure to place the media and ink in the printing environment for 2 hours before use.
- In this function, the color difference (dE) is calculated based on CIE 94*.
 - * CIE94 is proposed by CIE (International Commission of Illumination) in 1994.
- The Windows firewall for File Transfer Program (ftp.exe) needs to be deactivated to execute this function.

For details, refer to "10.2.15 Windows Firewall".
- The printer model, which was launched after the end of life of VM-10, does not support this function.

10.1. History

The history of Color Verify will be displayed.

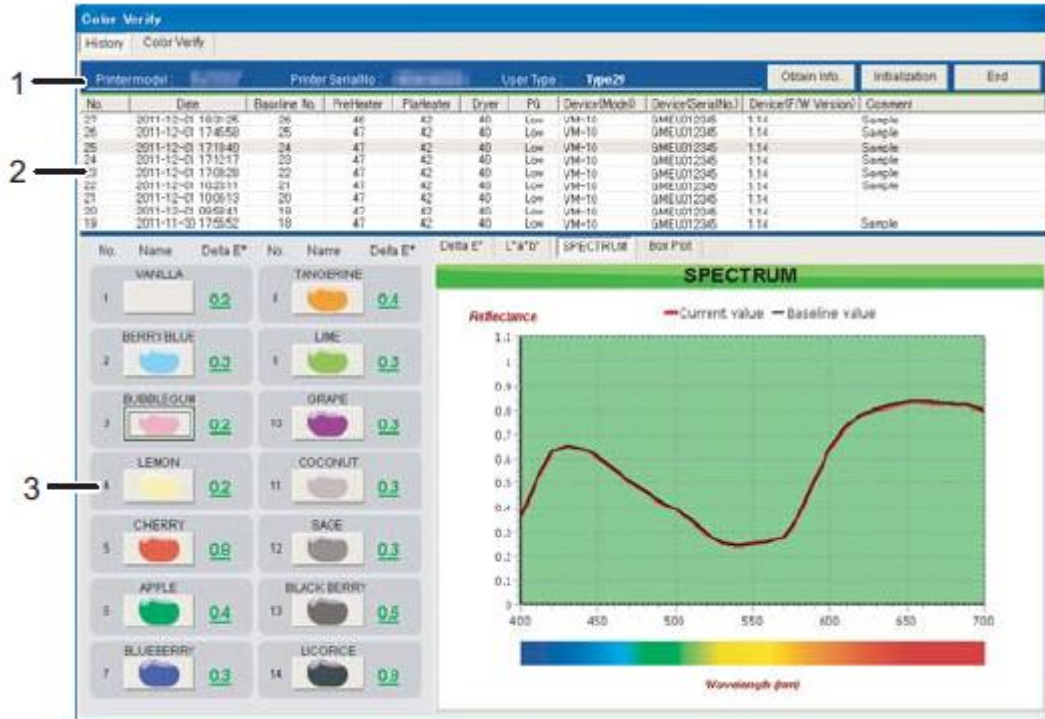

No.	Name	Description
1	Printer Information	The printer information will be displayed. * For details, refer to "10.1.1 Printer Information"
2	History List	The list of Color Verify history will be displayed. * For details, refer to "10.1.2 History List".
3	Detail Information	The detail information of Color Verify will be displayed. * For details, refer to "10.1.3 Detail Information".

10.1.1 Printer Information

The printer information will be displayed.



No.	Name	Description
1	Printer model	The printer model will be displayed.
2	Printer Serial No.	The serial number of printer will be displayed.
3	User Type	The user type specified for printer will be displayed.
4	Obtain Information	Obtain the latest printer information.
5	Initialization	Initialize the history information.
6	End	Stop the Color Verify.

10.1.2 History List

The history of Color Verify will be displayed in the list.

No.	Date	Baseline No.	PreHeater	PlaHeater	Dryer	PG	Device(Model)	Device(SerialNo.)	Device(F/W Version)	Comment
27	2011-12-01 18:3:25	26	47	42	40	Low	VM-10	GMELK012345	1.14	Sample
28	2011-12-01 17:48:56	29	47	42	40	Low	VM-10	GMELK012345	1.14	Sample
25	2011-12-01 17:18:40	24	47	42	40	Low	VM-10	GMELK012345	1.14	Sample
24	2011-12-01 17:11:17	23	47	42	40	Low	VM-10	GMELK012345	1.14	Sample
23	2011-12-01 17:08:28	22	47	42	40	Low	VM-10	GMELK012345	1.14	Sample
22	2011-12-01 16:29:11	21	47	42	40	Low	VM-10	GMELK012345	1.14	Sample
21	2011-12-01 16:26:13	20	47	42	40	Low	VM-10	GMELK012345	1.14	Sample
20	2011-12-01 09:59:41	19	47	42	40	Low	VM-10	GMELK012345	1.14	Sample
19	2011-11-26 17:56:52	18	47	42	40	Low	VM-10	GMELK012345	1.14	Sample

No.	Name	Description
1	No.	The data No. of Color Verify will be displayed.
2	Date	The date when Color Verify was executed will be displayed.
3	Baseline No.	The baseline No. will be displayed. * When the baseline is not specified, "-" will be displayed.
4	PreHeater	The pre heater temperature specified for Color Verify will be displayed.
5	PlaHeater	The platen heater temperature specified for Color Verify will be displayed.
6	Dryer	The dryer temperature specified for Color Verify will be displayed.
7	PG	The head height specified for Color Verify will be displayed.
8	Device(Model)	The name of colorimeter will be displayed.
9	Device(SerialNo.)	The serial number of colorimeter will be displayed.
10	Device(F/W Version)	The F/W version of colorimeter will be displayed.
11	Comment	The comment entered for Color Verify will be displayed.

10.1.3 Detail Information

The detail information of Color Verify will be displayed.

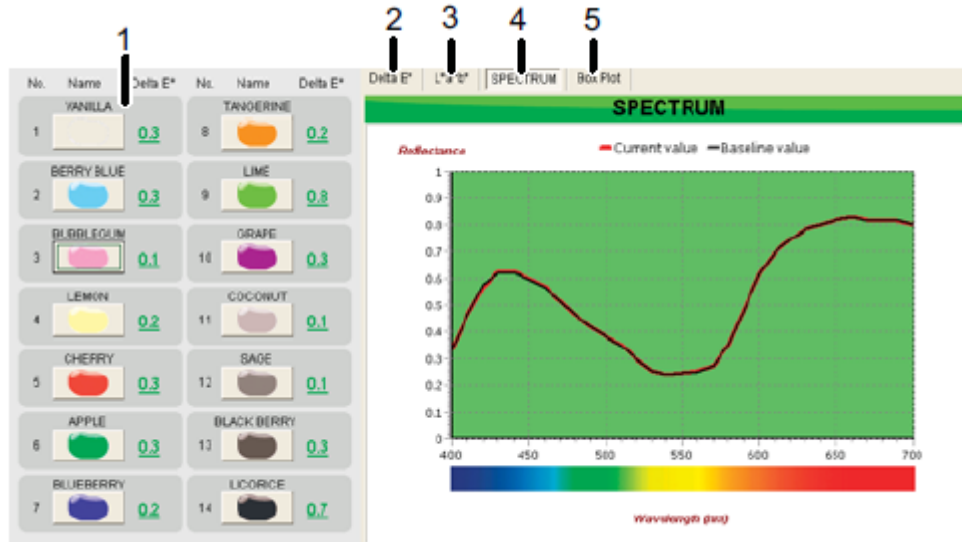

No.	Name	Description
1	Delta E*	The Delta E* information will be displayed. * For details, refer to "10.1.3.1 Delta E*".
2	Delta E* Graph	The Delta E* graph will be displayed. * For details, refer to "10.1.3.2 Delta E* Graph".
3	L*a*b* Graph	The L*a*b* graph will be displayed. * For details, refer to "10.1.3.3 *a*b* Graph".
4	SPECTRUM Graph	The SPECTRUM graph will be displayed. * For details, refer to "10.1.3.4 SPECTRUM Graph".
5	Box Plot	The box plot will be displayed * For details, refer to "10.1.3.5 BoxPlot".

10.1.3.1. Delta E*

The Delta E* information of each patch will be displayed.



No.	Name	Description
1	No.	The patch number will be displayed.
2	Patch Name	The patch name will be displayed. In addition, when the patch button is clicked, the patch name will be reflected to each graph and displayed in the graph.
3	Delta E*	The Delta E* information of patches will be displayed.

10.1.3.2. Delta E* Graph

The Delta E* graph information of 25 times of the latest Color Verify will be displayed.

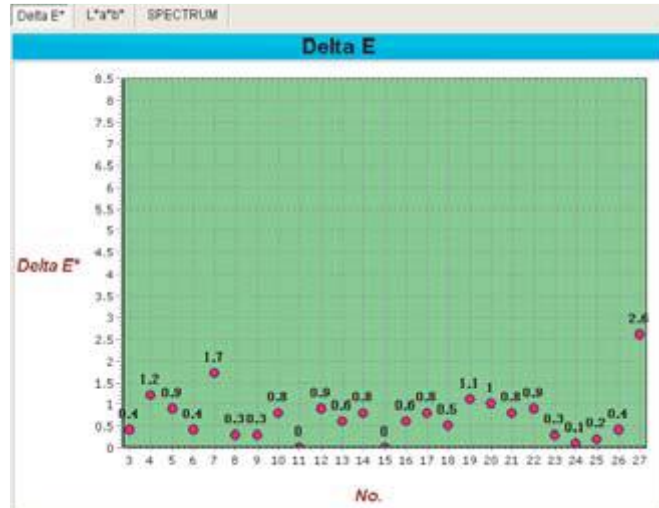

10.1.3.3. *a*b* Graph

The L*a*b* information of selected patch will be displayed.

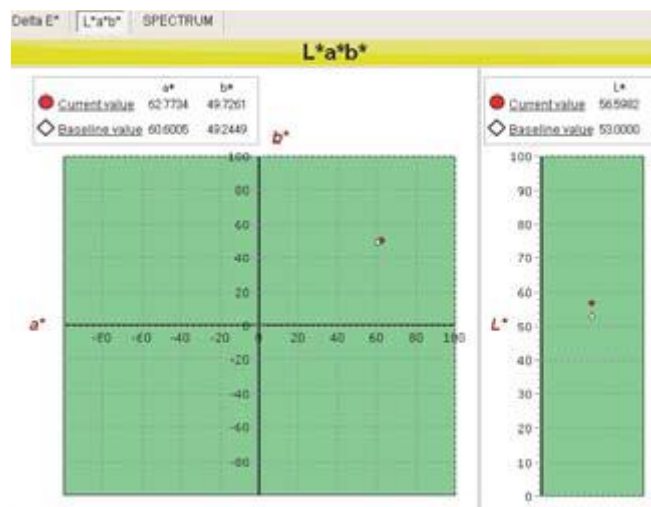

10.1.3.4. SPECTRUM Graph

The SPECTRUM information of selected patch will be displayed.

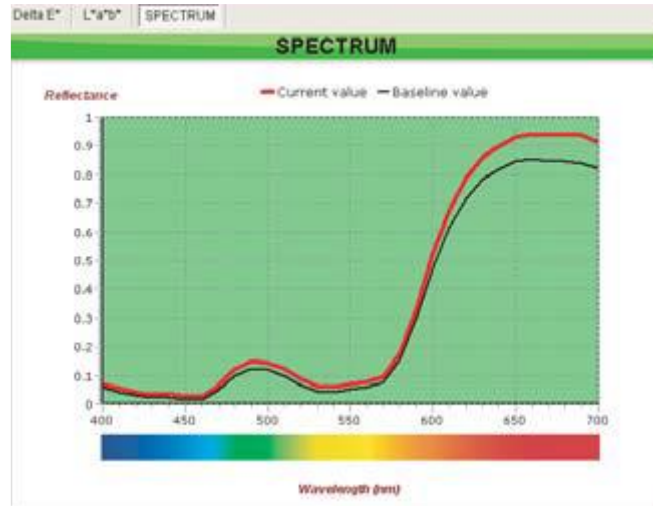

10.1.3.5. BoxPlot

Box plot is a graph to show the distribution of data simply.

Generally, a box plot has the following features.

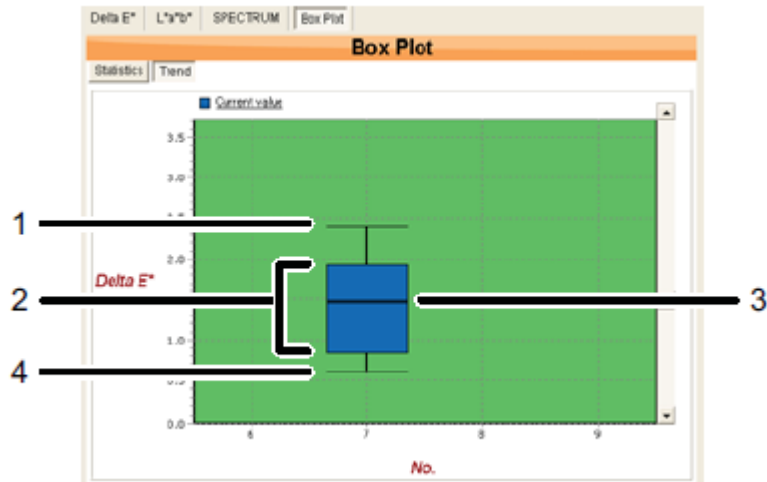

No.	Name	Description
1	Maximum	Shows the maximum value of data.
2	Box	Half of the data are distributed in the box range.
3	Medium	Middle value when the data is arranged from smallest to largest.
4	Minimum	Shows the minimum value of data.

(1)Statistics

The statistical information of the measured Delta E* value will be displayed by color.

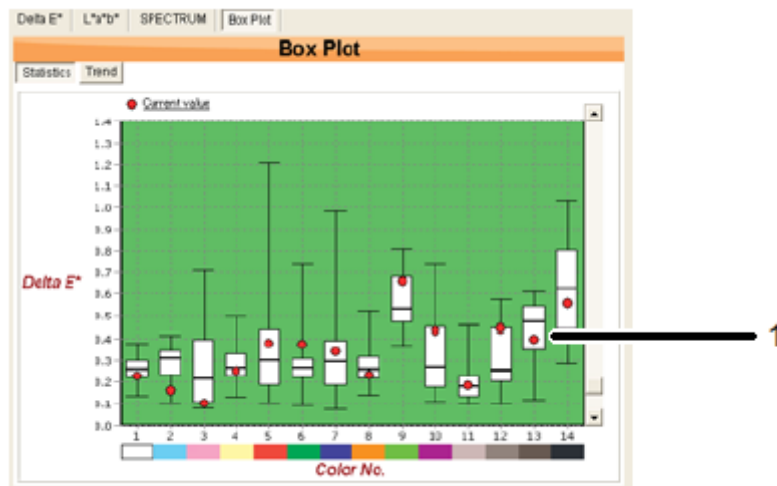

No.	Name	Description
1	Measured Value	The measured value selected in the list will be displayed.

NOTE

- If the measured value is in the box, the color is stable compared to the colors that are measured in the past.
- If the measured value is higher than the box, the color may be different from before. For the acceptance judgment, refer to the Delta E* value.
- Even if the measured value is lower than the box, there is no problem because the value is close to the baseline.
- To display the figure, more than 3 times of measurement at the same base line is required.

(2)Trend

The distribution of data will be displayed by each measurement.

From the variation in location and size of box, the tendency of color reproductively can be checked.

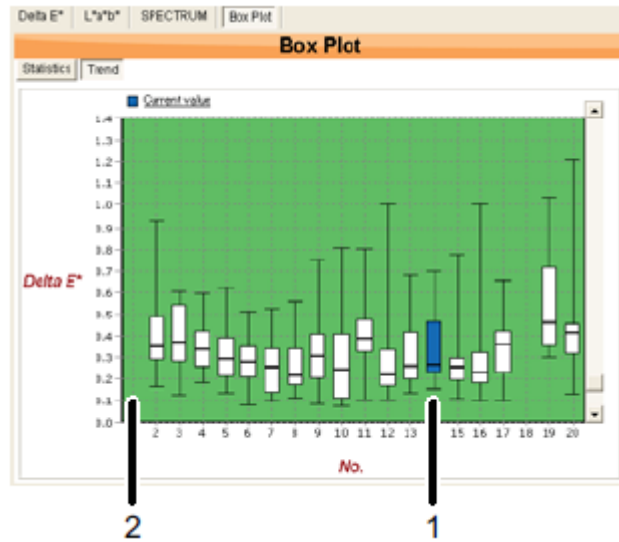

No.	Name	Description
1	Measured value	The measured value selected in the list will be displayed. The box of selected value will be shown in the different color.
2	Baseline value	The box will not be displayed.

NOTE

- If the delta E* values of several colors has increased without big change in the location of box:
The measurement may be failed due to uneven media and / or dust on the media surface. Please perform the measurement again.
- If the delta E* value is acceptable but the location of box is high:
The printing environment and setting may be different. Or, the media characteristic may be changed (e.g. the media color / dot gain has changed).
- To display the figure, more than 2 times of measurement at the same base line is required.

10.2. Color Verify

Execute the Color Verify.

Follow the procedures and check the notes below to perform the Color Verify.

NOTE

- The optional SPECTROVUE VM-10 is required to perform this function.
- To perform this function, make sure that the remaining amount of ink and media is enough and follow the instructions of operation panel and MSM.
- While the printer is in operation, the Color Verify is not executed. Make sure that "Ready to Print" is displayed on the operation panel.
- The 'Color Verify' feature is intended to be utilized as an aid to the printer operator in checking for and isolating potential color reproduction variations that can arise over time due to various factors common to all printing environments; it is a tool intended to help facilitate implementation of on-printer process control.

As such, it is not in-and-of-itself a guarantee of color reproducibility or reproduction accuracy, nor does it negate the need for color workflow best practices.

10.2.1 Configuration

To execute Color Verify, select a baseline from the history list, and click "Start" button.

If the baseline is not selected, the baseline will be created and the Delta E will not be displayed.

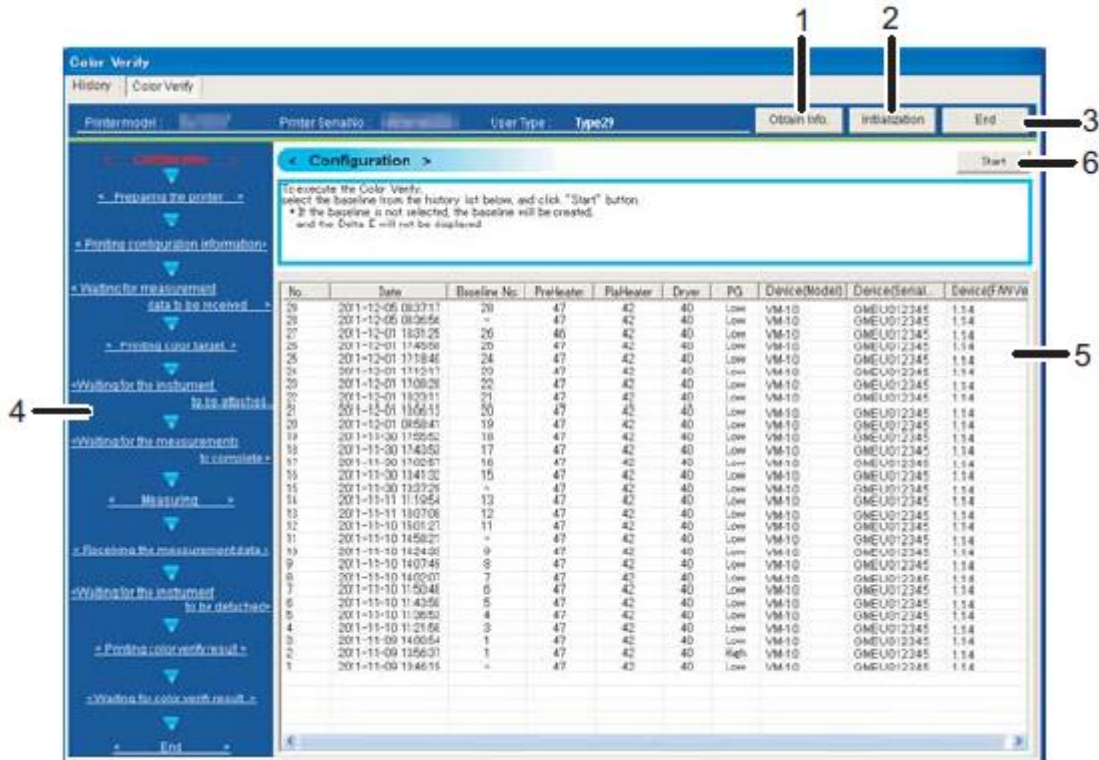

No.	Name	Description
1	Obtain Information	Obtain the latest printer information.
2	End	Stop the Color Verify.
3	Progress of Color Verify	The progress of Color Verify will be displayed. The current progress will be displayed in red letter.
4	History List	The list of Color Verify history will be displayed. To execute Color Verify, select a baseline from the list.
5	Start	Select a baseline, and start Color Verify.

10.2.2 Preparing the printer

The printer is in preparation to execute Color Verify.

When the printer preparation is completed, the printer proceeds to the next step automatically. Please wait for a while.



No.	Name	Description
1	Progress of Color Verify	The progress of Color Verify will be displayed.
2	Detail	The detail information will be displayed according to the progress.
3	History List	Click "Stop" button to stop the Color Verify. When the Color Verify is stopped, the result will not be saved in the history. * For details, refer to "10.2.14 Stop".

NOTE

While the printer is in operation, the Color Verify is not executed.

10.2.3 Printing configuration information

The printer is printing a setup data.

When the printing is completed, the printer proceeds to the next step automatically. Please wait for a while.

10.2.4 Waiting for measurement data to be received

The printer is waiting for patch data to receive.

The patch data will be printed automatically by MSM. Please wait for a while.

10.2.5 Printing color target

The printer is printing a patch data.

When the printing is completed, the printer proceeds to the next step automatically.

Please wait for a while.

10.2.6 Waiting for the instrument to be attached

When the patch data is printed, follow the instructions on operation panel to attach the colorimeter to the printer.

10.2.7 Waiting for the measurements to complete

When the colorimeter is attached to the printer, the printer will be the color measurement waiting status.

Press "Enter" key on the operation panel, or click "Start Measurement" button on MSM to start the color measurement.

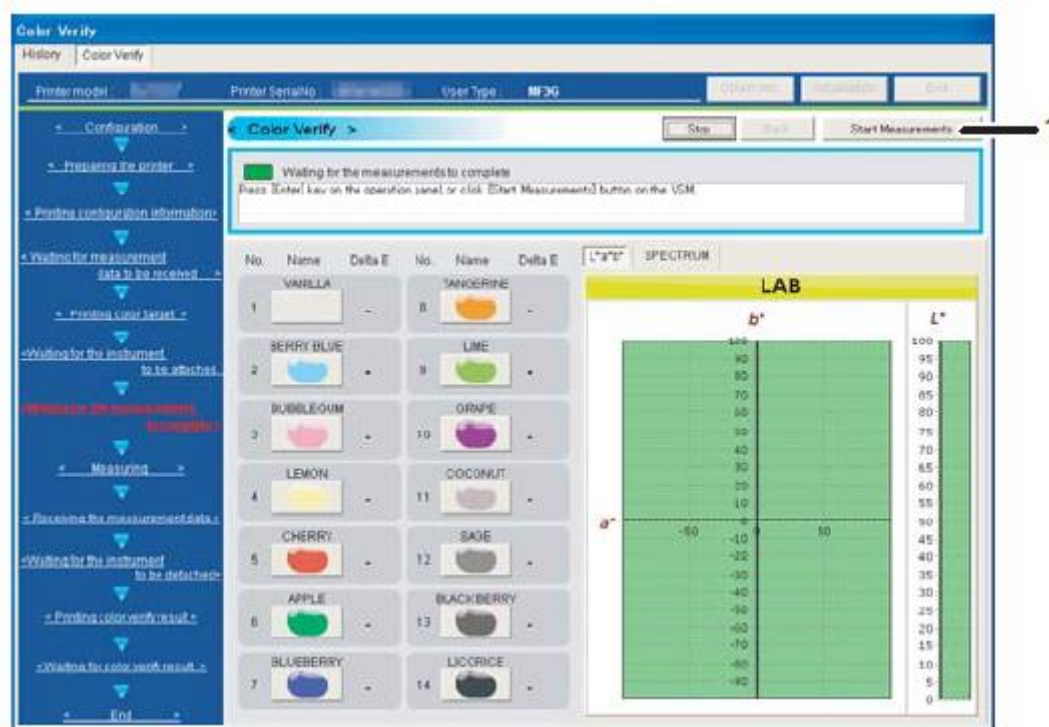

No.	Name	Description
1	Start Measurements	Start the color measurement.

10.2.8 Measuring

The printer is measuring the patches.

When the color measurement is completed, the printer proceeds to the next step automatically.

Please wait for a while.

10.2.9 Receiving the instrument to be detached

When the color measurement is completed, the measurement result will be obtained from the printer.

When the measurement result is obtained completely, the printer proceeds to the next step automatically.

Please wait for a while.

10.2.10 Waiting for the instrument to be detached

When the measurement result is obtained from printer, the result will be displayed on MSM.

Follow the instructions on operation panel to remove the colorimeter from the printer.

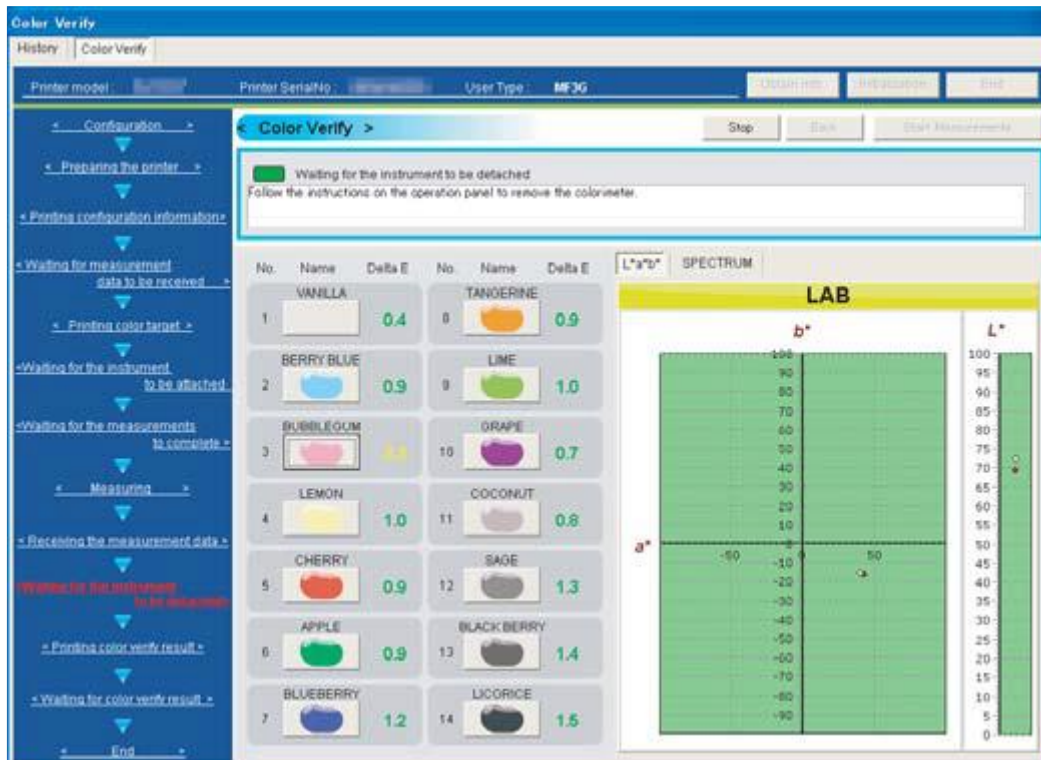

10.2.11 Printing color verify result

The printer is printing the measurement result of Color Verify.

When the printing of Color Verify result is completed, the printer proceeds to the next step automatically.

Please wait for a while.

10.2.12 Waiting for color verify result

Check the printed Color Verify result, and press "Enter" key on the operation panel.

The screenshot displays the 'Color Verify' software interface. On the left, a vertical navigation menu lists various steps from 'Configuration' to 'End'. The main window is titled 'Color Verify' and shows a status bar with printer information (Printer model, Serial No., User Type: MF30) and buttons for 'Stop', 'Back', and 'Start Measurement'. A central message box indicates 'Waiting for color verify result' and instructs the user to 'Check the color measurement result, and press [Enter] key on the operation panel.' Below this, a table lists 14 color targets with their names and Delta E values. To the right, a 'LAB' color chart is visible, showing a grid with axes for a^* , b^* , and L^* .

No.	Name	Delta E	No.	Name	Delta E
1	VANILLA	0.4	8	TANGERINE	0.9
2	BERRY BLUE	0.9	9	LIME	1.0
3	BUBBLEGUM	1.1	10	GRAPE	0.7
4	LEMON	1.0	11	COCONUT	0.8
5	CHERRY	0.9	12	SAGE	1.3
6	APPLE	0.9	13	BLACK BERRY	1.4
7	BLUEBERRY	1.2	14	LICORICE	1.5

10.2.13 End

To leave the Color Verify result on the history, enter the comment and click "Save" button. To exit the Color Verify without saving the result, click "End" button.

Click "Save" / "End" button to exit the Color Verify.

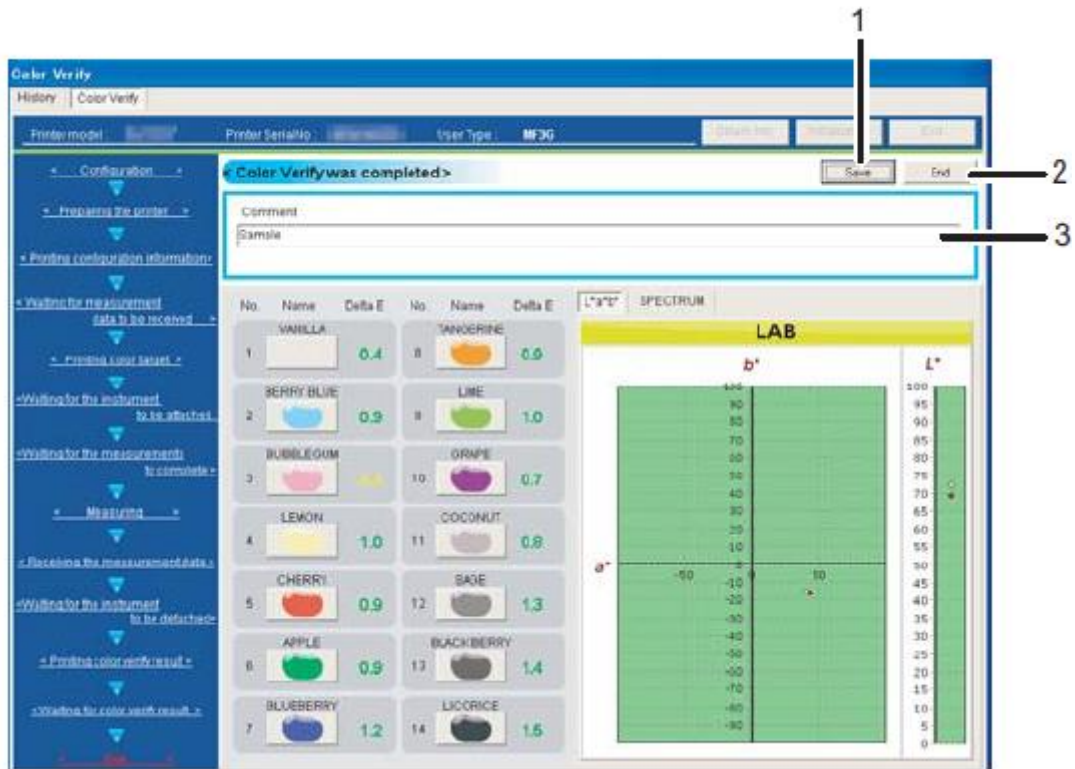

No.	Name	Description
1	Save	Click "Save" button to save the Color Verify result to the history. * Enter the comment to save the result.
2	End	Click "End" button to exit the Color Verify without saving the result.
3	Comment	Enter the comment to save the Color Verify result to the history.

10.2.14 Stop

Stop the Color Verify. When the Color Verify is stopped, the result will not be saved in the history.

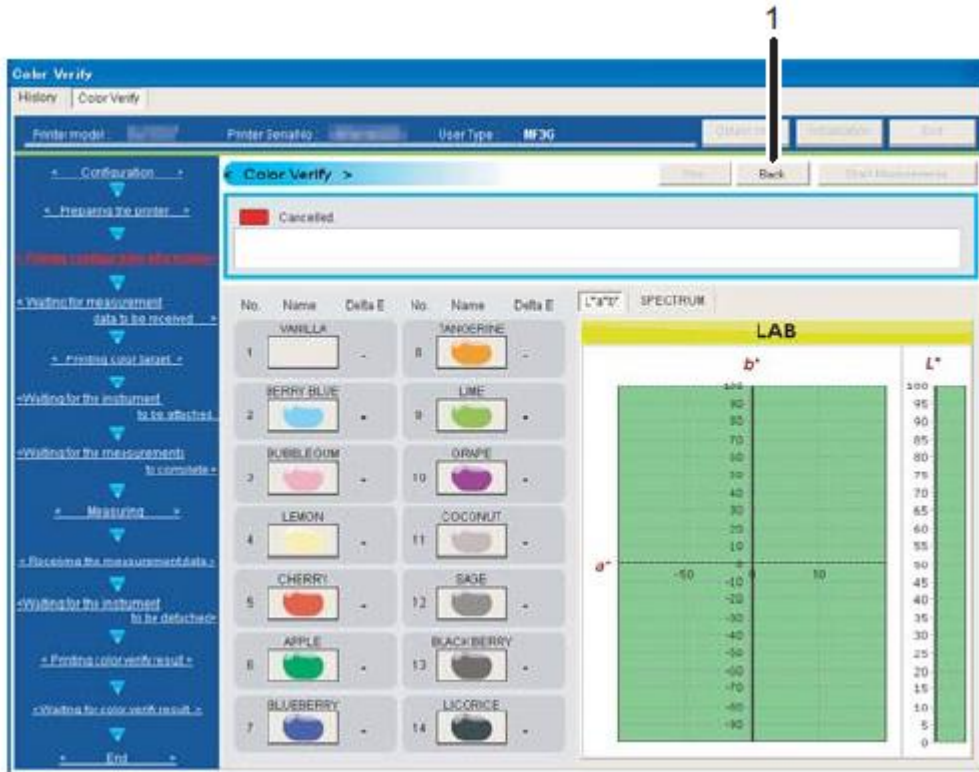

No.	Name	Description
1	Back	Return to the setup window.

10.2.15 Windows Firewall

Since the Windows "File Transfer Program (ftp.exe)" is used in the Color Verify function, deactivate the block when a firewall warning is displayed.

Patch data will not be printed until the block is deactivated.

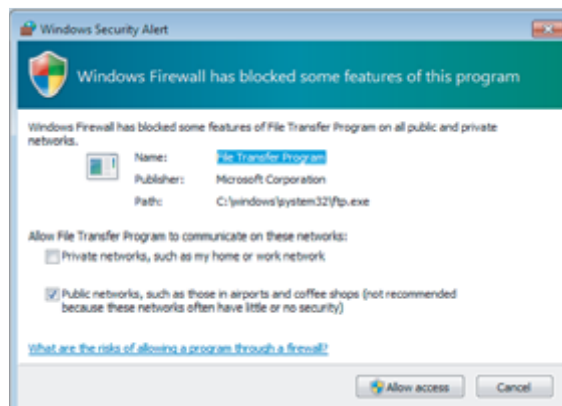

11. VSM Mobile

To use an application "VSM Mobile" for handheld terminal such as Smart Phone, the handheld terminal to be used form MSM should be registered, in order to obtain the printer information via MSM.



NOTE

- The application "VSM Mobile" for handheld terminal can be downloaded from Android market for free.
- Customer is responsible for the communication fee to connect to Android market.
- The communication between handheld terminal and MSM will require Wi-Fi connection.
- To communicate handheld terminal with MSM, a particular port will be used. If the setting of Windows firewall and security software needs to be changed, please check with your network administrator.

11.1. VSM Mobile Setting

The information of handheld terminal that uses the MSM Mobile can be checked, and the handheld terminal can be registered.

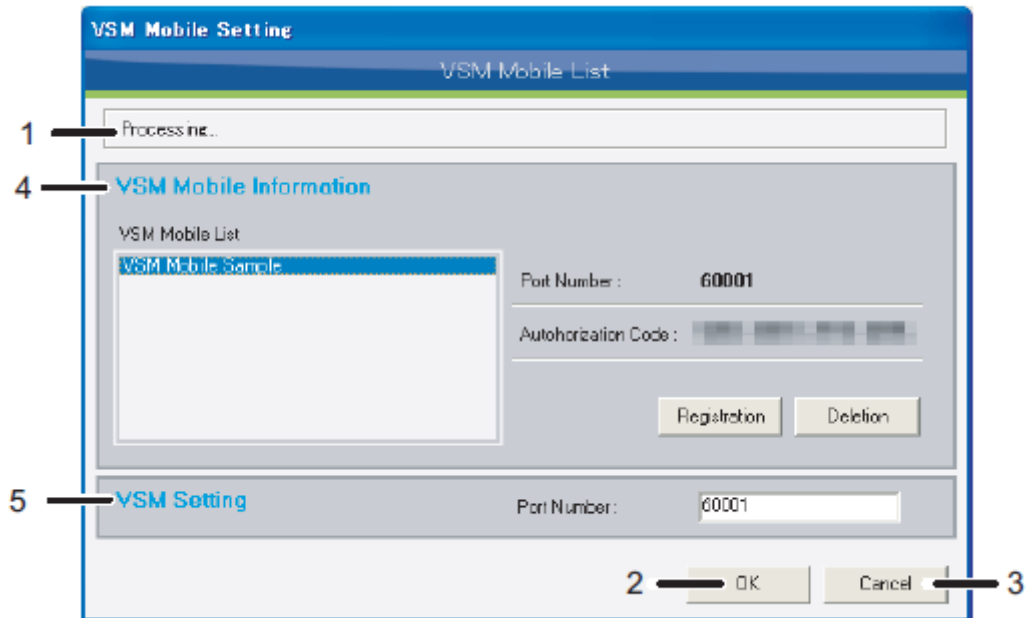

No.	Name	Description
1	Status	The connection status of VSM Mobile will be displayed.
2	OK	Save the registration information, and exit the VSM Mobile setting.
3	Cancel	Exit the VSM Mobile setting without saving the registration information.
4	VSM Mobile Information	The VSM Mobile can be checked. * For details, refer to "11.1.1 VSM Mobile Information"
5	MSM Setting	Configure the MSM setting needed to link with VSM Mobile. * For details, refer to "11.1.2 MSM Setting"

11.1.1 VSM Mobile Information

The information of VSM Mobile registered on MSM can be checked, and VSM Mobile can be registered / deleted.

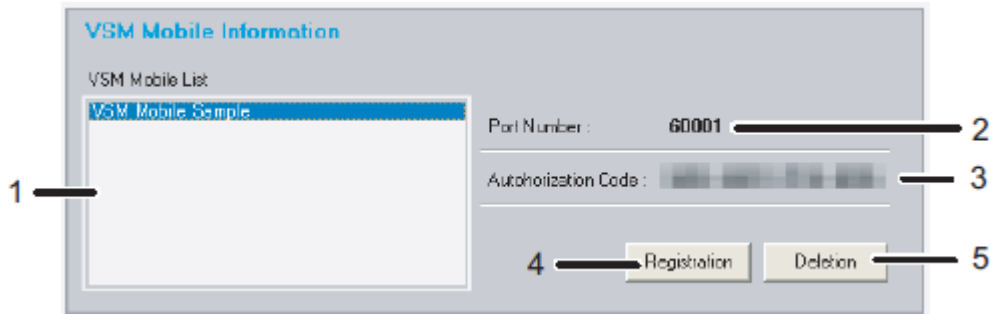

No.	Name	Description
1	VSM Mobile List	The VSM Mobile registered on MSM will be displayed.
2	Port Number	The connection port number registered at the VSM Mobile registration will be displayed.
3	Authorization Code	The authorization code registered at the VSM Mobile registration will be displayed.
4	Registration	Press "Registration" button to register new VSM Mobile. * For details, refer to "11.1.1.1 Registration"
5	Deletion	The registered VSM Mobile can be deleted. Select unnecessary VSM Mobile and delete from the list. * If the VSM Mobile is deleted, the communication with VSM Mobile will be disabled. To make a communication again, the registration will be needed again.

11.1.1.1. Registration

New VSM Mobile can be registered in MSM.

Follow the procedures below to register new VSM Mobile.

No.	Name	Target Application	Description
(1)	VSM Mobile Synchronization	MSM	MSM is waiting for the synchronization with VSM Mobile.
(2)	Entry / Registration of VSM Mobile Registration Information	VSM Mobile	Enter and register the VSM Mobile information based on the information displayed on MSM.
(3)	Registration of VSM Mobile	MSM	When MSM and VSM Mobile are synchronized normally, the VSM Mobile can be registered in MSM.

NOTE

- To register the VSM Mobile in MSM, download and install VSM Mobile to your handheld terminal from Android market.

(1) VSM Mobile Synchronization

When the "Registration" button is selected, a window to register the VSM Mobile will be displayed.

The MSM will be synchronization wait status, and wait for the connection from the VSM Mobile.

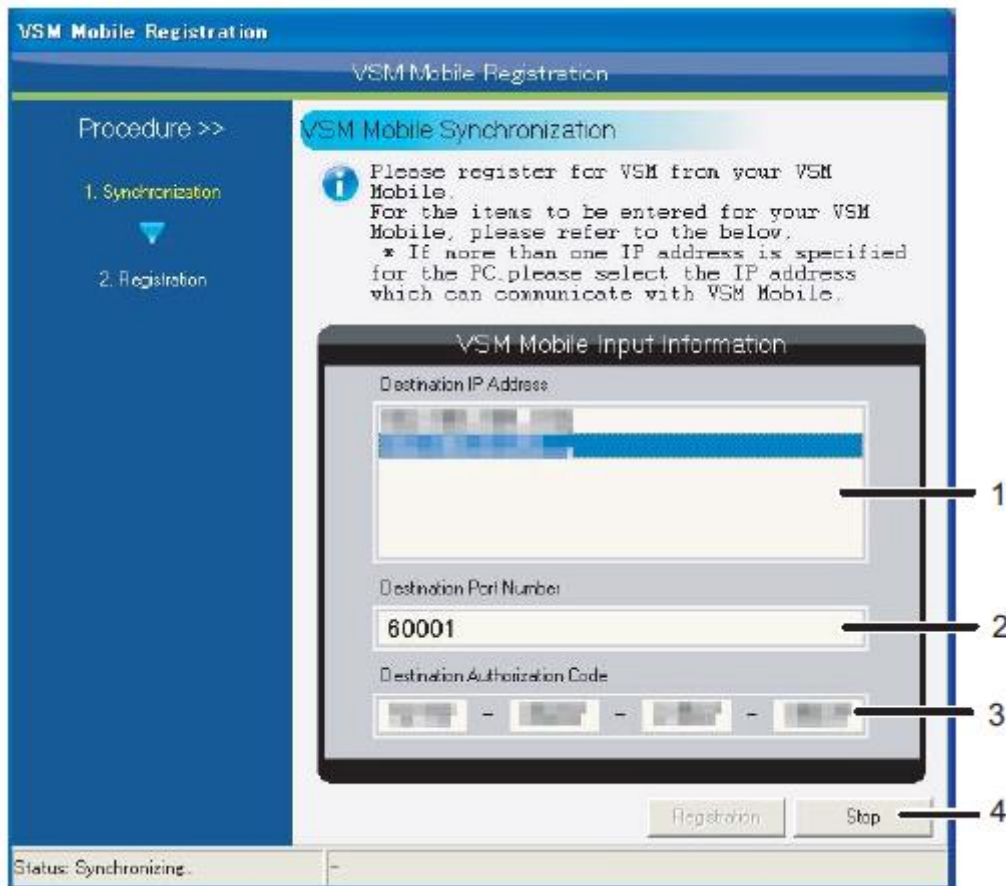

No.	Name	Description
1	Destination IP Address	The IP address list the PC installed with MSM will be displayed. * If several IP addresses are specified in the PC, select the IP address that can communicate with VSM Mobile.
2	Destination Port Number	The port number to be used for the connection of MSM and VSM Mobile will be displayed.
3	Destination Authorization Code	The authorization code will be displayed to identify the VSM Mobile.
4	Stop	The VSM Mobile registration will be stopped.

(2) Entry / Registration of VSM Mobile Registration Information

Register the MSM from VSM Mobile, and check the connection with MSM that is waiting for synchronization.

Enter the information based on the VSM Mobile entry information of the MSM.

MSM

VSM Mobile

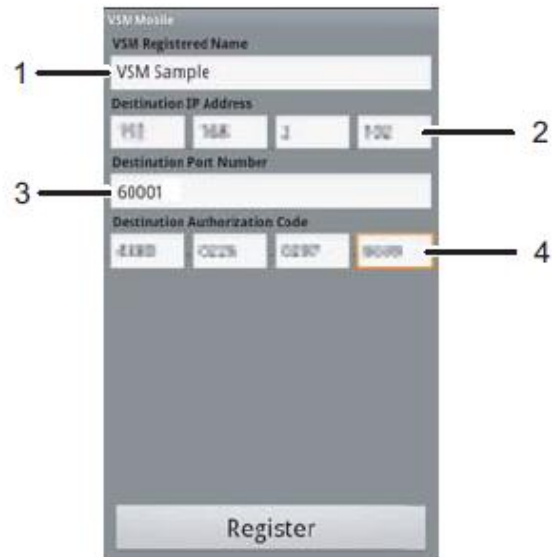
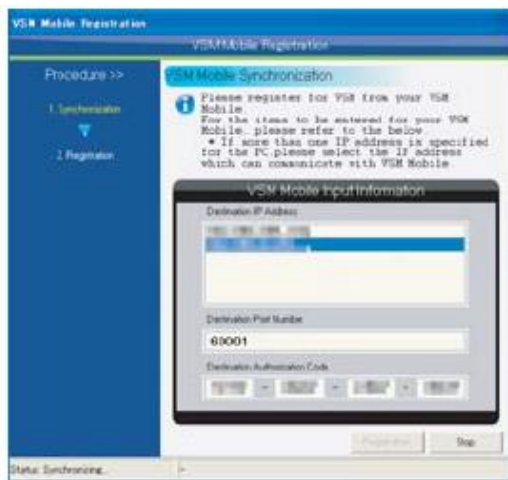

No.	Name	Description
1	Registered Name for MSM	Enter an arbitrary name of the MSM to register.
2	Destination IP Address	Enter the IP address of the PC installed with MSM. * If several IP addresses are specified in the PC, select the IP address that can communicate with VSM Mobile.
3	Destination Port Number	The port number to be used for the connection of MSM and VSM Mobile will be displayed.
4	Destination Authorization Code	The authorization code will be displayed to identify the VSM Mobile.

(3) Registration of VSM Mobile

When MSM and VSM Mobile are synchronized normally, the VSM Mobile can be registered in MSM.

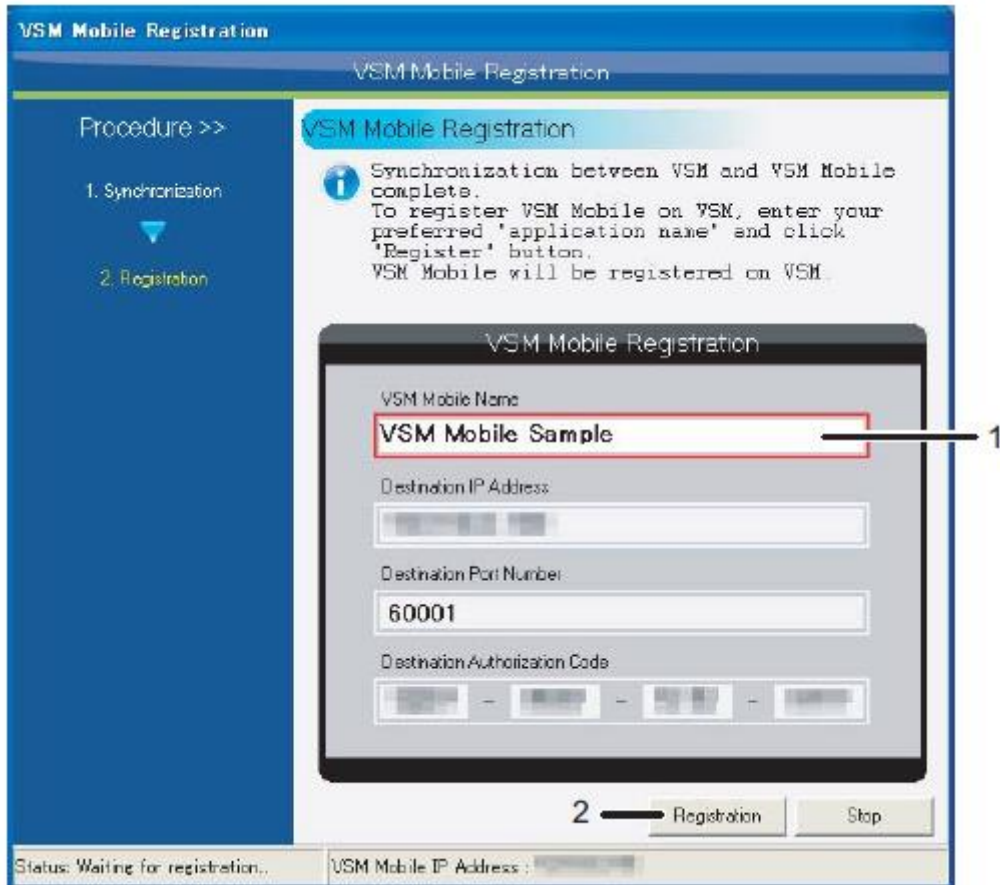

No.	Name	Description
1	VSM Mobile Name	Enter an arbitrary name of the VSM Mobile to register.
2	Registration	If there is no same name as entered name, the VSM Mobile can be registered.

11.1.2 MSM Setting

Set up the part to connect MSM with VSM Mobile.

The screenshot shows a grey rectangular box with the text "VSM Setting" in blue on the left. To the right, it says "Port Number :". Next to this is a white input field containing the number "60001". A black arrow points from the right side of the input field to a small black box containing the number "1".

No.	Name	Description
1	Port Number	Enter the port number to be used for the connection of MSM and VSM Mobile.

NOTE

- If the port number conflicts with other application, change the port number to an arbitrary number. To change the port number, please check with your network administrator.
- When the port number is changed, please change the port number of VSM Mobile that was registered before the change also.

12. Print History

This function allows MSM to get print history information from printer and monitor the history.

Main Function:

- *Access to the print history
- *Statistics Information
- *Cost Information

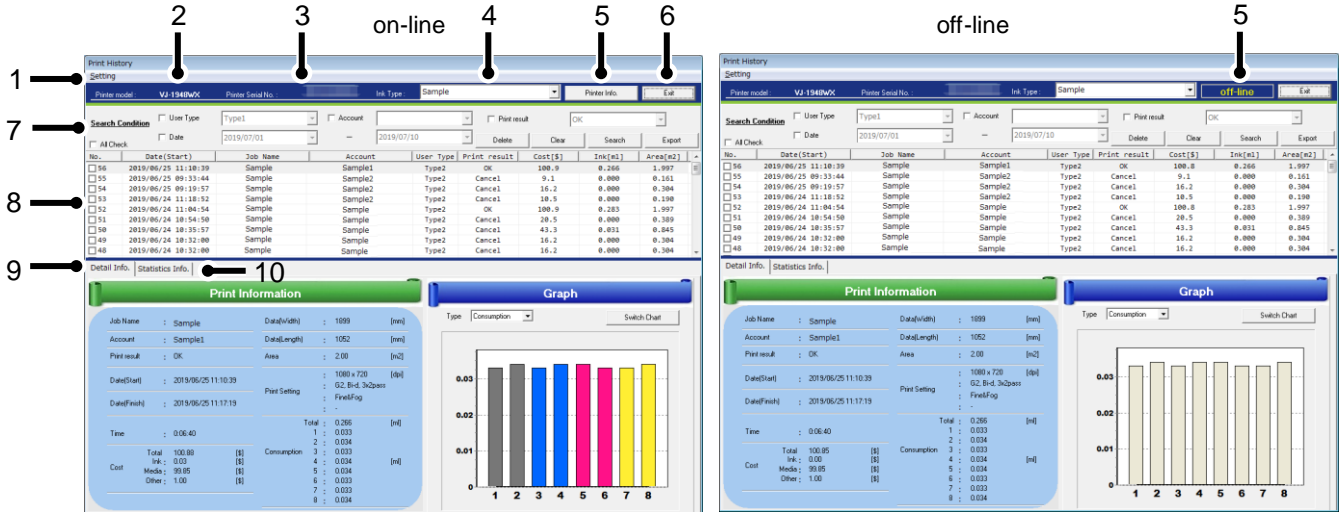

No.	Name	Description
1	Setting	Register the cost information or initialize print history. * For details, refer to "12.5 Setting"
2	Printer model	The selected printer model is displayed.
3	Printer Serial No.	The serial number of the selected printer is displayed.
4	Ink Type	Select the ink type from drop-down list registered in "Cost Setting" < "Ink".
5	Printer Information	Get the latest print history from the printer. This feature is available only when the printer is online.
6	Exit	Exit the Print History menu.
7	Search Condition	Set search condition for print history to be displayed in the list. * For details, refer to "12.1 Search Condition"
8	Print History List	Displays the search result of print history. * For details, refer to "12.2 Print History List"
9	Detail Information	Displays the detail information for the specified print history. * For details, refer to "12.3 Detail Information"
10	Statistics Information	Displays print history statistically. * For details, refer to "12.4 Statistics Information"

12.1. Search Condition

Refine search result of print history to be displayed.

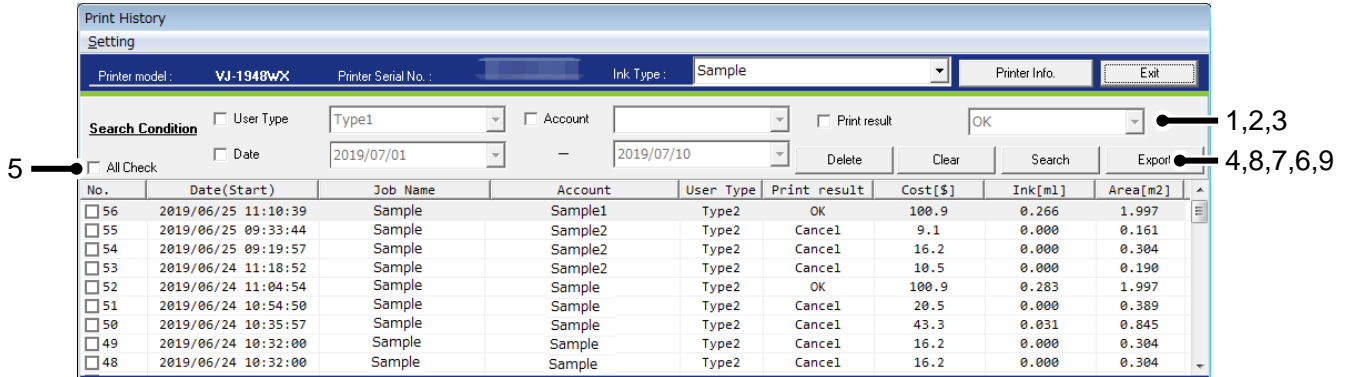

No.	Name	Description
1	User Type	Check the box and select the user type from the drop-down list.
2	Account	Check the box and select the account from the drop-down list.
3	Print result	Check the box and select print result from: OK : Successfully printed. Cancel : Failed to finish printing.
4	Date	Check the box and specify the time period of printing from the drop-down list.
5	All Check	Check the box to select all print history to be deleted.
6	Search	Display the result to be matched criteria specified.
7	Clear	Clear the search condition and display all print history.
8	Delete	Delete the print history you selected. If you delete the history, you cannot recover the data.
9	Export	Save a list of print history with .csv extension. * For details, refer to "12.8 Export"

12.2. Print History List

Displays the list of print history extracted from the printer.

No.	Date(Start)	Job Name	Account	User Type	Print result	Cost[\$]	Ink[mL]	Area[m2]
<input type="checkbox"/> 10	2018/06/19 14:51:56	Sample	Sample1	Type2	OK	10.2	0.232	0.002
<input type="checkbox"/> 9	2018/06/19 14:41:52	Sample	Sample2	Type2	OK	10.3	0.202	0.004
<input type="checkbox"/> 8	2018/06/19 14:36:26	Sample	Sample2	Type2	OK	10.3	0.127	0.003
<input type="checkbox"/> 7	2018/06/19 14:28:12	Sample	Sample	Type2	OK	10.4	0.255	0.004
<input type="checkbox"/> 6	2018/06/19 14:20:35	Sample	Sample	Type2	OK	10.5	0.584	0.004
<input type="checkbox"/> 5	2018/06/19 14:08:27	Sample	Sample	Type2	OK	10.5	0.517	0.004
<input type="checkbox"/> 4	2018/06/19 15:39:45	Sample	Sample	Type2	OK	10.3	0.415	0.002
<input type="checkbox"/> 3	2018/06/19 15:31:51	Sample	Sample	Type2	OK	10.2	0.231	0.002
<input type="checkbox"/> 2	2018/06/19 15:25:03	Sample	Sample	Type2	OK	10.1	0.125	0.001

No.	Name	Description
1	No.	Displays the order of data in the list.
2	Daate(Start)	Displays print starting date and time.
3	Job Name	Displays job name. If the data does not contain its job name, it will not be displayed.
4	Account	Displays account. If the data does not contain account information, it will not be displayed.
5	User Type	Displays user type.
6	Print result	Displays print result from: OK : Successfully printed. Cancel : Failed to finish printing.
7	Cost	Displays expenses incurred in printings, if the cost information is registered.
8	Ink *1	Displays the ink consumption amount.
9	Area	Displays the area of printing.

NOTE

- *1 Ink consumption may vary depending on the print mode setting or other printing conditions even if printing the same image.

12.3. Detail Information

Displays detail information for the specified print history in data and graph format.

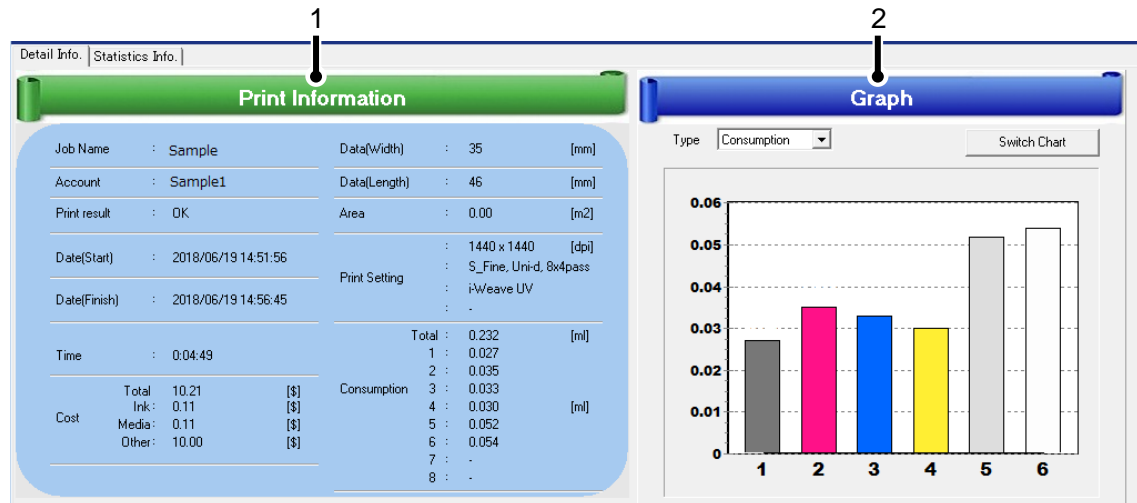

No.	Name	Description
1	Print Information	Displays the detail information for the specified print history.
2	Graph	Displays either of detail information in graph form: 1. Consumption 2. Cost

12.3.1 Print Information

Displays detail information for the specified print history.

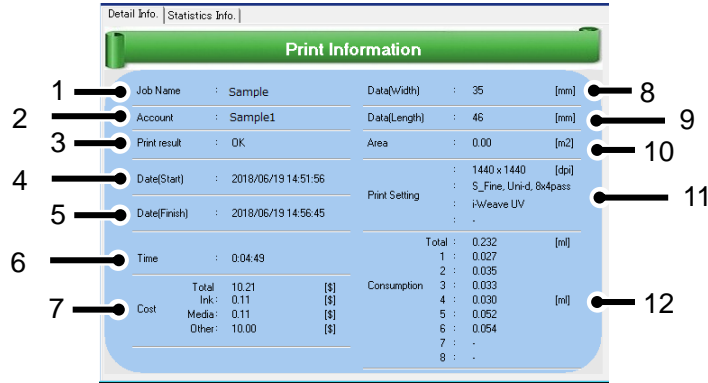

No.	Name	Description
1	Job Name	Displays the job name. If the data does not contain the job name, it will not be displayed.
2	Account	Displays the account. If the data does not contain the account information, it will not be displayed.
3	Print result	Displays the print result from: OK : Successfully printed. Cancel : Failed to finish printing.
4	Date(Start)	Displays the print starting date and time.
5	Date(Finish)	Displays the print completion date and time.
6	Time	Displays the total printing time.
7	Cost	Displays the expense incurred in the printing, if the cost information for the print job is registered.
8	Data(Width)	Displays the width of printing.
9	Data(Length)	Displays the length of printing.
10	Area	Displays the area of printing.
11	Print Setting	Displays the print setting below. 1. Printing Resolution 2. Print Quality 3. Direction 4. Pass 5. Effect
12	Consumption *1	Displays the ink consumption amount.

NOTE

- *1 Ink consumption may vary depending on the print mode setting or other printing conditions even if printing the same image.

12.3.2 Graph

Display print information in two types of graph form.

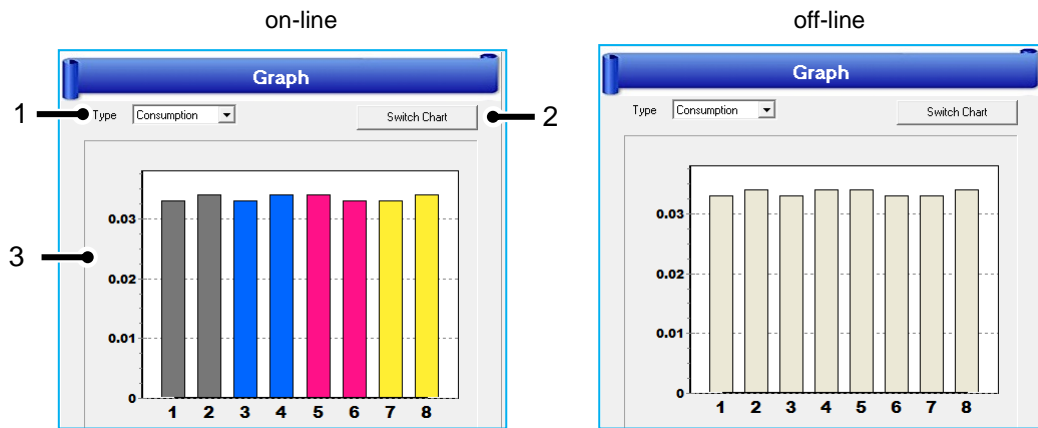

No.	Name	Description
1	Type	Choose the information type to be displayed in graph form from: 1. Consumption 2. Cost
2	Switch Chart	Switch the chart type from: 1. Bar Chart 2. Pie Chart
3	Graph	Displays the specified information in graph form.

NOTE

*1 If the printer is offline, MSM is unable to obtain the ink color information from the printer. In such cases, the chart will be displayed with random colors chosen by default.

12.4. Statistics Information

Displays print history statistically in data and graph format.

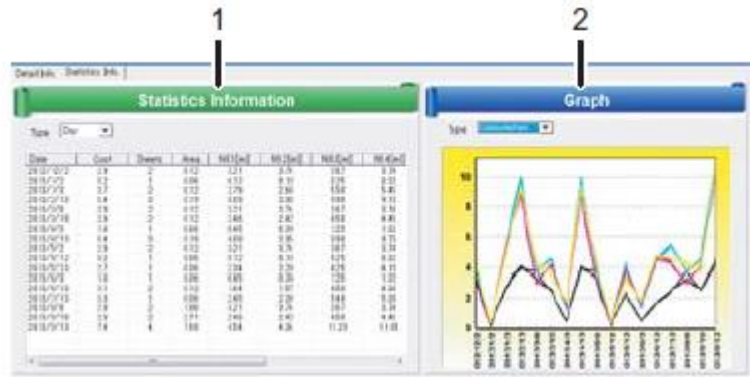

No.	Name	Description
1	Statistics Information	Displays print history statistically.
2	Graph	Displays the statistics information from below in graph form: 1. Cost 2. Sheets 3. Area 4. Consumption

12.4.1 Statistics Information

Display statistics print history information by specified time period.



No.	Name	Description
1	Type	Choose the time period to be displayed from: 1. Day 2. Month 3. Year
2	Date	Displays the specified time period. e.g.) 1. In case of Month, it displays YYYY/MM.=>2013/9, 2013/8 2. In case of Day, it displays YYYY/MM/DD.=>2013/9/12, 2013/9/10, 2013/9/08
3	Cost	Displays expenses incurred in printings.
4	Sheets	Displays the number of printed sheets.
5	Area	Displays the total area of printings.
6	Consumption	Displays the ink consumption amount per slot.

12.4.2 Graph

Display statistic information from Cost/ Sheets/ Area/ Consumption in graph form.

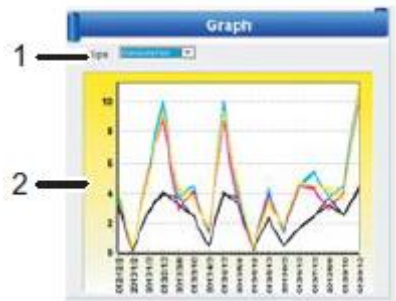

No.	Name	Description
1	Type	Choose the information type for the graph from: 1. Cost 2. Sheets 3. Area 4. Consumption
2	Graph	Displays the specified information in graph form.

12.5. Setting

This menu registers cost information or initializes print history.

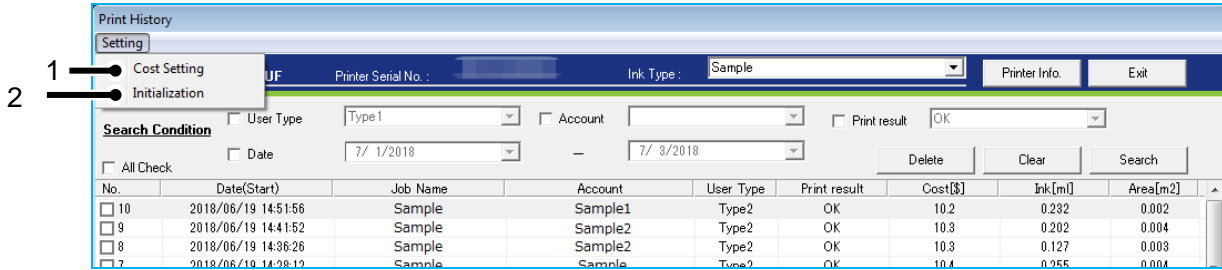

No.	Name	Description
1	Cost Setting	Register cost information to be spent for the printing. * For details, refer to "12.6 Cost Setting"
2	Initialization	Initialize print history. * For details, refer to "12.7 Initialization"

12.6. Cost Setting

To calculate cost per print, registers cost information to be spent for printings.



No.	Name	Description
1	Ink	Register ink cost information.
2	Media	Register media cost information.
3	Other	Register other expenses for printings.

NOTE

- Since the cost calculated here will be approximate cost, use this calculation as a guide.

12.6.1 Ink

Register unit price for each ink.

Ink cost per print can be calculated based on the ink consumption amount and registered unit price.

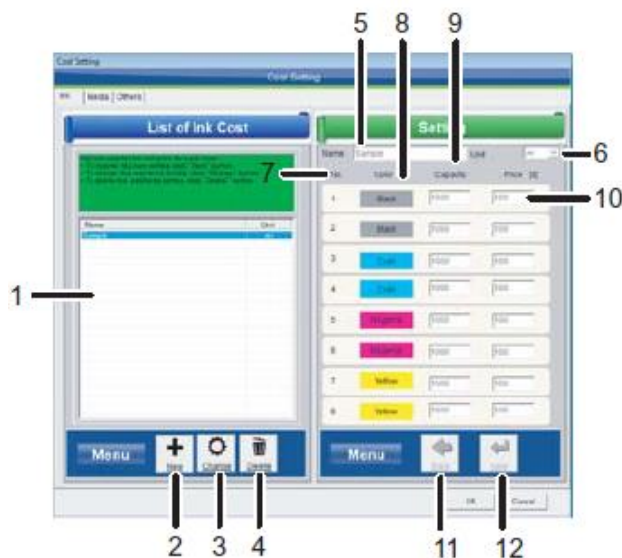

No.	Name	Description
1	Ink cost list	Displays the list of registered ink cost.
2	New button	Register a new ink setting.
3	Change button	Change the current settings.
4	Delete button	Delete the registered settings.
5	Name	Enter the ink name to register. *Enter up to 40 characters. *Cannot be saved with the same name.
6	Unit	Select ink capacity unit from: *Eml / Ecc
7	No.	Displays ink slot numbers in your printer.
8	Color	Displays ink color set in your printer. *Order of ink color to be displayed varies depending on your ink setting. *MSM is unable to obtain the ink color information if the printer is offline. In such cases, "Custom Color" will be displayed in this filed.
9	Capacity	Enter the ink capacity.
10	Price	Enter the ink unit price.
11	Back button	Return to the "Ink Cost List" menu.
12	Save button	Save the setting.

12.6.2 Media

Register unit price for each media.

Media cost per print can be calculated based on the area of printings.

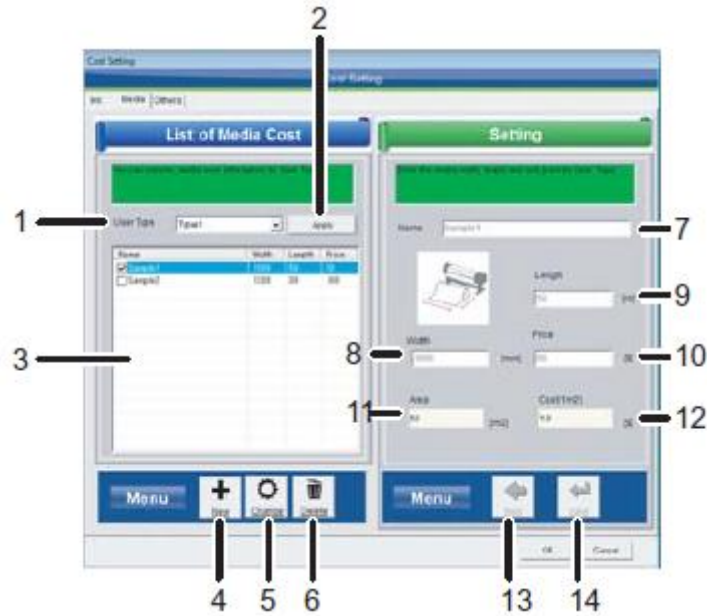

No.	Name	Description
1	User Type	Select user type. To apply registered media cost, check the box of cost information from the list. *Select one cost information at a time.
2	Apply button	Apply the checked media cost information to the specified user type.
3	Registered media list	Displays the list of registered media cost.
4	New button	Register a new media setting.
5	Change button	Change the current settings.
6	Delete button	Delete the registered settings.
7	Name	Enter the media name to register. *Enter up to 40 characters. *Cannot be saved with the same name.
8	Width	Enter the width of media. Unit: mm
9	Length	Enter the length of media. Unit: m
10	Price	Enter the media unit price.
11	Area	Displays the area of media calculated from the media size you entered.
12	Cost	Displays cost per square meter calculated from the unit price.
13	Back button	Return to the "Media Cost List" menu.
14	Save button	Save the setting.

12.6.3 Other

Register other expense incurred in printing.

Other cost per print can be calculated based on the cost information registered here.



No.	Name	Description
1	Other cost list	Displays the list of registered other cost. To apply the cost to cost calculation, check the box of cost information. *Multiple selections are acceptable.
2	Currency setting	Set the currency unit (Optional field).
3	Apply button	Apply the checked other cost information.
4	New button	Register a new cost setting.
5	Change button	Change the current settings.
6	Delete button	Delete the registered settings.
7	Name	Enter the name of cost information to register. *Enter up to 40 characters. *Cannot be saved with the same name.
8	Price	Enter the cost.
9	Unit(Type)	Select the unit type for the cost from: - Sheet (number of sheets) - m2 (area) - m (length) The cost will be calculated by the selected unit type.
10	Unit(Per)	Enter a unit of quantity for the unit type. The cost will be calculated by the specified unit of quantity.
11	Note	Add notes (Optional).
12	Back button	Return to the "Other Cost List" menu.
13	Save button	Save the setting.

12.7. Initialization

Initialize print history. Once initialized, all the print history and registered cost information will be deleted.

12.8. Export

Save the listed print history to a csv file. There are two ways to save.

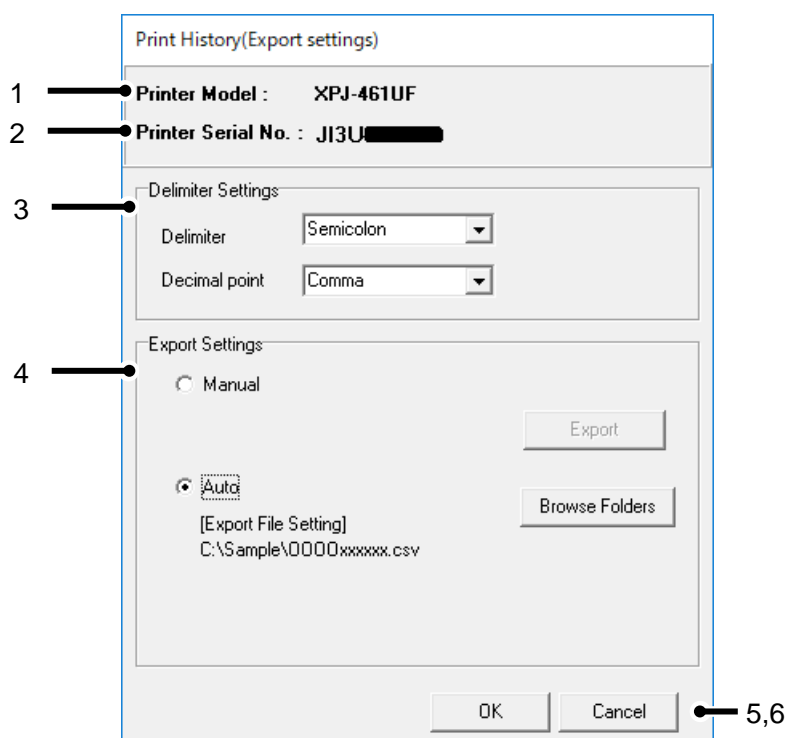

No.	Name	Description
1	Printer model	Displays the selected printer model.
2	Printer Serial No.	Displays the printer serial number.
3	Delimiter Settings *1	Select the setting for each delimiter. Delimiter : Tab / Semicolon / <Comma> Decimal point : Comma / <Period>
4	Export Settings	Select the export type. Manual / Auto
5	OK	Select to export your settings.
6	Cancel	Select to cancel the setting.

NOTE

- *1 Decimal point is fixed to "period" if delimiter is "comma".

12.8.1 Manual

Specify the export destination and export manually.

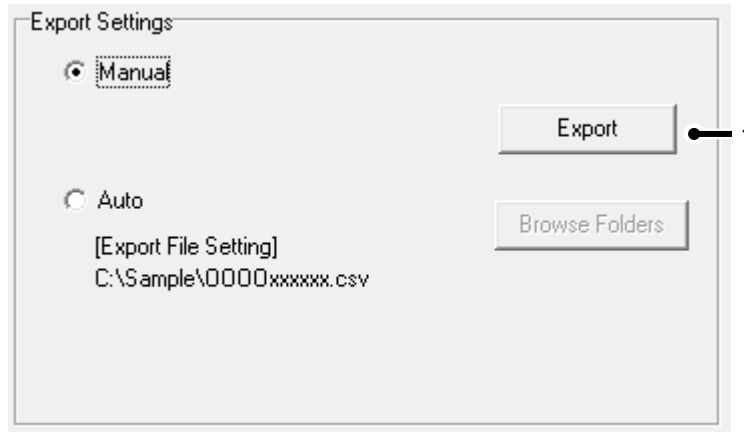

No.	Name	Description
1	Export	Specify the export destination and export manually.

12.8.2 Auto

Specify the export destination in advance and export it automatically when the printer information is acquired.

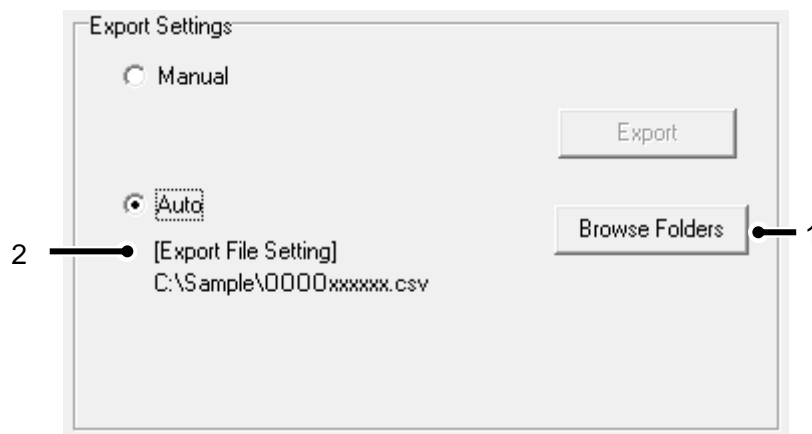

No.	Name	Description
1	Browse Folders	Specify the export destination.
2	Export File Setting	Displays the set export destination.

13. Remote Panel



This function allows you to check the current panel setting in your printer and perform test pattern printing. The available function varies depending on the printer you use.

13.1. VJ-628/628X/628MP

13.1.1 Remote Panel

Check the printer information and the remote panel status.



No.	Name	Description
1	Printer model	The selected printer model is displayed.
2	Printer Serial No.	The serial number of selected printer is displayed.
3	Status	The remote panel status is displayed.
4	Remote Panel Mode(Status)	Displays current remote panel mode from:  Remote Panel Mode On  Remote Panel Mode Off
5	Remote Panel Mode Button	Enable/Disable remote panel mode.
6	Update	Change the printer settings.
7	Printer Information button	Get current panel setting information from your printer. *Printer information of the selected tab is obtained.
8	Exit button	Exit the Remote Panel menu.

13.1.2 Printer Status

Displays the printer status and remotely operate the printer.



No.	Name	Description
1	Status Information	The current printer status is displayed. If the printer encounters a system error, a workaround will be displayed.
2	Heater Information	Check and change the heater temperature. * The Heater Set temperature is reflected from: Media Setting tab > Media Type > Media Setting > Heater. When the printer is warming up, you can cancel the warm-up and start printing.
3	Ink Information	The remaining ink amount of the printer is displayed. For the details of S/C card recovery, see 7.7.2 S/C Card Recovery.
4	Printer Control	Remotely perform the following operations: •Print Cancel •Media Cut •Nozzle Check
5	Sleep Mode	Remotely switch the printer to Sleep Mode.
6	Waste Ink	The amount in the waste ink tank is displayed. The waste ink counter can be reset.
7	Auto Printer Information	Check this box to automatically get printer information. On : Enable Off : Disable *This function is not available when MSM is launched from the Windows printer driver.
8	Interval	When "Auto Printer Information" is ON, set a time interval to get the latest information from the printer. Value can be set from: <60[sec]> / 30[sec] / 10[sec] / 3[sec]
9	Status Only	Check this box to obtain the printer status information only to minimize the data acquisition time. *This check box is enabled when "Auto Printer Information" is set to ON.

13.1.2.1. Heater Information

Check and change the heater temperature.



No.	Name	Description
1	Heater : Heater Set	Check and change the heater temperature for the media.
2	Heater : Temperature	The actual temperature of each heater will be displayed.
3	Blower : Auto Off *1	Set the auto power-off to the blower heater. Setting : On / <Off>
4	Warm-Up Cancel	When the printer is warming up, you can cancel the warm-up and start printing.

NOTE

- *1 This function is available for VJ-628MP.

13.1.2.2. Sleep Mode

Remotely switch the printer to Sleep Mode.



No.	Name	Description
1	Enter *2	Enter/Wake up from Sleep Mode.
2	Cleaning Timer *3	Set the cleaning timer during Sleep Mode. Setting : VJ-628: < Off > / 1 / 2 / 3 / 4 / 5 / 6 / 9 / 12 / 18 / 24 [h] VJ-628X: Off / 1 / 2 / 3 / 4 / 5 / 6 / 9 / 12 / 18 / < 24 [h] >
3	Auto Timer *1,3	Set the timer to automatically enter to Sleep Mode while in Standby Mode. Setting : 1 / 2 / < 3 > / 4 / 5 / 6 [h]

<> Default setting

NOTE

- *1 The Auto Timer setting is enabled when the ink set of VJ-628X contains white ink.
- *2 In VJ-628MP, daily maintenance is required before entering to Sleep Mode. By pressing [Enter], the Daily Maintenance wizard appears.
- *3 The Cleaning Timer setting is not available for VJ-628MP.

13.1.2.3. Clear printer status

A particular printer status can be cleared.

Follow the instructions on the message box to clear the status.

[Status that can be cleared]

Check ink expiration date

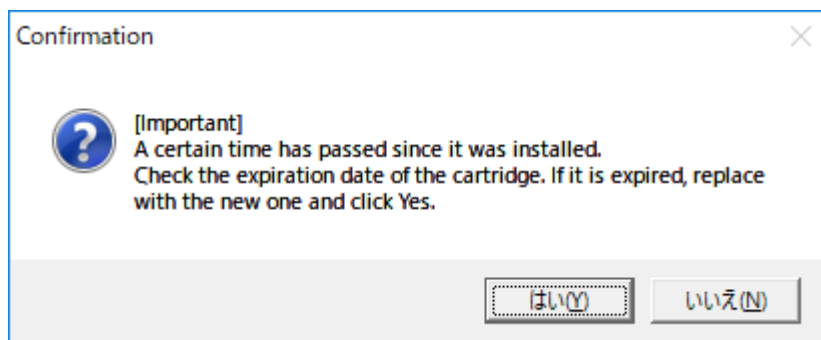

Check ink color (Smart Chip Recovery)

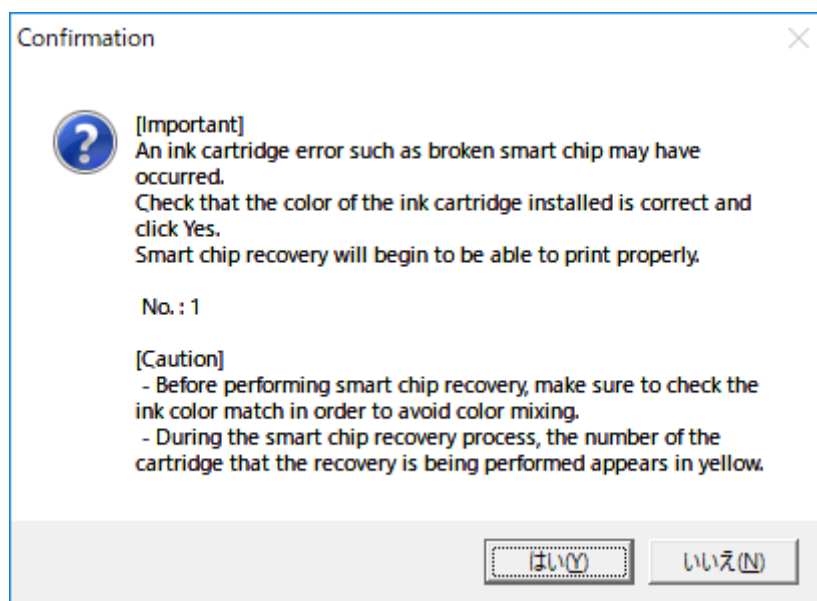

NOTE

- If the previous version of F/W is installed, the settings may not be properly reflected. Make sure to install the latest F/W.
- Read the message displayed and clear the status.

13.1.3 Printer Control

Remotely operate the printer.

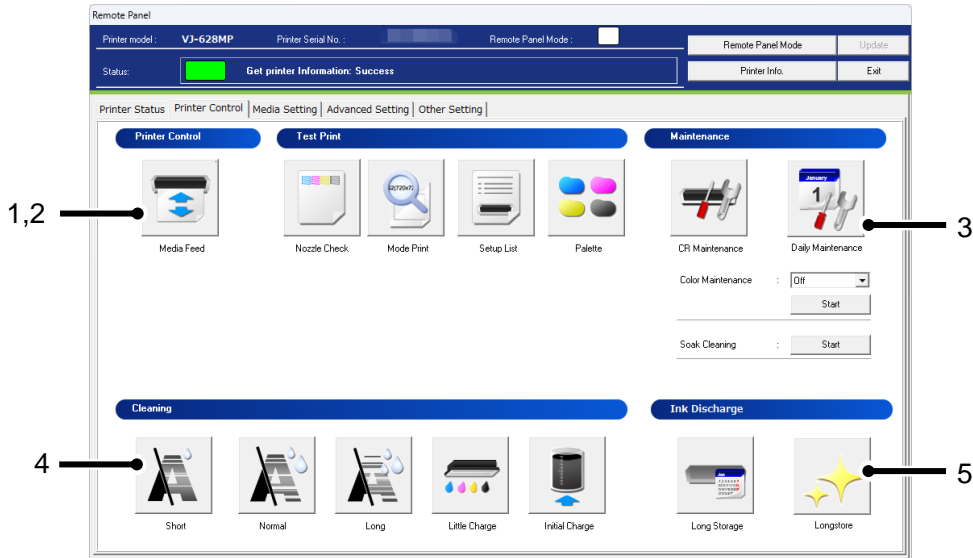

No.	Name	Description
1	Printer Control	Remotely operate the printer.
2	Test Print	Perform the test print selected from this menu.
3	Maintenance	Perform the maintenance selected from this menu.
4	Cleaning	Perform the cleaning selected from this menu.
5	Ink Discharge	Perform the ink discharge selected from this menu.

13.1.3.1. Printer Control

Remotely operate the printer.

(1) Media Feed

Specify the feeding amount of media set in the printer and feed it in forward/ backward with the specified amount.

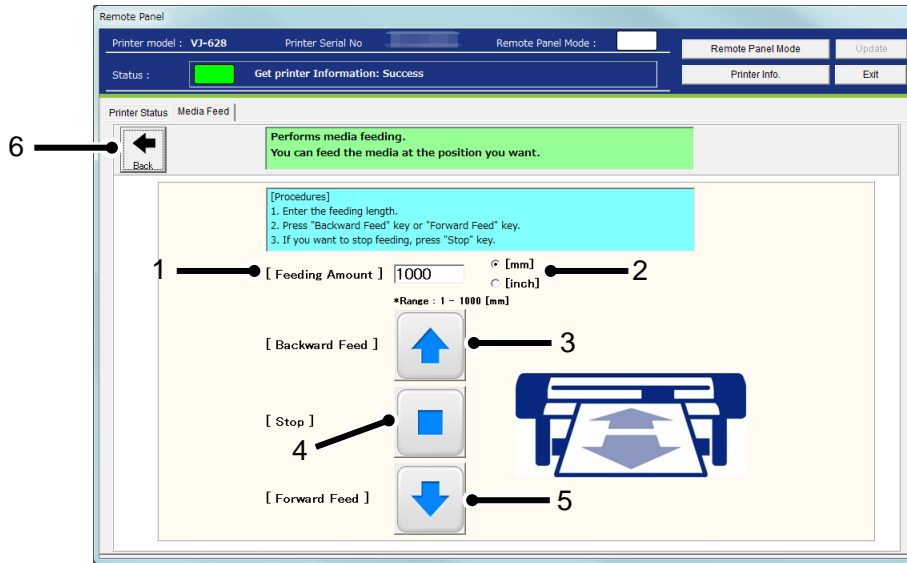

No.	Name	Description
1	Feeding Amount	Specify the media feeding amount range between: · In [mm] setting: 1 ~ < 1000 mm > (in increments of 1 mm) · In [inch] setting: 0.04 ~ < 39.37 inch > (in increments of 0.01 inch)
	Unit of Feeding Amount	Select the unit of feeding amount from: <mm> or inch
3	Backward Feed	Feed the media backward with the specified amount.
4	Stop	Stop the media feeding.
5	Forward Feed	Feed the media forward with the specified amount.
6	Back	Go back to the Printer Control Main Menu.

<> Default setting

NOTE

- The printer will feed the media according to the setting you specified. Make sure to specify the appropriate amount to prevent unwinding.

13.1.3.2. Test Print

Perform the test print selected from the menu.

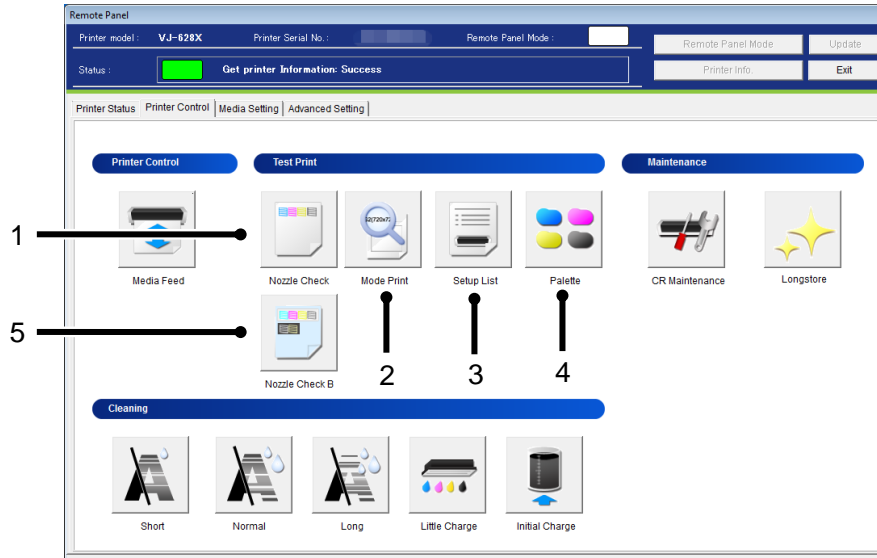

No.	Name	Description
1	Nozzle Check	Print the nozzle check pattern.
2	Mode Print	Print the printing conditions.
3	Setup List	Print the current printer setup list.
4	Palette	Print the palette pattern. *In some print modes, this menu is not available.
5	Nozzle Check B *1	Print the nozzle check B pattern.

NOTE

- *1 The nozzle check B pattern is available when the ink set of VJ-628X/628MP contains white ink.

13.1.3.3. Maintenance

Remotely perform printer maintenances.

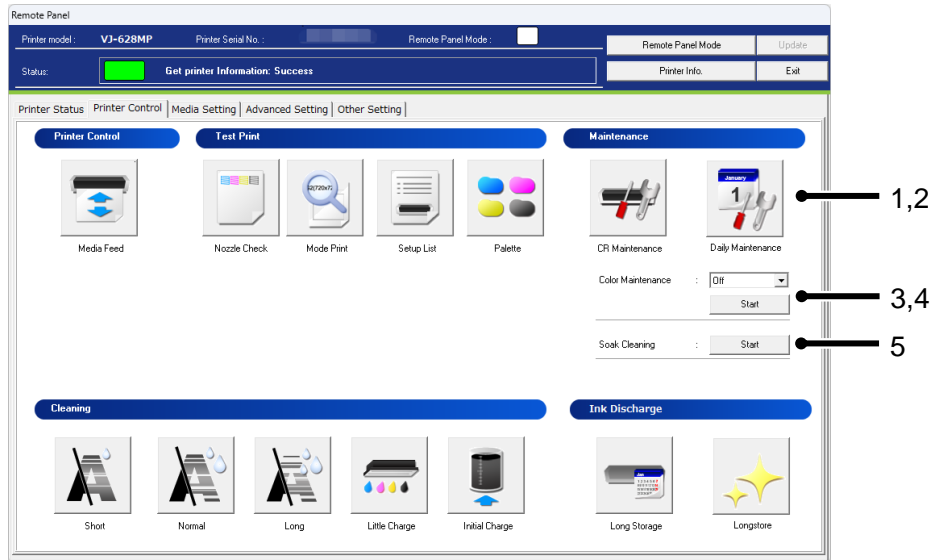

No.	Name	Description
1	CR Maintenance	Remotely perform CR Maintenances.
2	Daily Maintenance *1	Remotely perform Daily Maintenances.
3	Color Maintenance *1	Set the color maintenance. Setting : On / < Off >
4	Color Maintenance Start *1	Perform color maintenance.
5	Soak Cleaning *1	Perform soak cleaning.

NOTE

- *1 This function is available for VJ-628MP.

(1)CR Maintenance

1) VJ-628 / 628X

1-1) Check Printer Status

Before performing CR maintenance, check the printer status.

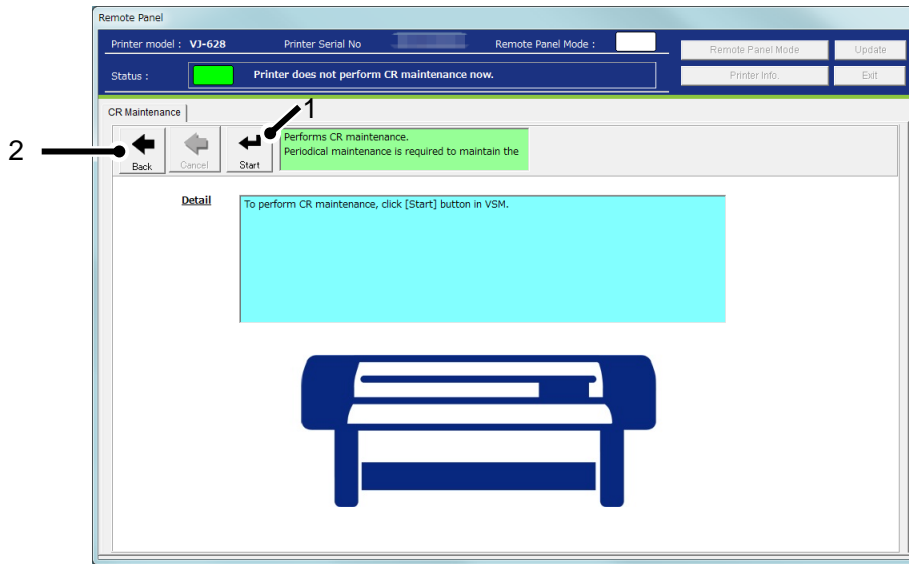

No.	Name	Description
1	Start	Instruct the printer to perform CR Maintenance.
2	Back	Go back to the Printer Control Main Menu.

Maintenance is being performed in the printer.

After maintenance is completed, press Operation key on the printer panel.

1-2) Waiting to press [Operation] button in printer.

Before performing CR maintenance, press Operation key on the printer panel and then start CR maintenance.

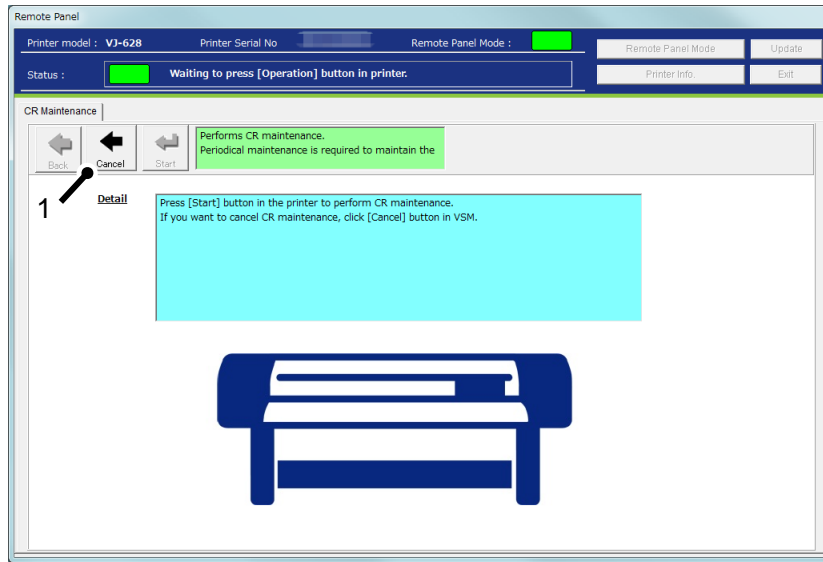

No.	Name	Description
1	Cancel	Cancel to perform CR maintenance.

NOTE

- Before starting CR maintenance, make sure to press Operation key on the printer panel.

1-3) Performing CR maintenance

CR maintenance is being performed in the printer.

After CR maintenance is completed, press Operation key on the printer panel.

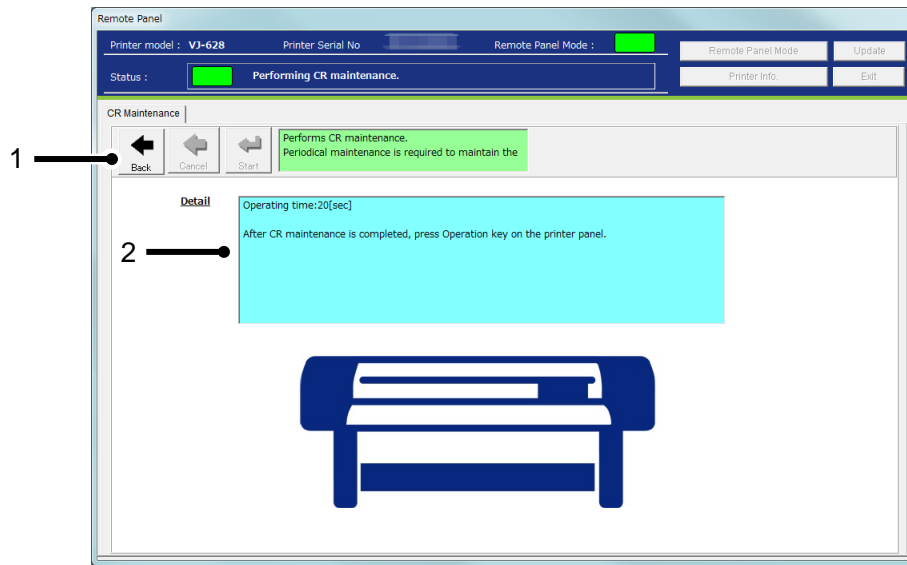

No.	Name	Description
1	Back	Go back to the Printer Control Main Menu.
2	Detail	CR maintenance elapsed time is displayed.

NOTE

- After CR maintenance is completed, make sure to press Operation key on the printer panel.

2) VJ-628MP

2-1) Check Printer Status

Before performing CR maintenance, check the printer status.

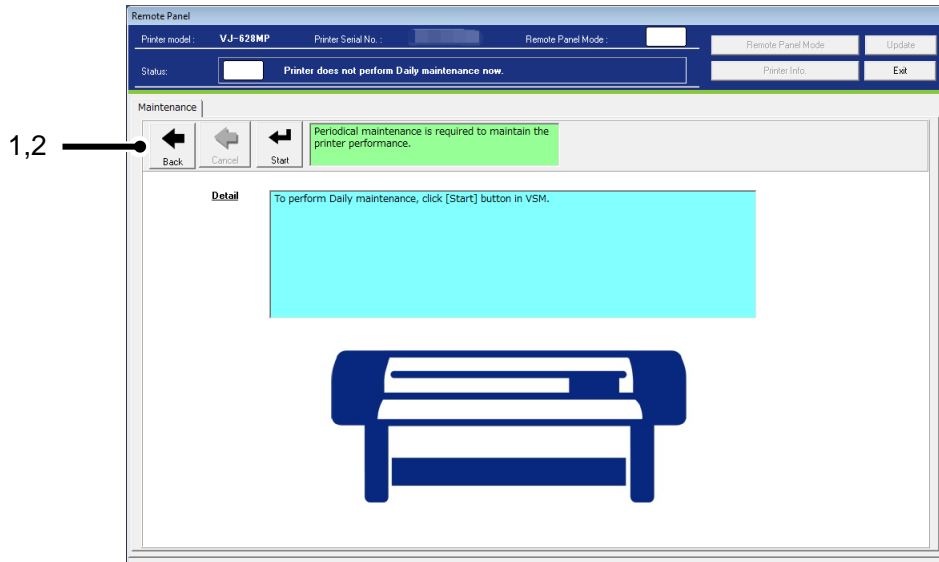

No.	Name	Description
1	Start	Instruct the printer to perform CR Maintenance.
2	Back	Go back to the Printer Control Main Menu.

Maintenance is being performed in the printer.

After maintenance is completed, press Operation key on the printer panel.

2-2) Waiting to press [Operation] button in printer.

Before performing CR maintenance, press Operation key on the printer panel and then start CR maintenance.

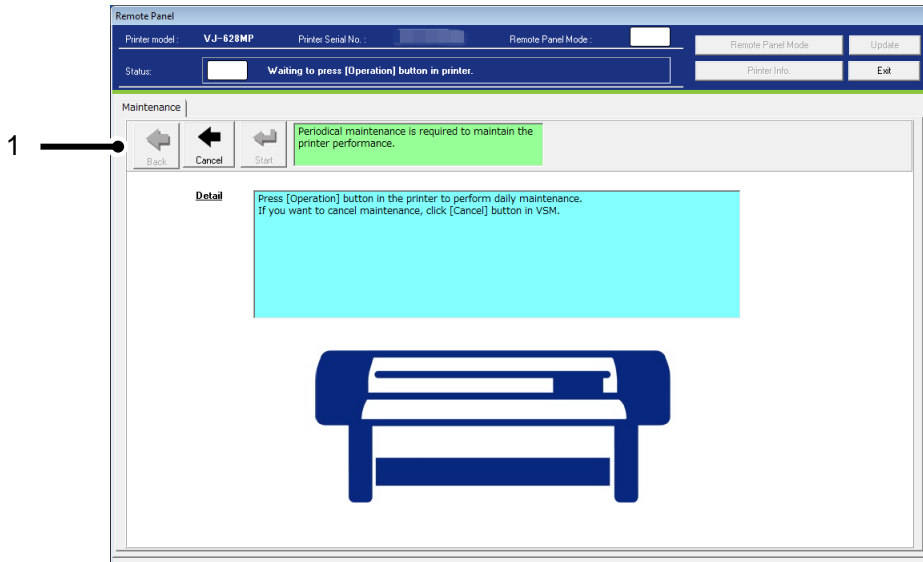

No.	Name	Description
1	Cancel	Cancel to perform CR maintenance.

NOTE

- Before starting CR maintenance, make sure to press Operation key on the printer panel.

2-3) Performing CR maintenance

Maintenance is being performed in the printer.

After maintenance is completed, press Operation key on the printer panel.

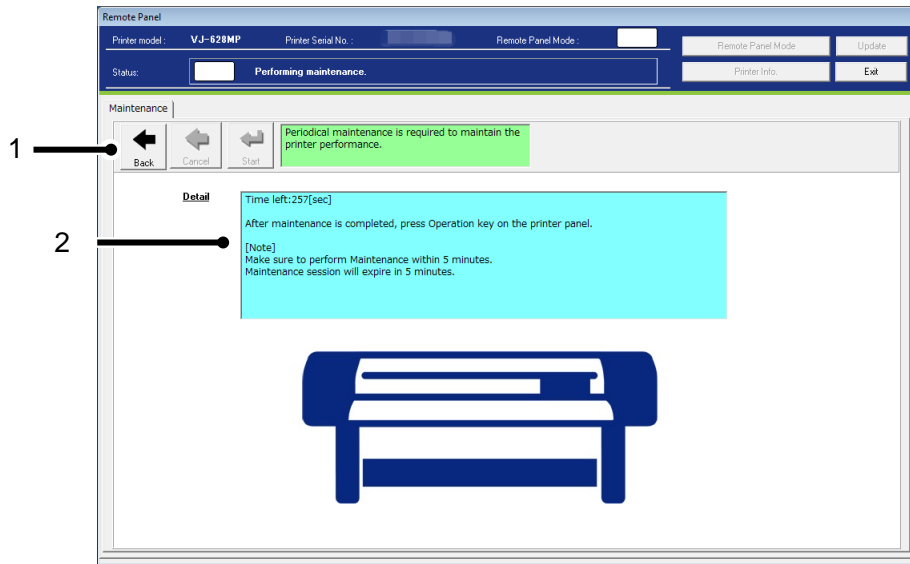

No.	Name	Description
1	Back	Go back to the Printer Control Main Menu.
2	Detail	CR maintenance elapsed time is displayed.

NOTE

- After CR maintenance is completed, make sure to press Operation key on the printer panel.
- Since your session will expire in 5 minutes, perform CR maintenance within 5 minutes.
If your session has expired, finish CR maintenance.

(2) Daily Maintenance

1) Check Printer Status

Before performing Daily maintenance, check the printer status.

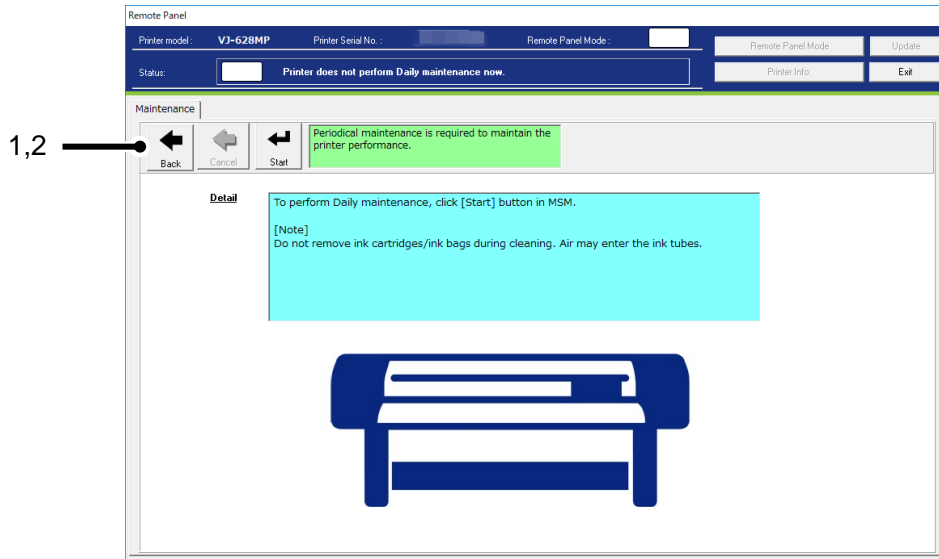

No.	Name	Description
1	Start	Instruct the printer to perform Daily Maintenance.
2	Back	Go back to the Printer Control Main Menu.

Maintenance is being performed in the printer.

After maintenance is completed, press Operation key on the printer panel.

2) Waiting to press [Operation] button in printer.

Before performing Daily maintenance, press Operation key on the printer panel and then start Daily maintenance.

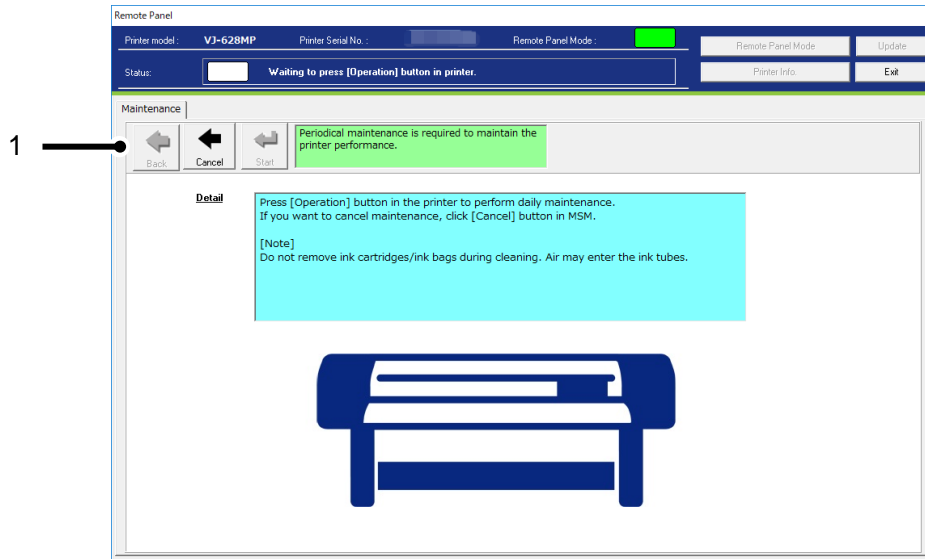

No.	Name	Description
1	Cancel	Cancel to perform Daily maintenance.

NOTE

- Before starting daily maintenance, make sure to press Operation key on the printer panel.

3) Cleaning

The printer performs head cleaning before daily maintenance.

Please wait until the cleaning is complete.

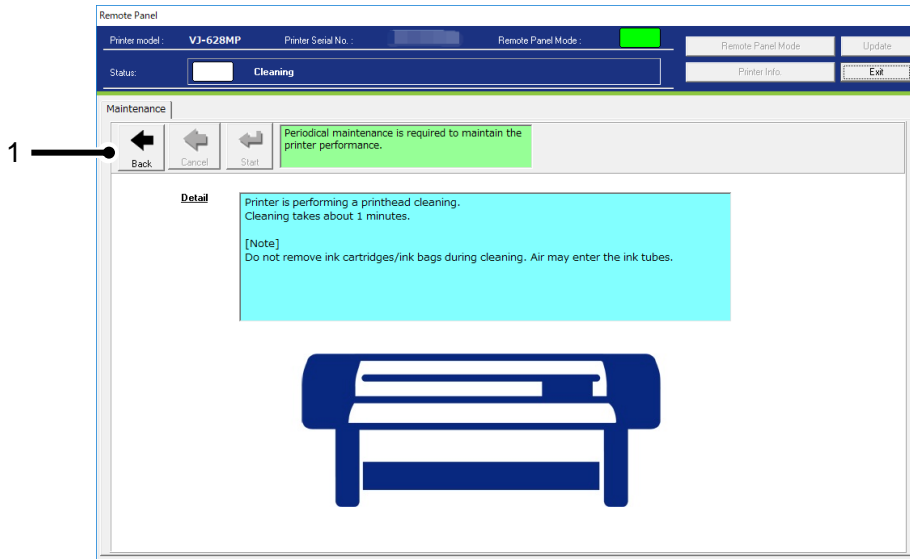

No.	Name	Description
1	Back	Go back to the Printer Control Main Menu.

NOTE

- After the cleaning is complete, the printer automatically moves the print head to the daily maintenance position.
- Do not remove ink cartridges/ink bags during cleaning. Air may enter the ink tubes.

4) Error confirmation during cleaning

If an error occurs during cleaning and the cleaning is interrupted, correct the error displayed on the screen.

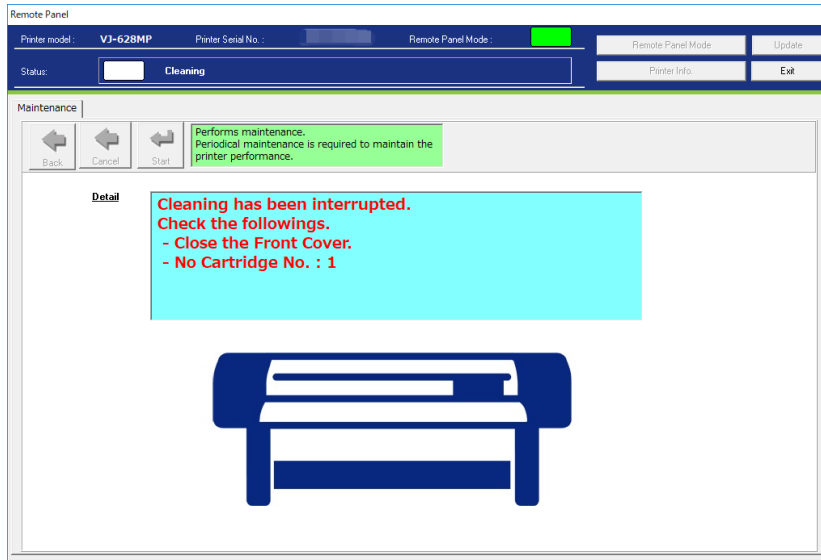

5) Performing maintenance

Daily maintenance is being performed in the printer.

After daily maintenance is completed, press Operation key on the printer panel.

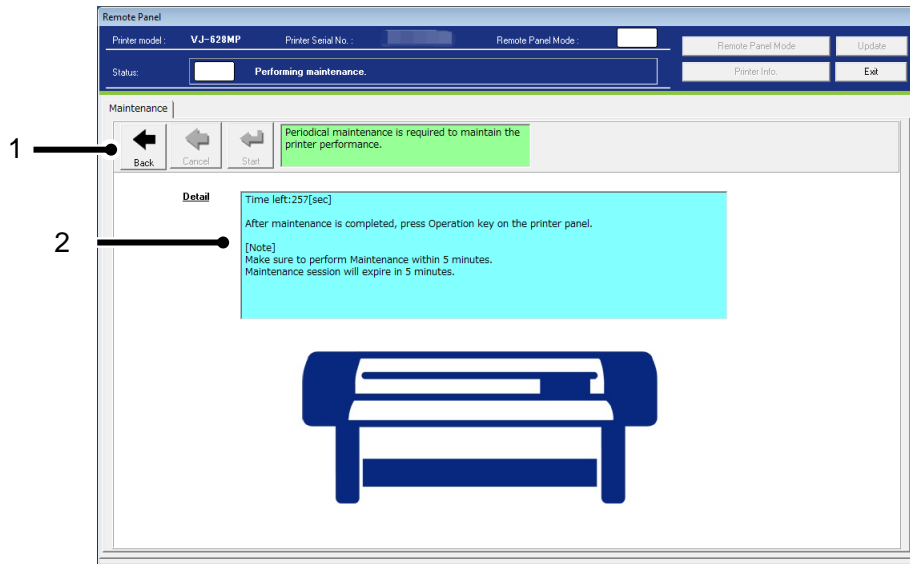

No.	Name	Description
1	Back	Go back to the Printer Control Main Menu.
2	Detail	Daily maintenance elapsed time is displayed.

NOTE

- After Daily maintenance is completed, make sure to press Operation key on the printer panel.
- Since your session will expire in 5 minutes, perform Daily maintenance within 5 minutes.
If your session has expired, finish Daily maintenance.

(3) Soak Cleaning

Remotely perform soak cleaning.

1) Check Printer Status

Before performing soak cleaning, check the printer status.

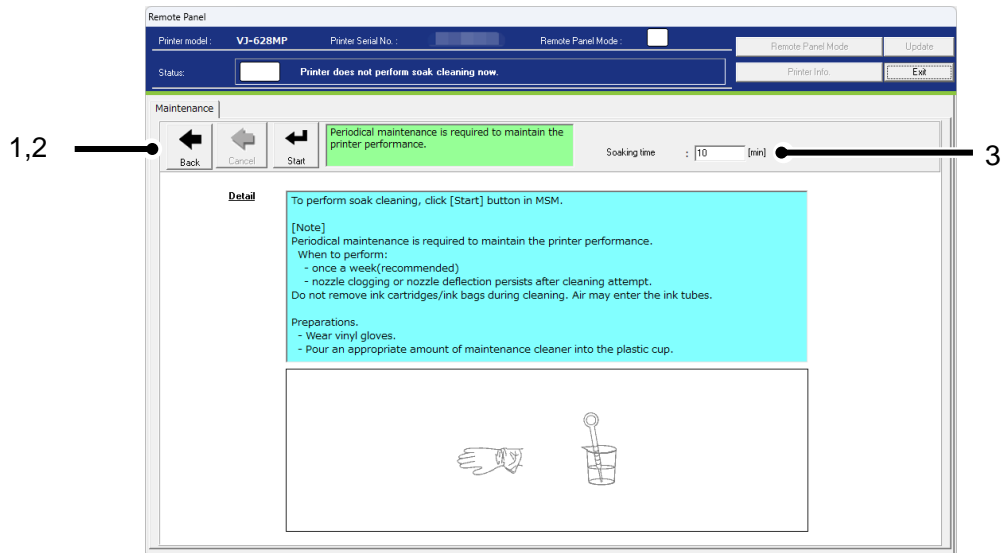

No.	Name	Description
1	Back	Go back to the Printer Control Main Menu.
2	Enter	Instruct the printer to perform Soak Cleaning.
3	Soaking time	Set soaking time. Setting :1 Min ~ < 10 Min > ~ 99 Min Unit :1 Min

2) Waiting to press [Operation] button in printer.

Before performing soak cleaning, press Operation key on the printer panel and then start soak cleaning.

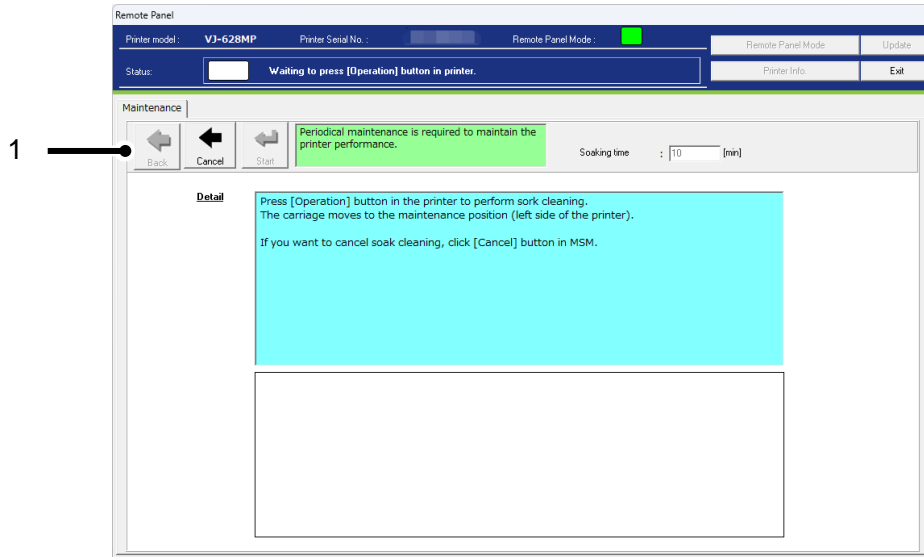

No.	Name	Description
1	Cancel	Cancel to perform soak cleangin.

NOTE

- Before starting soak cleaning, make sure to press Operation key on the printer panel.

3) Preparing for soak cleaning

The printer is now preparing for soak cleaning. Please refer to the manual for preparation.

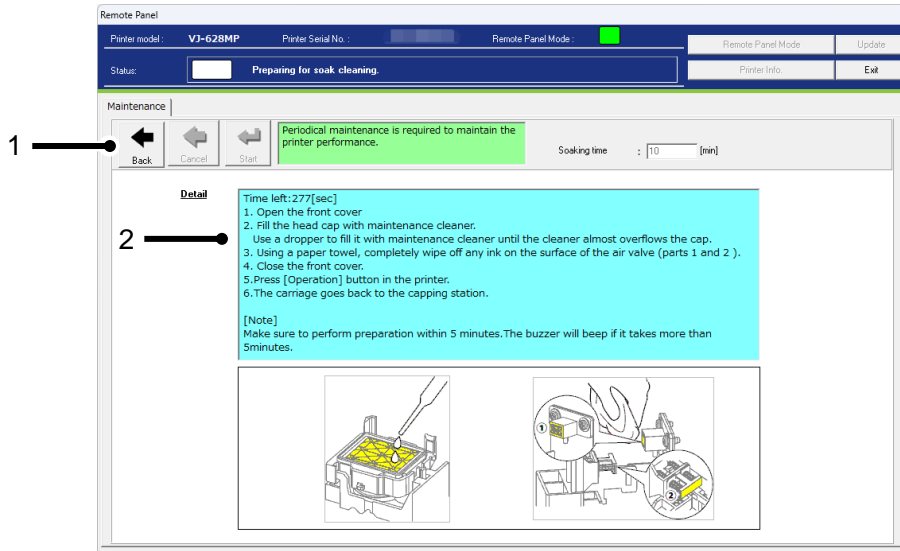

No.	Name	Description
1	Back	Go back to the Printer Control Main Menu.
2	Detail	Displays the time remaining for preparation.

NOTE

- Please since your session will expire in 5 minutes, perform preparing within 5 minutes.

4) Soaking

Printer is performing "soak". Please wait for a while.

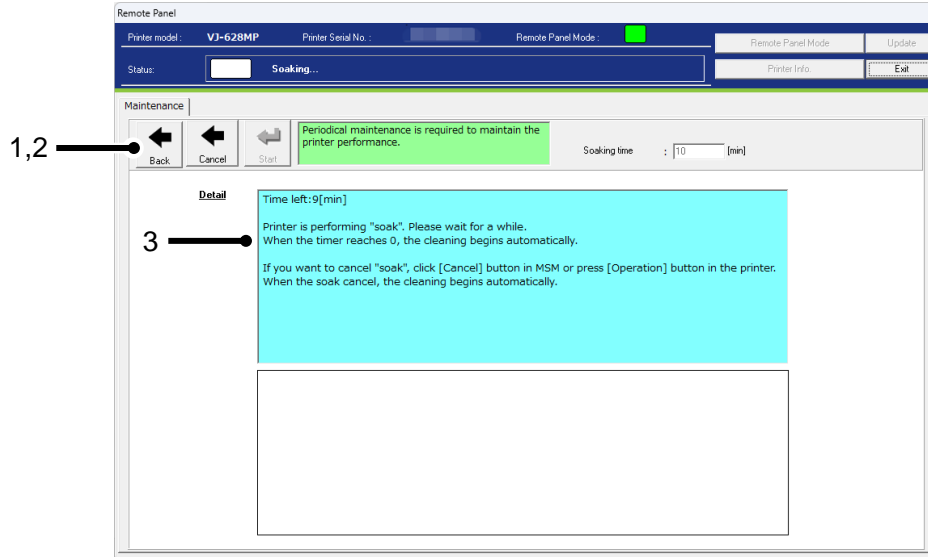

No.	Name	Description
1	Back	Go back to the Printer Control Main Menu.
2	Cancel	Cancel the soaking. After canceling, the cleaning process will begin.
3	Detail	Displays the time remaining for soaking.

5) Cleaning

Printer is performing "cleaning". Please wait for a while.

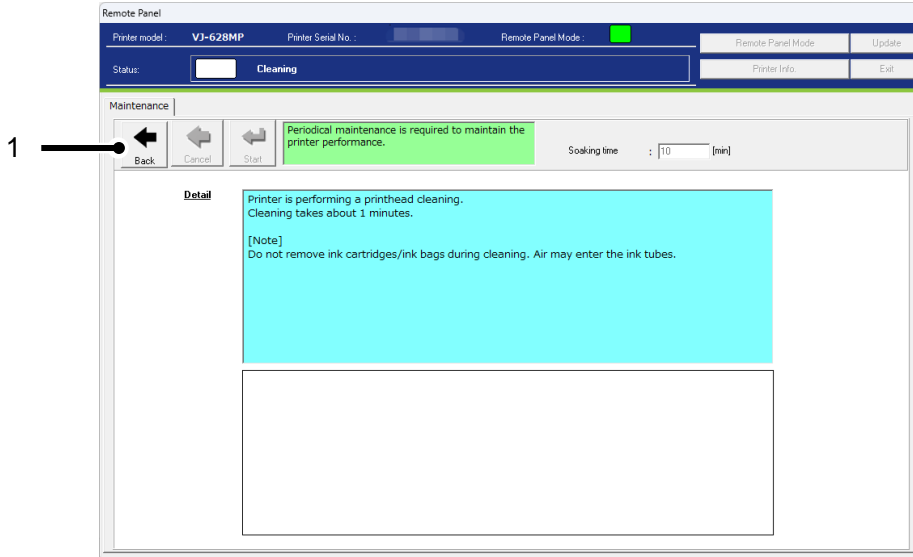

No.	Name	Description
1	Back	Go back to the Printer Control Main Menu.

6) Error confirmation during cleaning

If an error occurs during cleaning and the cleaning is interrupted, correct the error displayed on the screen.

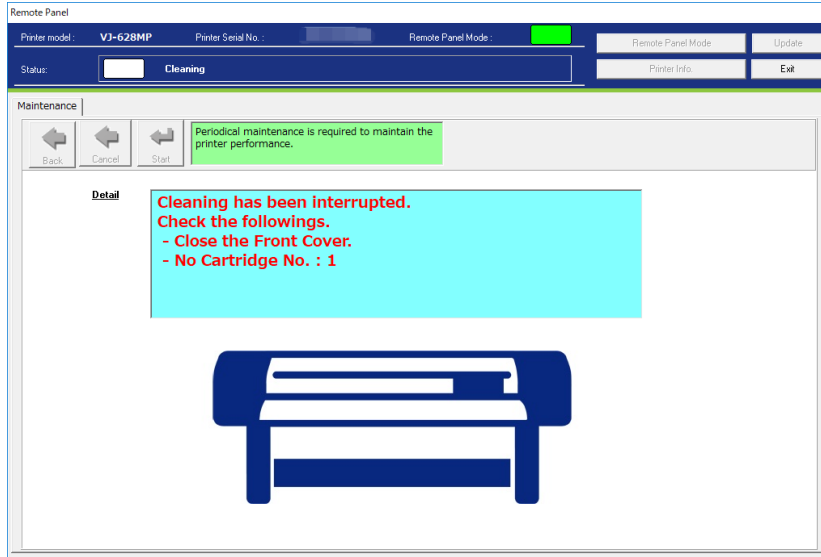

13.1.3.4. Cleaning

Performs head cleaning.

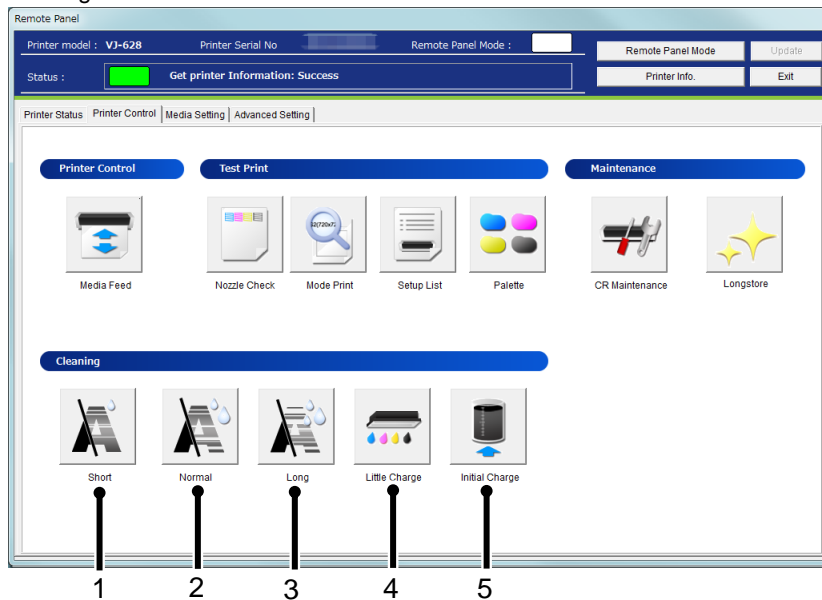

No.	Name	Description
1	Short Cleaning	Discharges smaller amount of ink compared to "Normal".
2	Normal Cleaning	Select this mode normally.
3	Long Cleaning	Discharges larger amount of ink compare to "Normal". Used when the print head does not improve by normal Head cleaning.
4	Little Charge	Refills a small amount of ink. Charge a small amount of ink when printing is not stable after initial ink charge.
5	Initial Charge	Perform initial ink charge. Refer to the (1)Initial Charge for the details.

NOTE

- Do not remove ink cartridges/ink bags during cleaning. Air may enter the ink tubes.

(1) Initial Charge

Perform the initial ink charge after ink cartridges are inserted into the correct slots.

1) Empty Waste Ink Tank

Empty the waste ink tank before performing initial ink charge.

After disposing the waste ink, click [Start] button to reset the waste ink counter.

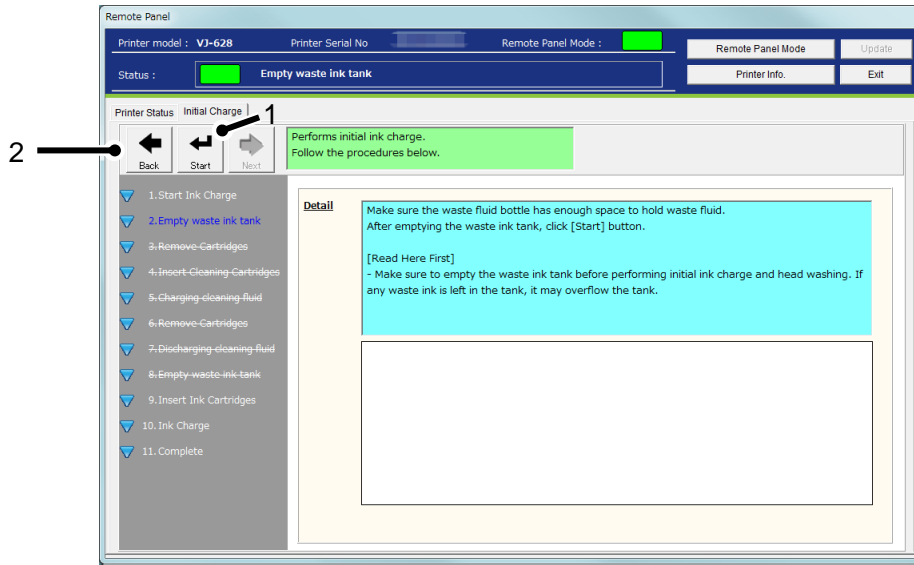

No.	Name	Description
1	Start	Reset the waste ink counter.
2	Back	Go back to the Printer Control Main Menu.

NOTE

- Initial charge produces waste ink. Make sure to empty the waste ink tank before performing the initial ink charge. If waste ink is left in the tank, it may overflow the tank.

2) Insert Ink Cartridges

After the counter reset, insert the ink cartridges.

After the ink cartridges are inserted into the correct slots, the printer will start initial ink charge.

[VJ-628/628X]

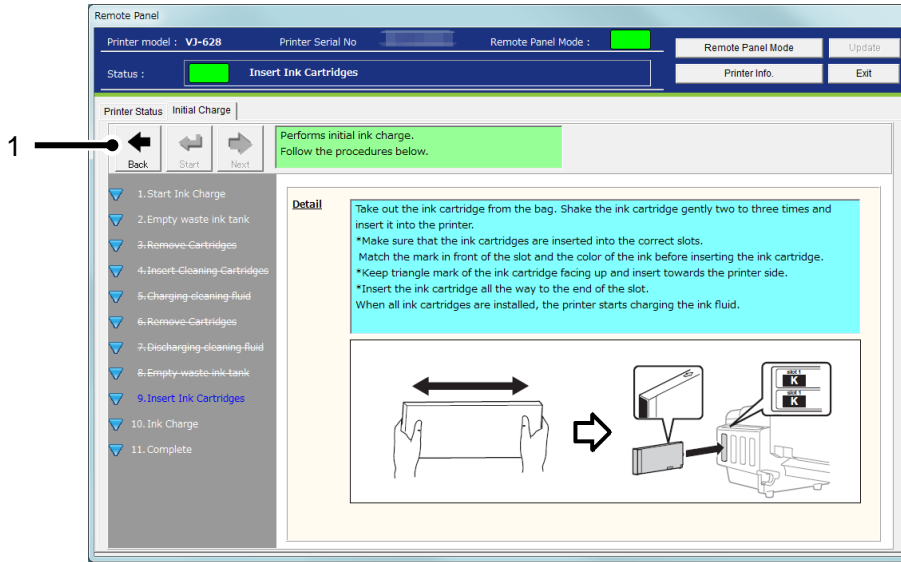

[VJ-628MP]

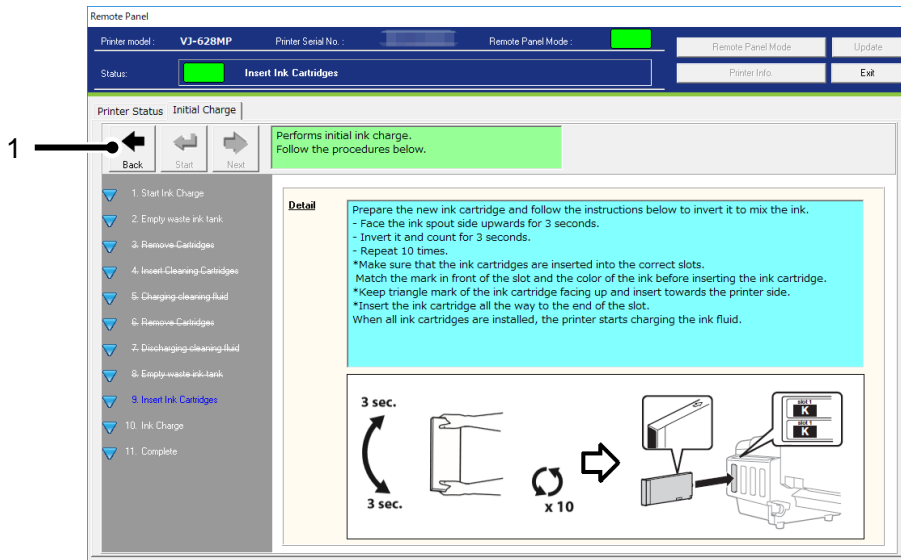

No.	Name	Description
1	Back	Go back to the Printer Control Main Menu.

3) Ink Charge

The printer is charging inks.

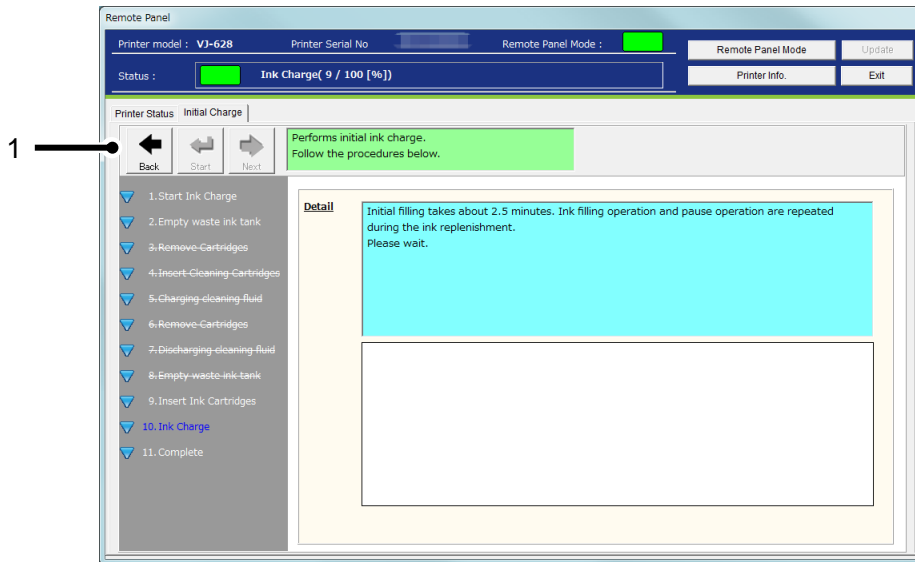

No.	Name	Description
1	Back	Go back to the Printer Control Main Menu.

4) Complete

Initial ink charge has been completed.

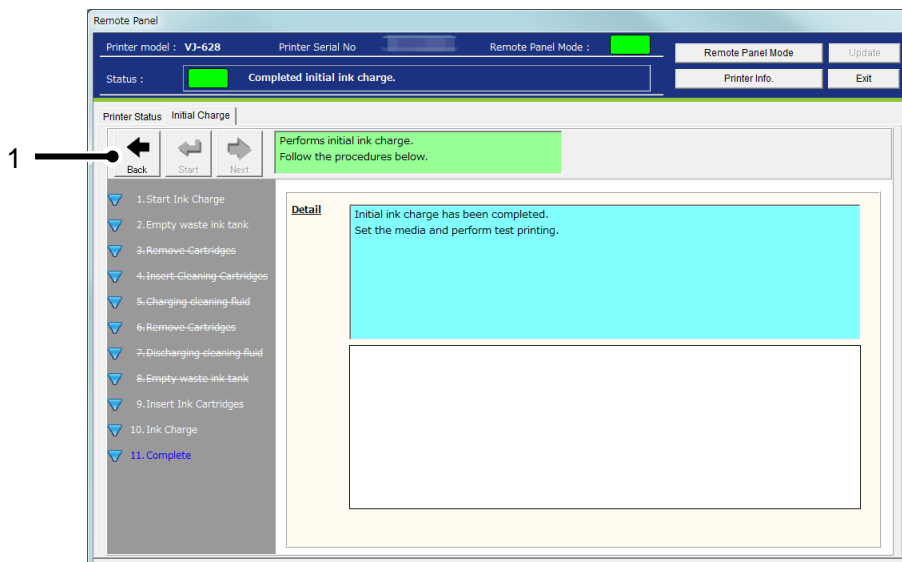

No.	Name	Description
1	Back	Go back to the Printer Control Main Menu.

13.1.3.5. Ink Discharge

Remotely perform ink discharge.

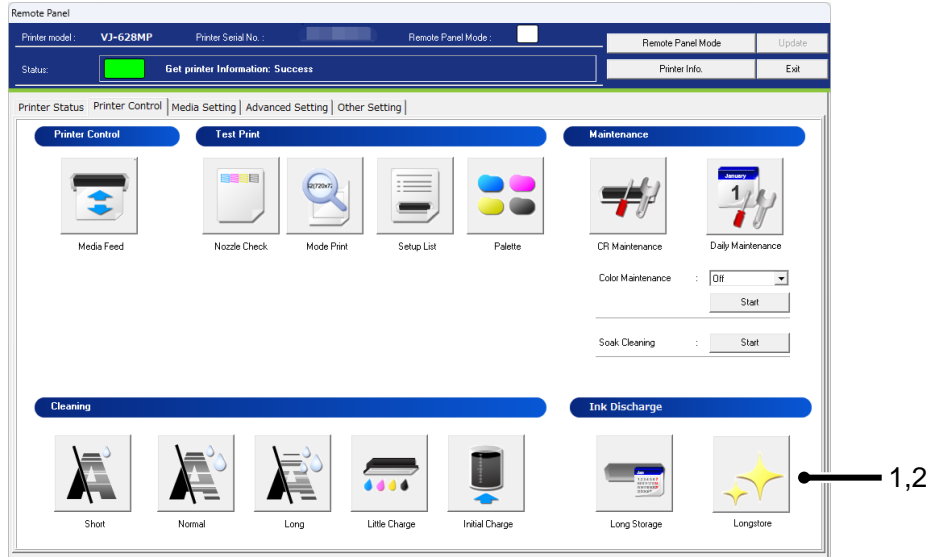

No.	Name	Description
1	Long Storage *1	Remotely perform LongStorage.
2	LongStore	Remotely perform LongStore.

NOTE

- *1 This function is available for VJ-628MP.

(1) Long Storage

If you leave the printer for over 2 week, perform Long Storage to clean the entire ink system and store the printer with turned off.

NOTE

- Make sure to use the dedicated cleaning fluid.

1) Start LongStorage

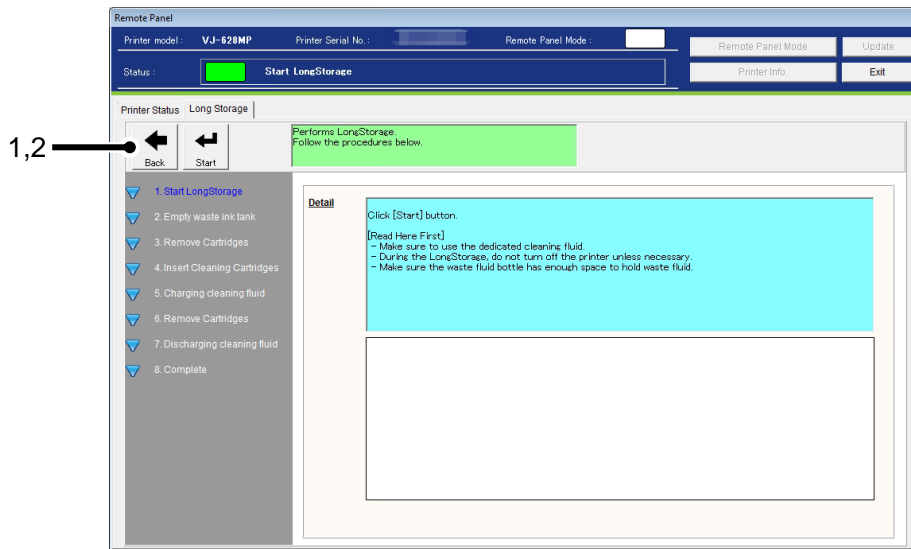

No.	Name	Description
1	Back	Go back to the Printer Control Main Menu.
2	Start	Start Long Storage.

2) Empty Waste Ink Tank

Empty the waste ink tank before performing “Longstorage” maintenance.

After disposing the waste ink, click [Start] button to reset the waste ink counter.

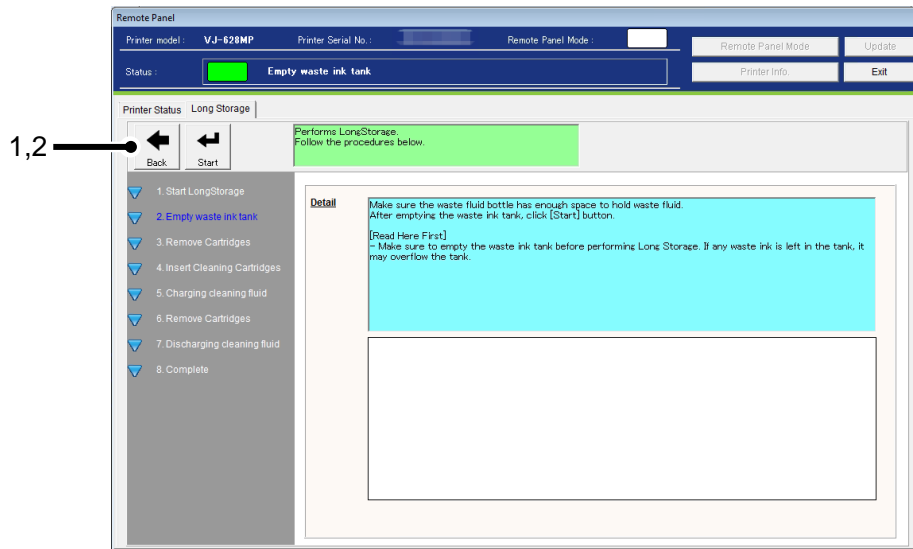

No.	Name	Description
1	Back	Go back to the Printer Control Main Menu.
2	Start	Reset the waste ink counter.

NOTE

- Performing “Longstorage” maintenance produces waste ink. Make sure to empty the waste ink tank before this operation. If waste ink is left in the tank, it may overflow the tank.

3) Remove Cartridges

This message is displayed when any cartridge is inserted in the printer.

If no cartridge is inserted, this message will be skipped.

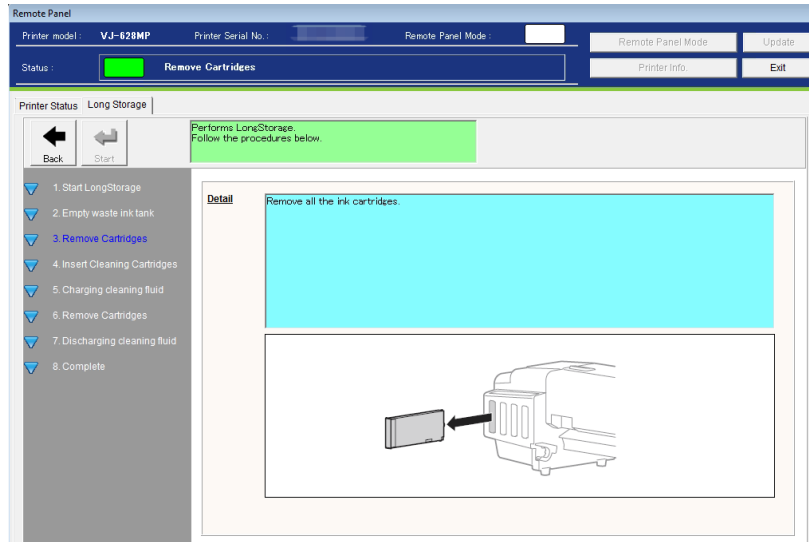

4) Insert Cleaning Cartridges

Insert cleaning cartridges to all the slots.

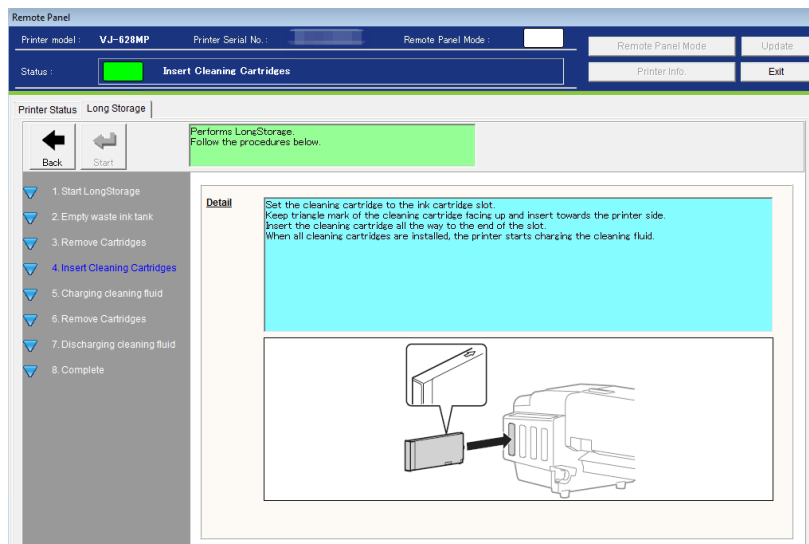

5) Charging cleaning fluid

After the cleaning cartridges are inserted into the slots, the printer will start charging cleaning fluid.

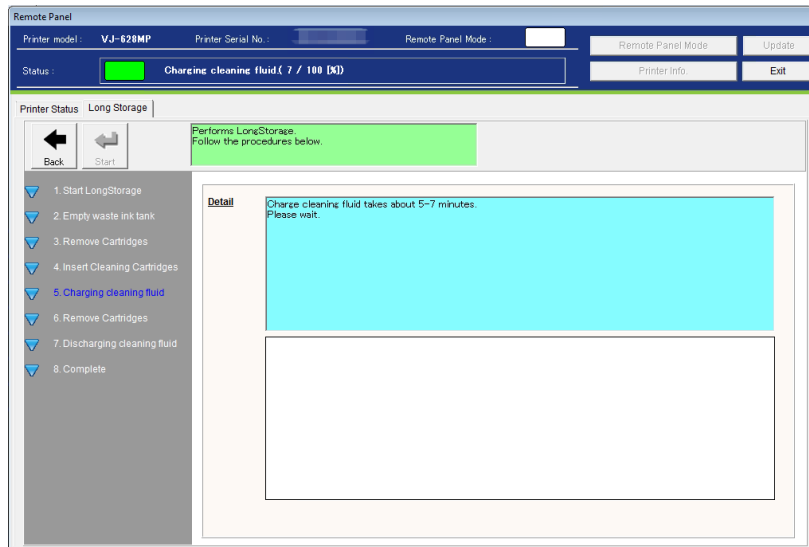

6) Remove Cartridges

After charging cleaning fluid, remove all the cleaning cartridges.

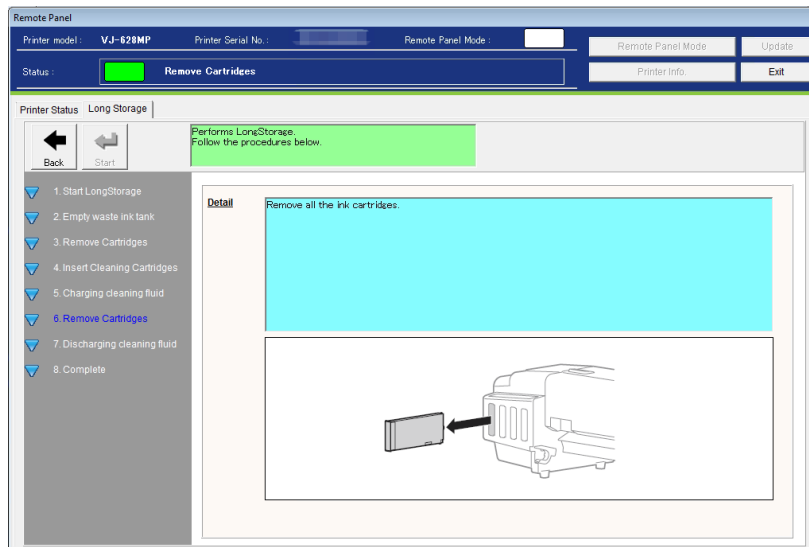

7) Discharging cleaning fluid

After removing the cleaning cartridges, the printer will discharge cleaning fluid.

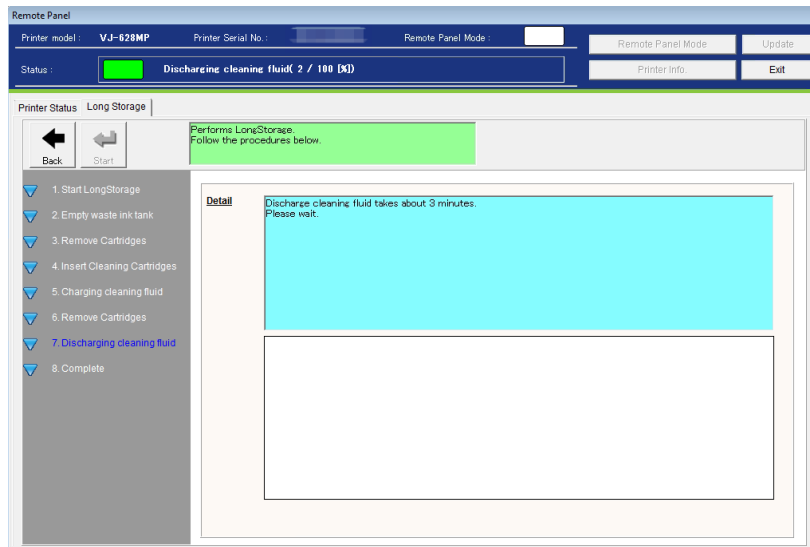

8) Complete

“Longstorage” maintenance has been completed.

Turn off the printer.

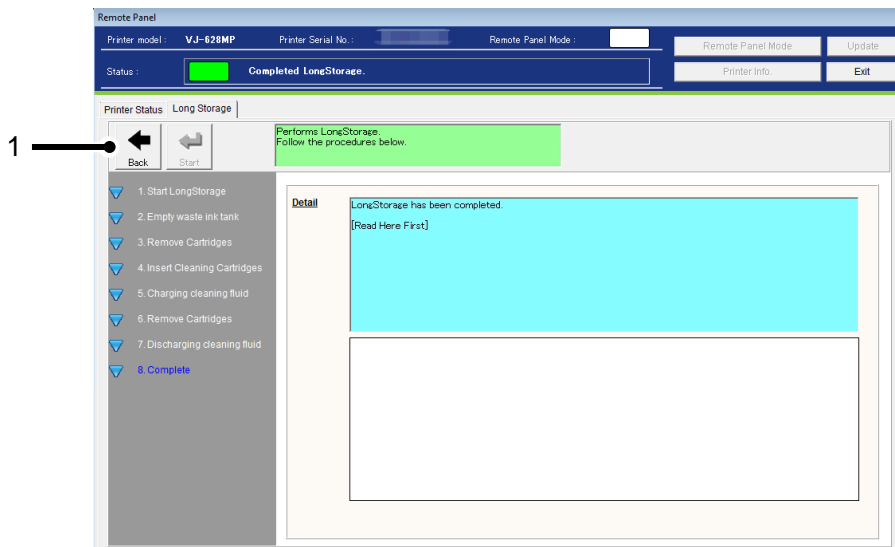

No.	Name	Description
1	Back	Go back to the Printer Control Main Menu.

(2) Longstore

Wash the print head with the cleaning fluid.

NOTE

- To perform “Longstore”, you will need cleaning cartridges (or cleaning bags).
- Make sure to use the dedicated cleaning fluid.
- If the version of the firmware is old or depending on the printer model you are using, the Longstore cleaning may not be cancelled in the middle of the process.
- If unable to cancel, you have to do it from the beginning to the end. So please be careful when you perform Longstore.

1) Confirmation

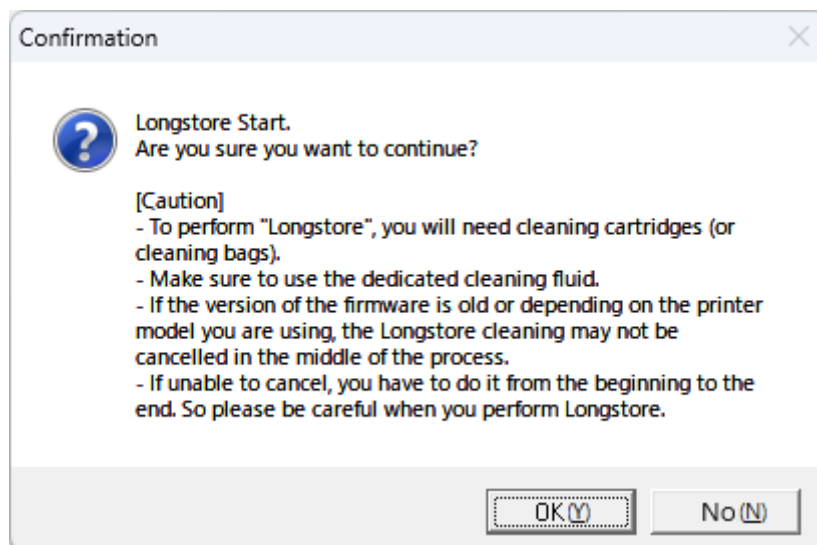

2) Start LongStore

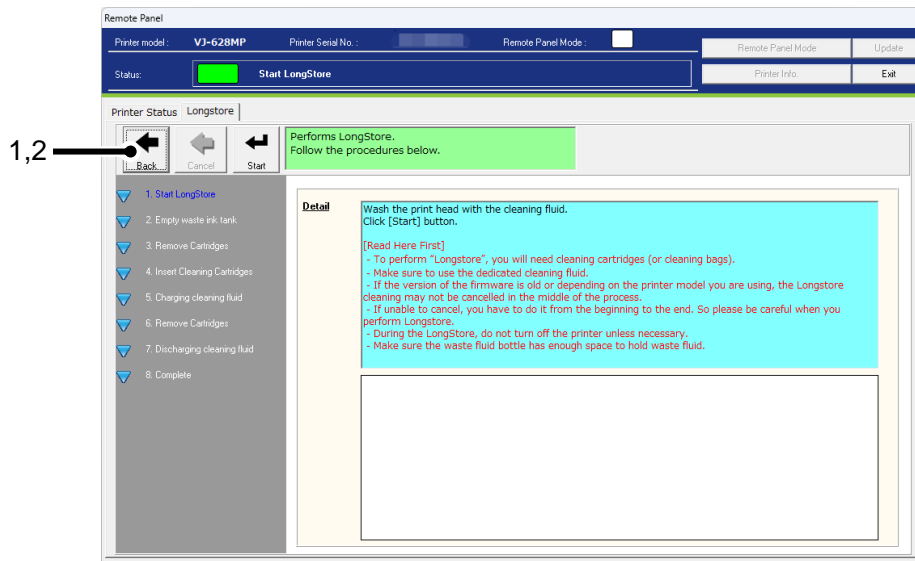

No.	Name	Description
1	Start	Start LongStore.
2	Back	Go back to the Printer Control Main Menu.

3) Empty Waste Ink Tank

Empty the waste ink tank before performing “Longstore” maintenance.

After disposing the waste ink, click [Start] button to reset the waste ink counter.

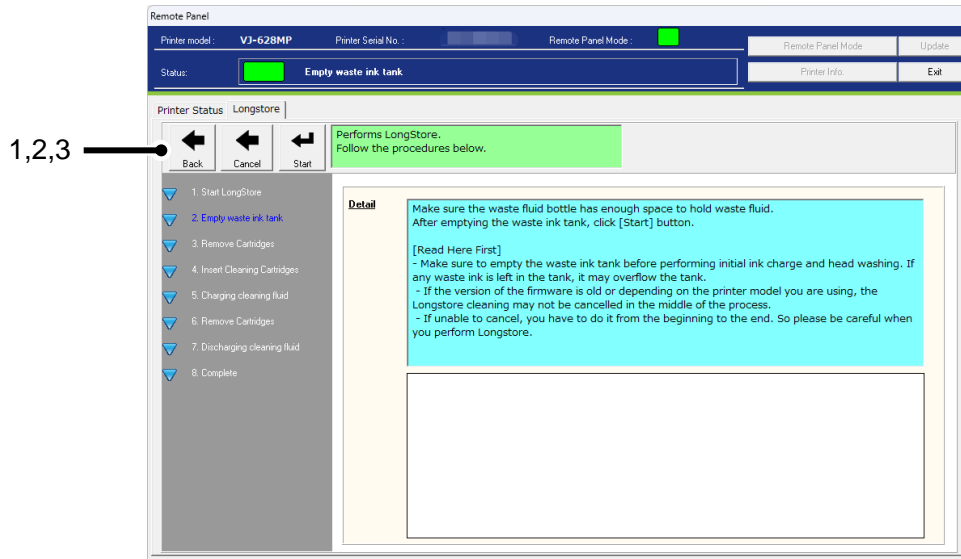

No.	Name	Description
1	Back	Go back to the Printer Control Main Menu.
2	Cancel	Cancel Longstore.
3	Start	Reset the waste ink counter.

NOTE

- Performing “Longstore” maintenance produces waste ink. Make sure to empty the waste ink tank before this operation. If waste ink is left in the tank, it may overflow the tank.
- If the version of the firmware is old or depending on the printer model you are using, the Longstore cleaning may not be cancelled in the middle of the process.

4) Remove Cartridges

This message is displayed when any cartridge is inserted in the printer.

If no cartridge is inserted, this message will be skipped.

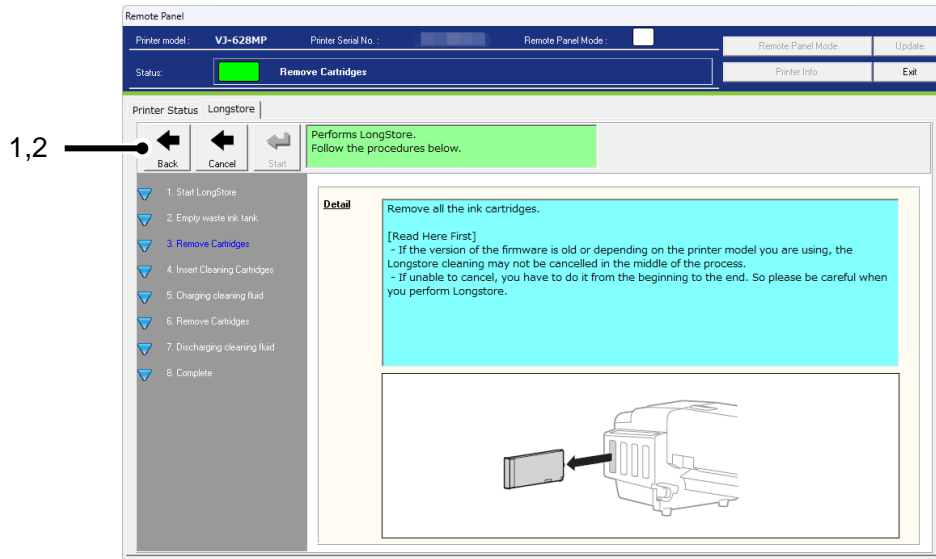

No.	Name	Description
1	Back	Go back to the Printer Control Main Menu.
2	Cancel	Cancel Longstore.

NOTE

- If the version of the firmware is old or depending on the printer model you are using, the Longstore cleaning may not be cancelled in the middle of the process

5) Insert Cleaning Cartridges

Insert cleaning cartridges to all the slots.

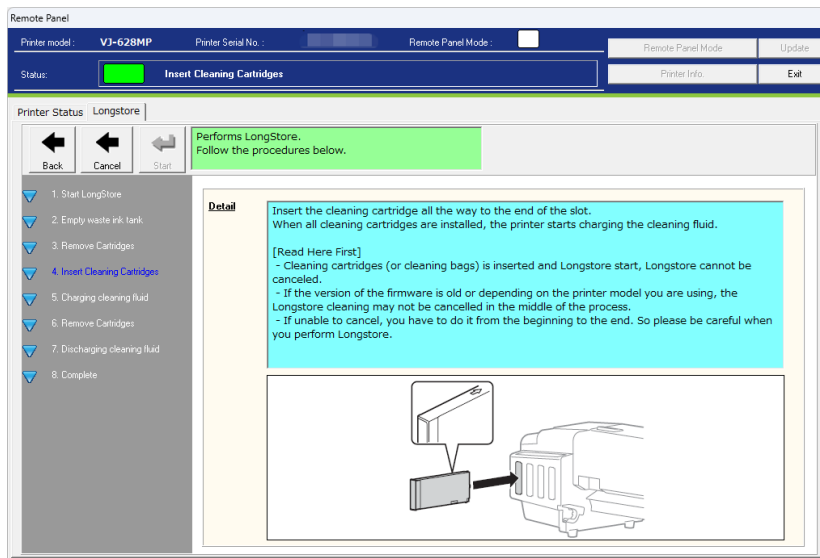

NOTE

- Cleaning cartridges (or cleaning bags) is inserted and Longstore start, Longstore cannot be canceled.
- If the version of the firmware is old or depending on the printer model you are using, the Longstore cleaning may not be cancelled in the middle of the process

6) Charging cleaning fluid

After the cleaning cartridges are inserted into the slots, the printer will start charging cleaning fluid.

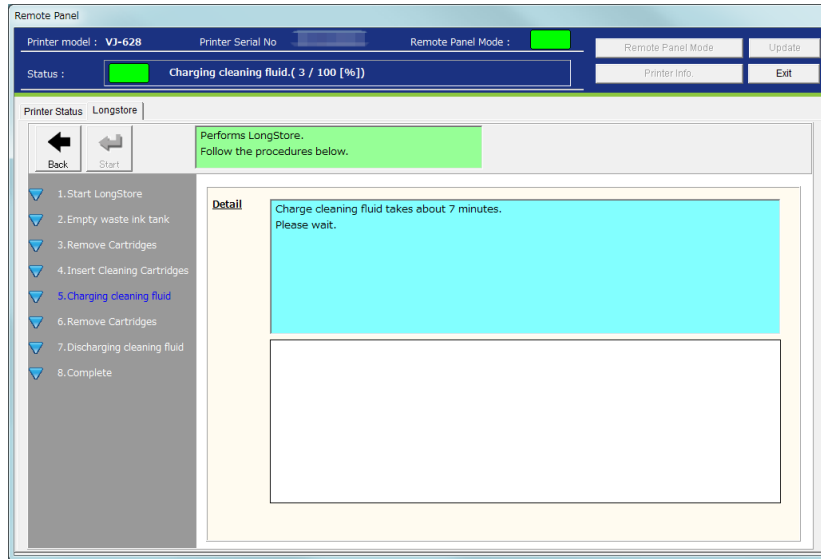

NOTE

- Longstore cannot be canceled, you have to do the end.

7) Remove Cartridges

After charging cleaning fluid, remove all the cleaning cartridges.

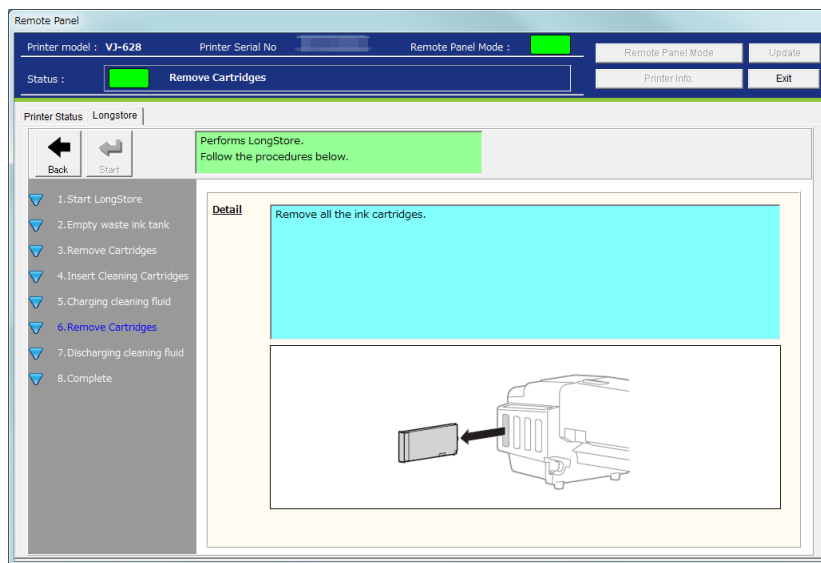

8) Discharging cleaning fluid

After removing the cleaning cartridges, the printer will discharge cleaning fluid.

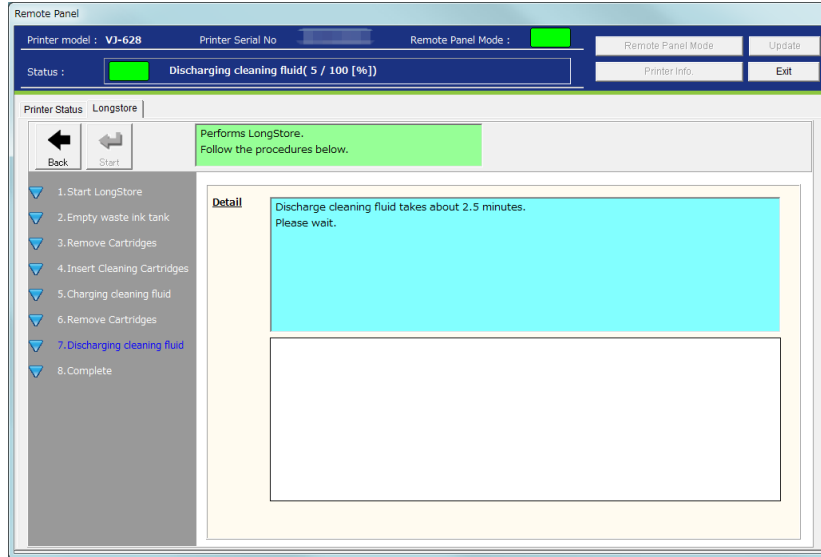

9) Complete

“Longstore” maintenance has been completed.

Restart the printer and perform initial ink charge.

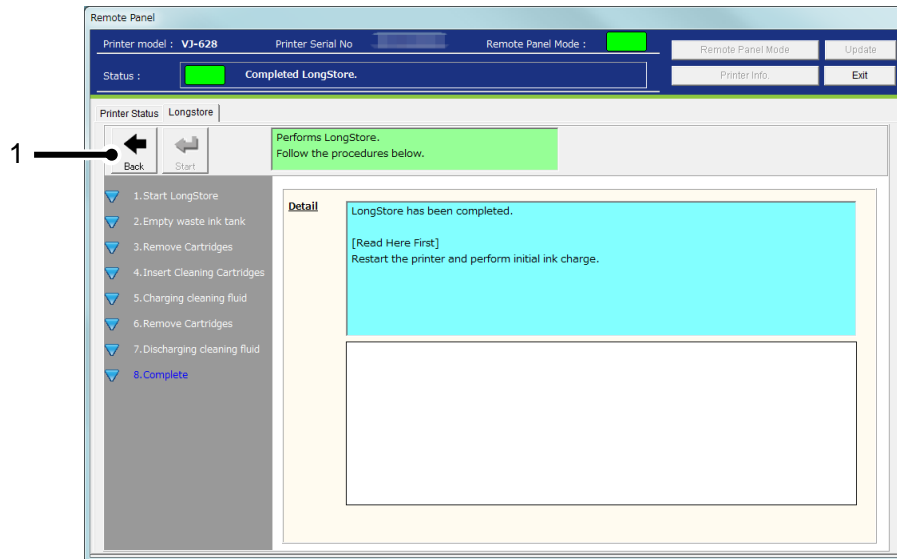

No.	Name	Description
1	Back	Go back to the Printer Control Main Menu.

13.1.4 Media Setting

Check and change the media setting.

If you use more than one media, you can store the each media setting including the heater temperature from this menu.

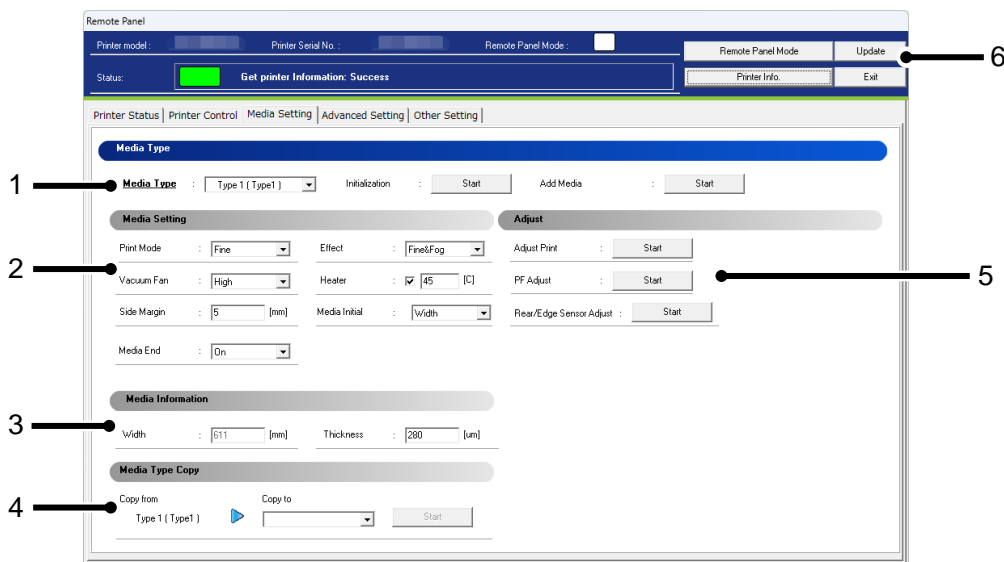

No.	Name	Description
1	Media Type	Check and change the media type loaded in the printer.
2	Media Setting	Check and change the current media setting.
3	Media Information	Check and change the media information set in the printer.
4	Media Type Copy	Copy the current media setting to other Media Type.
5	Adjust	Check and change the media adjust set in the printer.
6	Update	Change the media setting.

NOTE

- To change the setting, change the values or settings and then click [Update] button.
- Multiple settings can be changed at once.

13.1.4.1. Media Type

Check and change the Media Type loaded in the printer.

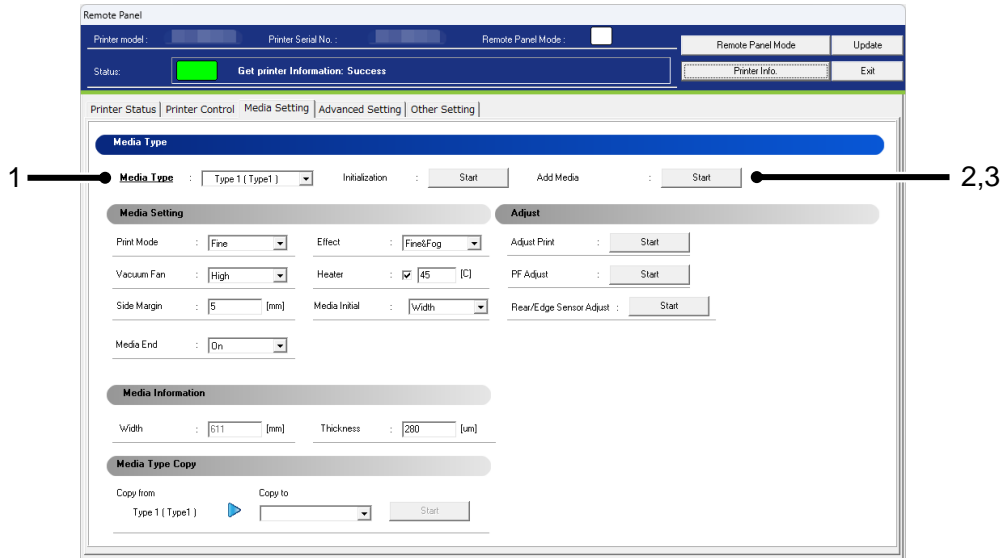

No.	Name	Description
1	Media Type	Check and change the Media Type loaded in the printer.
2	Initialization	Reset the Media Type currently loaded in the printer.
3	Add Media	Add a new media by following the wizard.

NOTE

- To change the setting, change the values or settings and then click [Update] button.

(1) Add Media

To add a new media, the Add Media wizard guides the users through the necessary setting or adjustment.

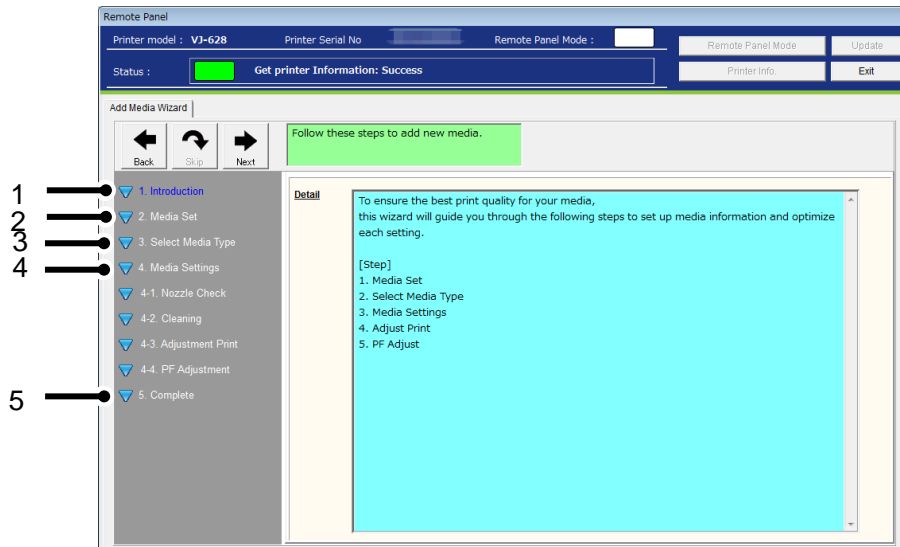

No.	Name	Description
1	Introduction	Explains how to add a new media.
2	Media Set	Explains how to load a media to the printer.
3	Select Media Type	Select a media type to be added.
4	Media Settings	Specify the media settings or perform adjustment to a new media.
5	Complete	Exit the wizard.

1) Introduction

Explains how to add a new media.

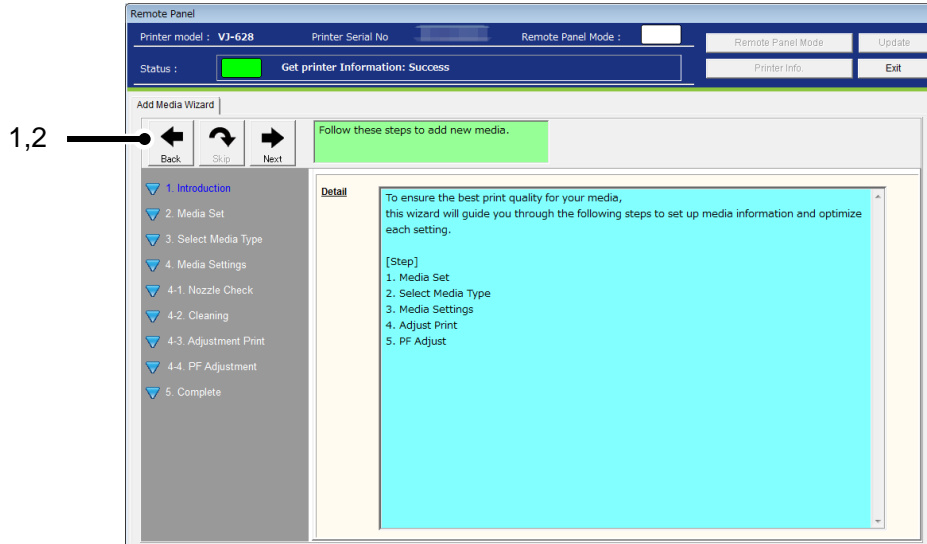

No.	Name	Description
1	Back	Cancel to add a new media and go back to the Media Setting tab.
2	Next	Proceed to the next setting.

2) Media Set

Explains how to load a media.

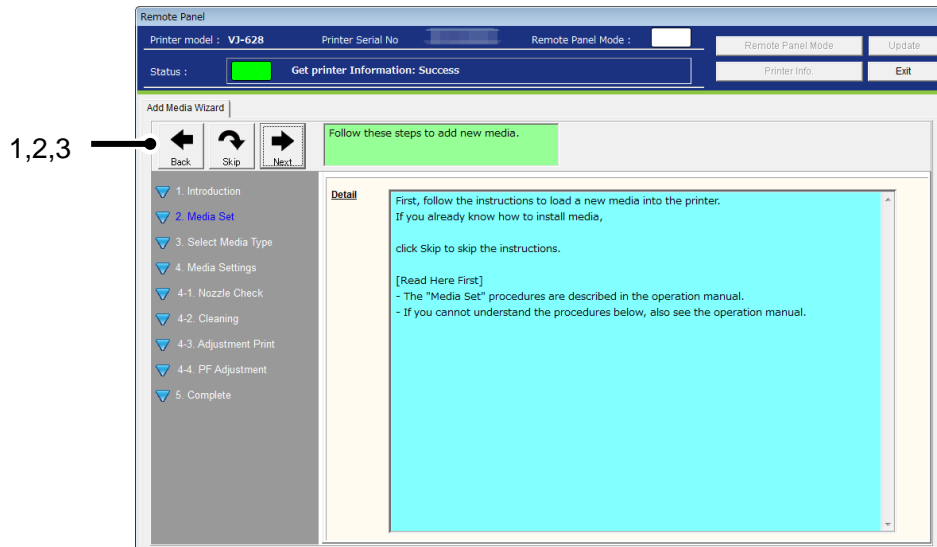

No.	Name	Description
1	Back	Go back to the previous menu.
2	Skip	Skip this menu to go to the Select Media Type menu.
3	Next	Proceed to the next setting.

2-1) Media Set: Step 1

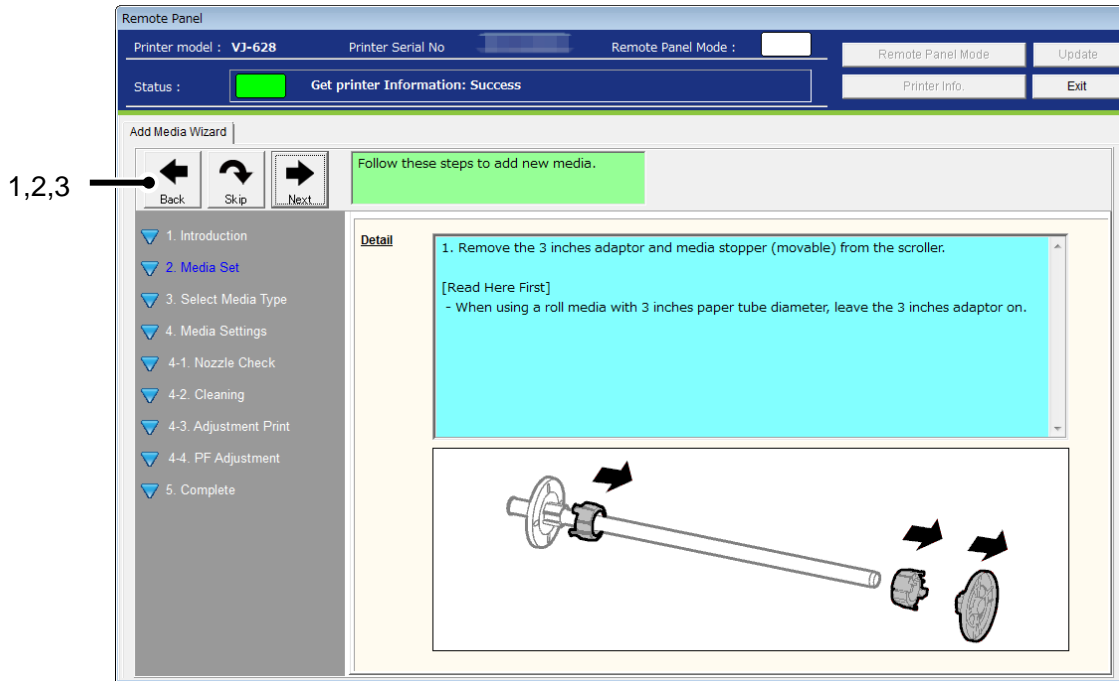

No.	Name	Description
1	Back	Go back to the previous menu.
2	Skip	Skip this menu to go to the Select Media Type menu
3	Next	Proceed to the next setting.

NOTE

- This button functions apply to the all "Media Set" menu pages.

2-2) Media Set: Step 2

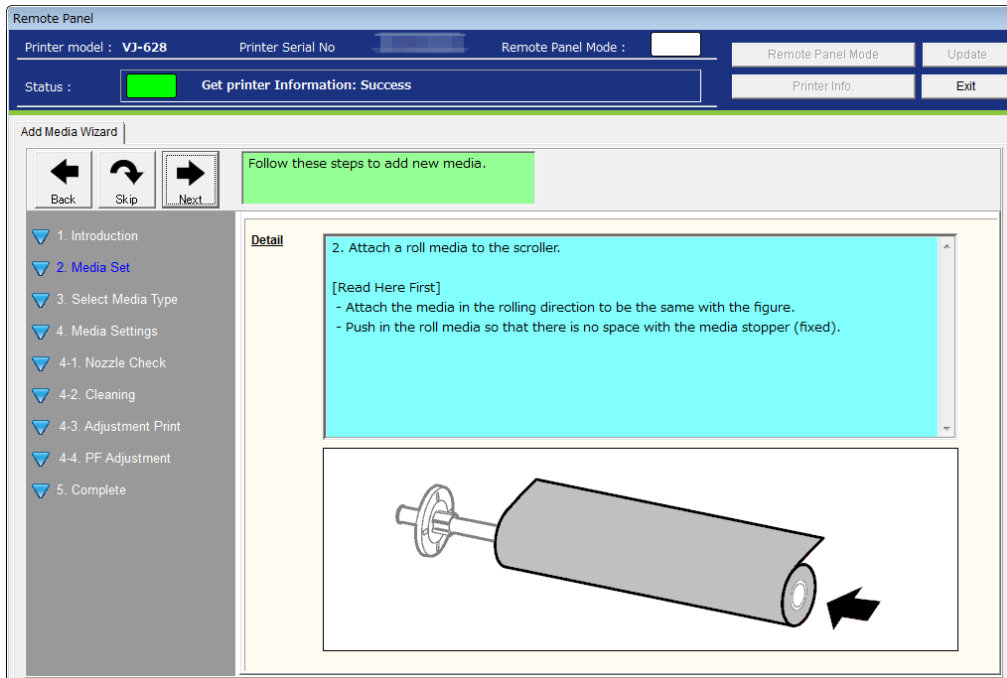

2-3) Media Set: Step 3

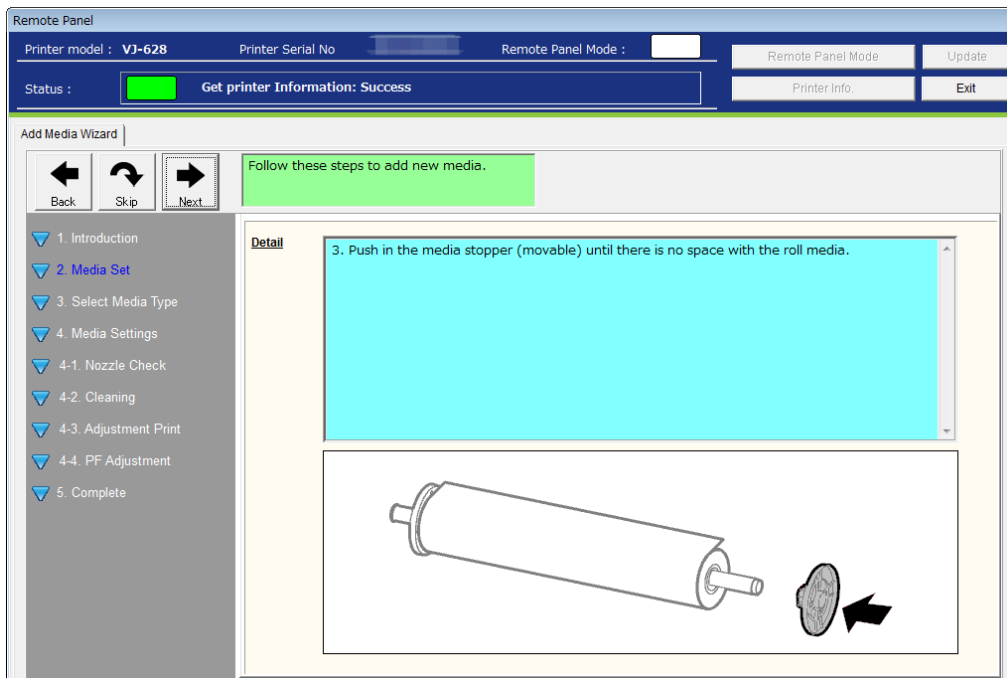

2-4) Media Set: Step 4

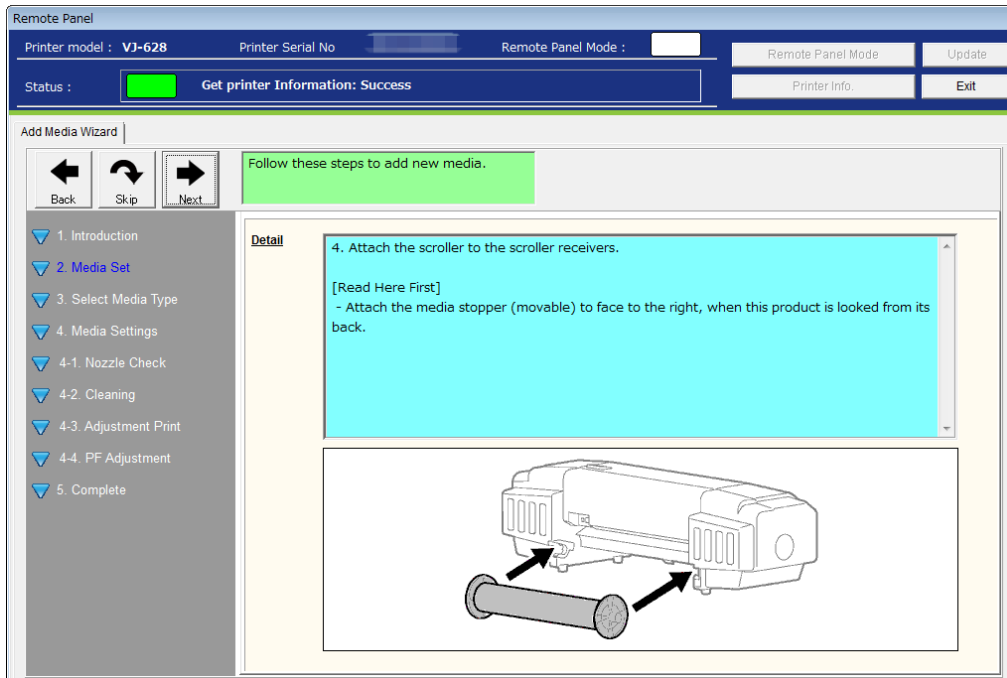

2-5) Media Set: Step 5

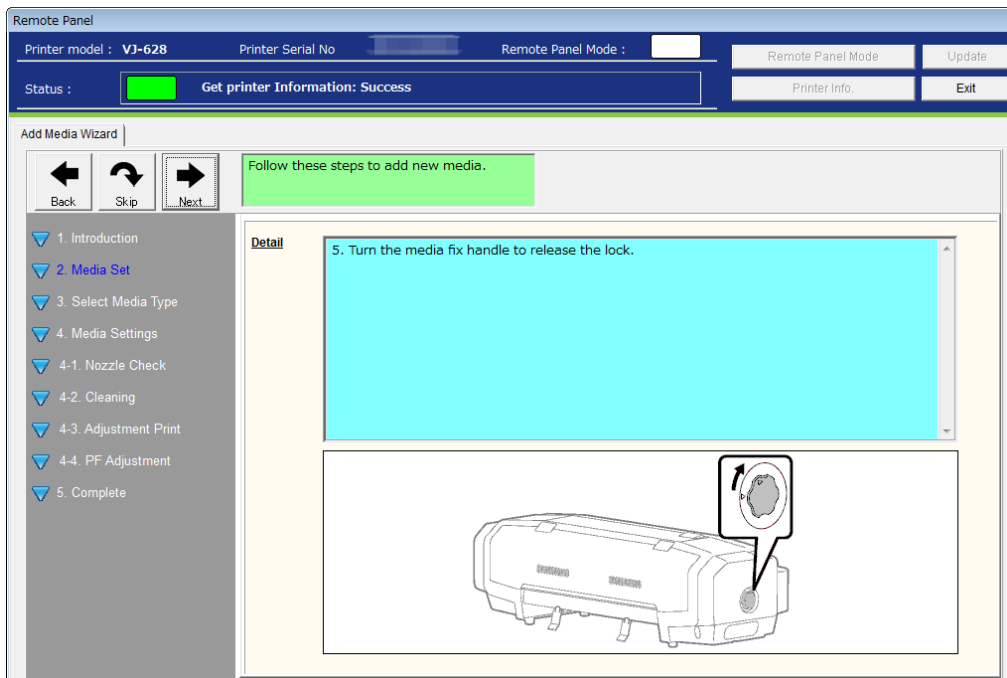

2-6) Media Set: Step 6

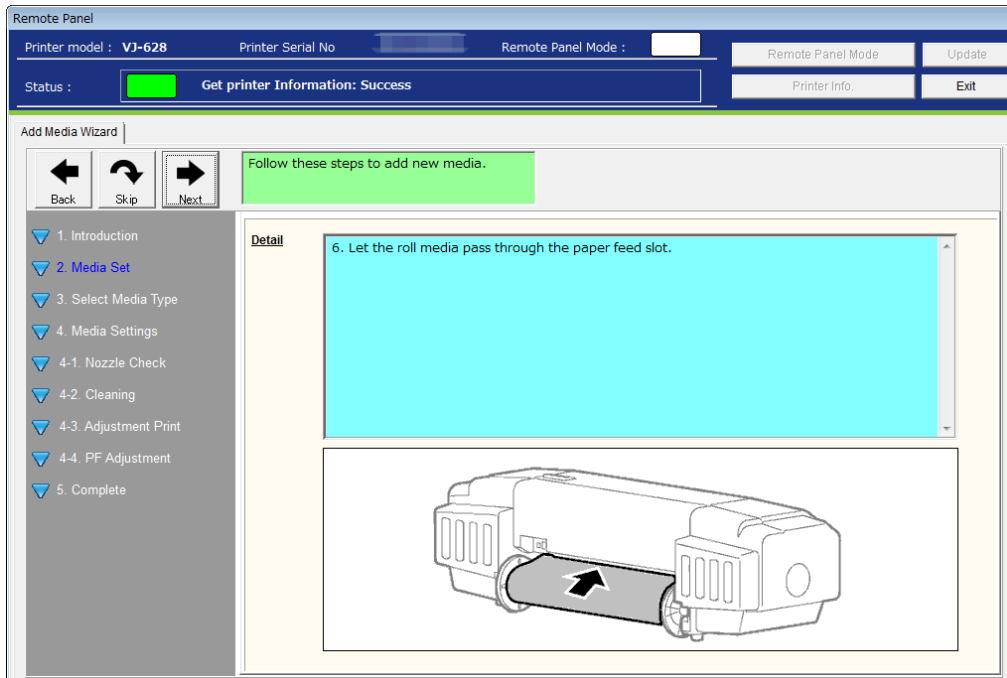

2-7) Media Set: Step 7

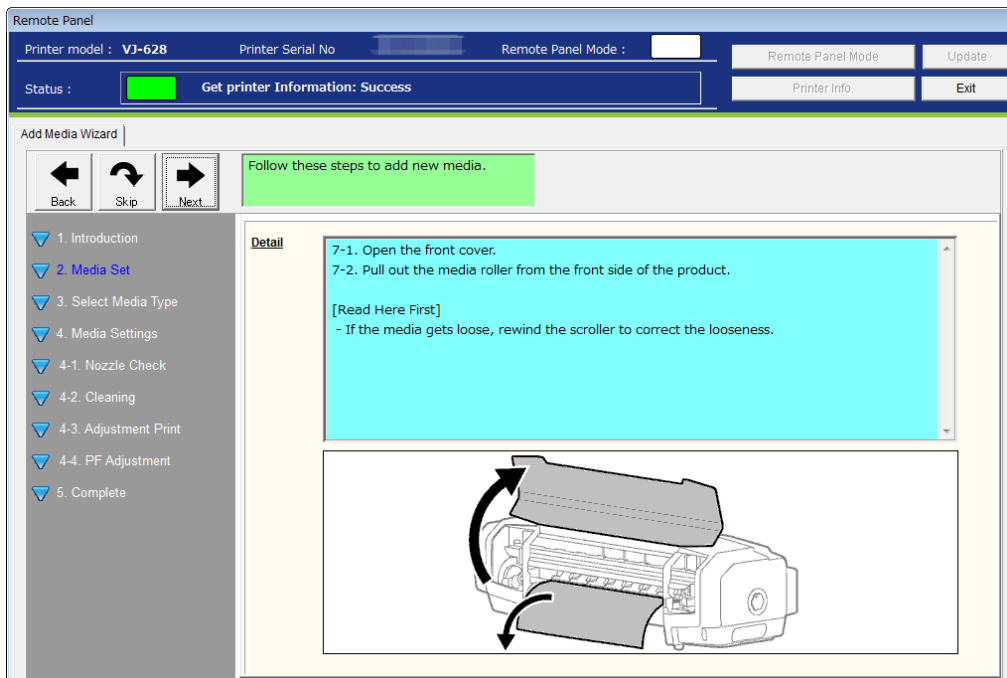

2-8) Media Set: Step 8

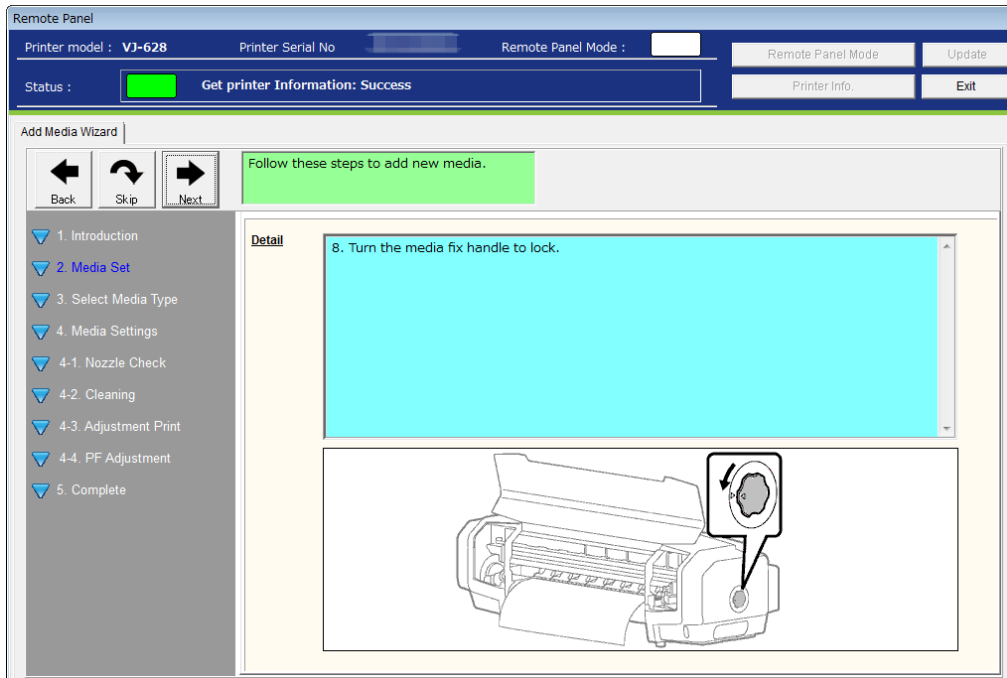

2-9) Media Set: Step 9

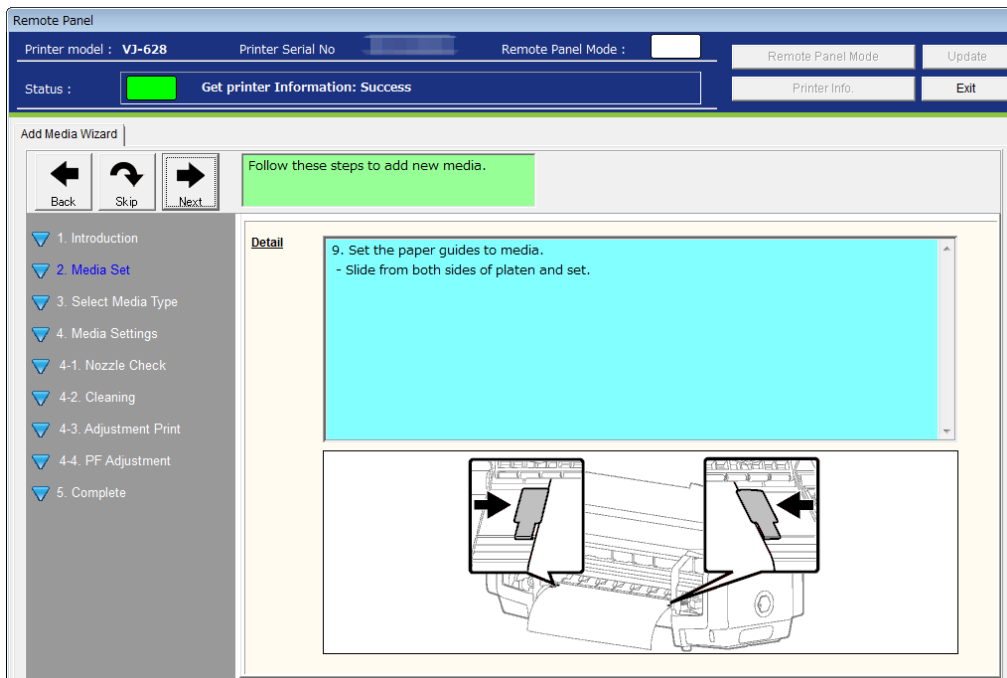

2-10)Media Set: Step 10

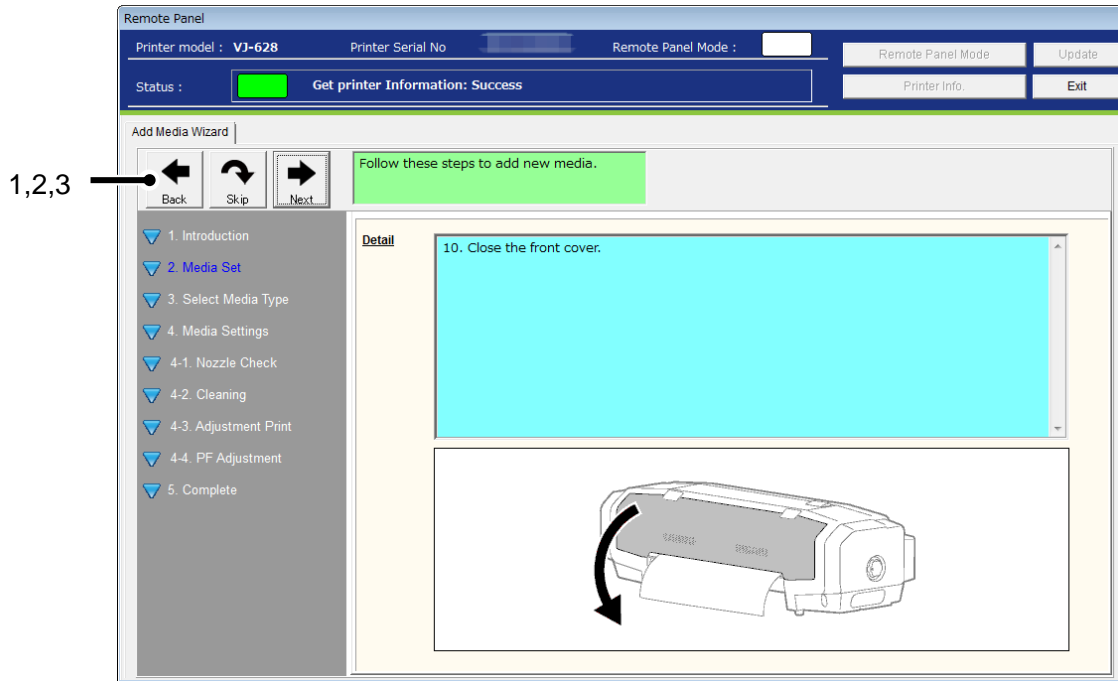

No.	Name	Description
1	Back	Go back to the previous menu.
2	Skip	Skip this menu to go to the Select Media Type menu.
3	Next	Proceed to the next setting.

3) Select Media Type

Register a new media in the printer.

Follow the wizard instructions for media registration.

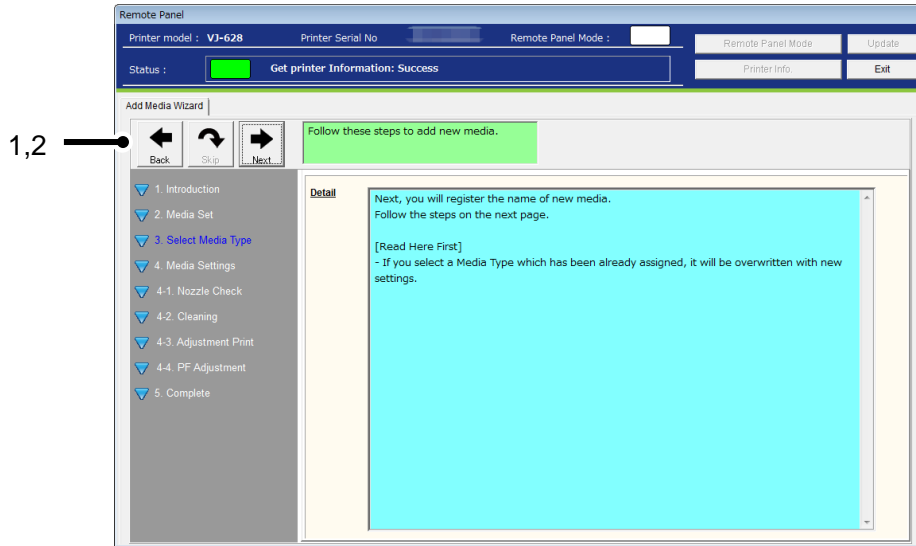

No.	Name	Description
1	Back	Go back to the previous menu.
2	Next	Proceed to the next setting.

NOTE

- This step cannot be skipped.

3-1) Select Media Type

Select a media type for a new media.

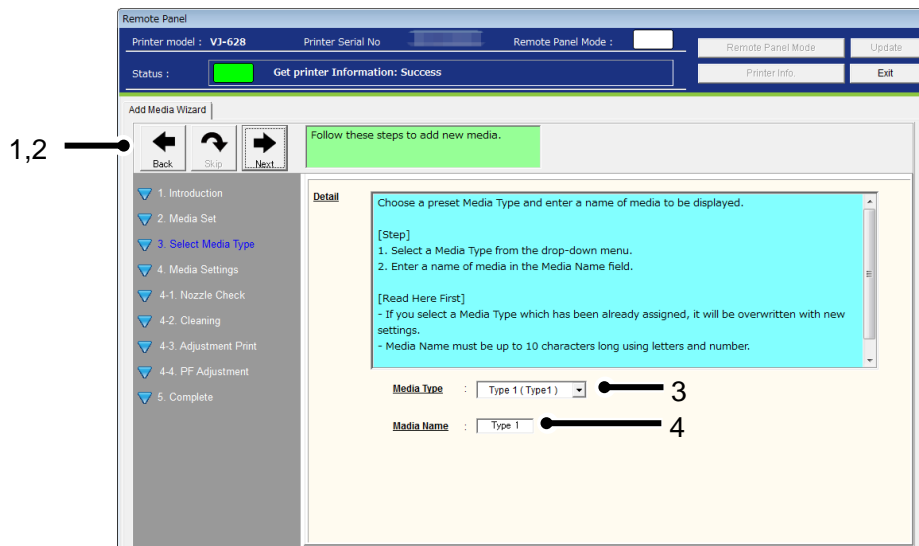

No.	Name	Description
1	Back	Go back to the previous menu.
2	Next	Register a media type.
3	Media Type	Select a media type from the drop-down menu.
4	Media Name	Enter a media name.

NOTE

- This step cannot be skipped.
- To edit the media name, place the cursor to the desired position.
- Up to 10 single-byte alphanumeric characters can be entered for the media name.

4) Media Settings

Specify the appropriate media settings to achieve the optimal print quality.

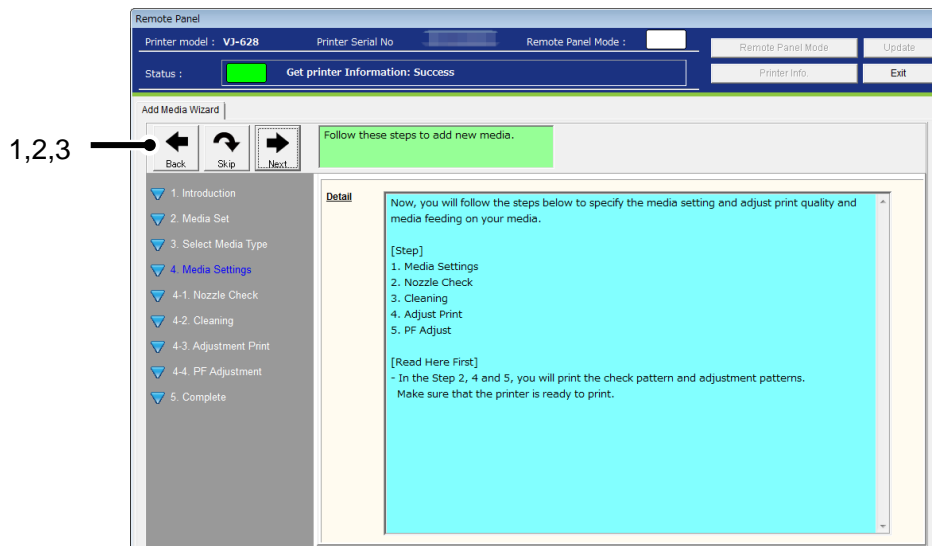

No.	Name	Description
1	Back	Go back to the previous menu.
2	Skip	Skip this menu to exit the wizard.
3	Next	Proceed to the next setting.

NOTE

- When skipping this menu, no change is applied to the current settings or adjustments.

4-1) Media Settings

Specify the media settings.

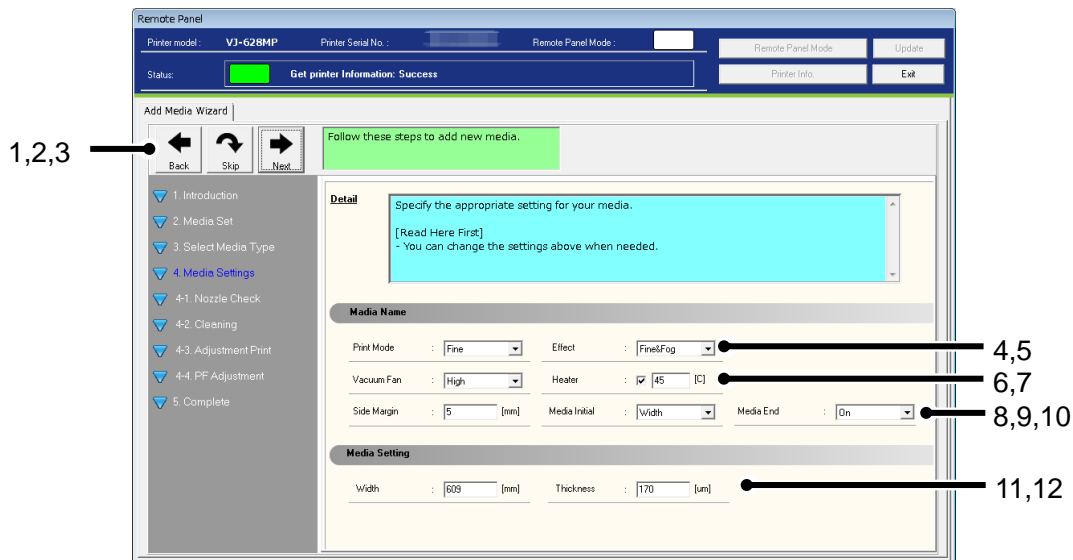

No.	Name	Description
1	Back	Go back to the previous menu.
2	Skip	Skip this menu to exit the wizard.
3	Next	Apply the media settings. Once clicked, go to the Nozzle Check menu.
4	Print Mode	Select the print mode.
5	Effect	Select the effect.
6	Vacuum Fan	Select the vacuum fan setting.
7	Heater	Specify the heater temperature.
8	Side Margin	Specify the side margin.
9	Media Initial	Select the media initialization setting.
10	Media End *1	Select the media end setting.
11	Width	Specify the media width.
12	Thickness	Specify the media thickness.

NOTE

- *1 This function is available for VJ-628MP.

4-2) Nozzle Check

After applying the media settings, check the print head performance to ensure the print quality.

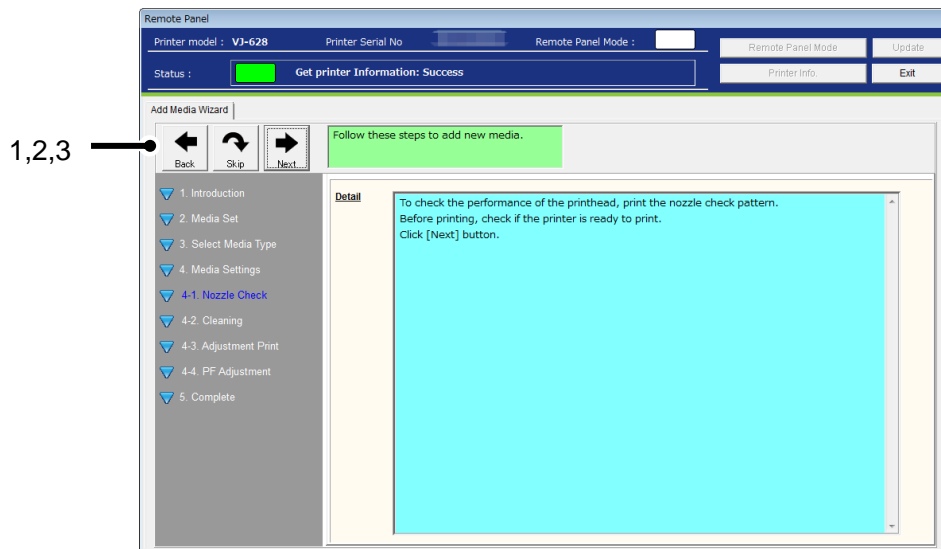

No.	Name	Description
1	Back	Go back to the previous menu.
2	Skip	Skip this menu to go to the Print Quality Adjustment menu.
3	Next	Check if the printer is ready for print.

4-3) Check the printer status

Check if the printer is ready for print.

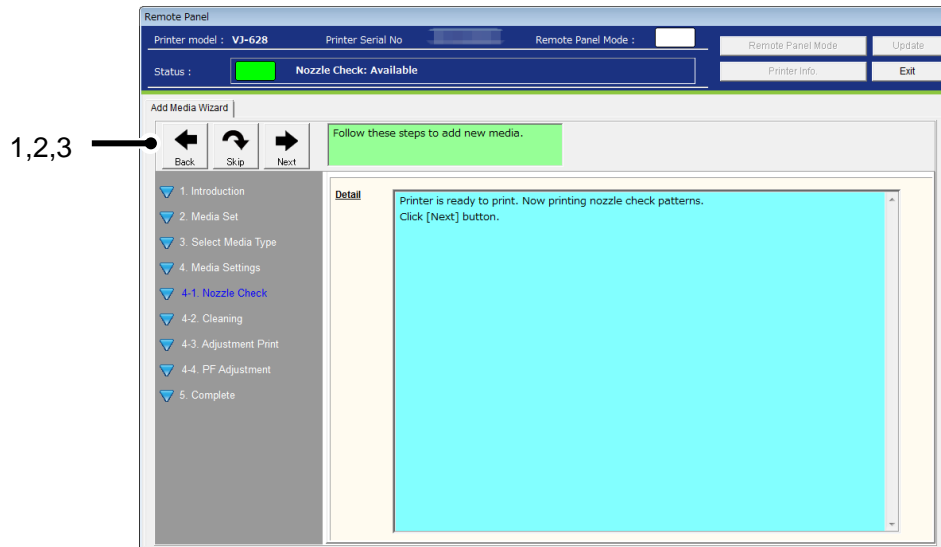

No.	Name	Description
1	Back	Go back to the previous menu.
2	Skip	Skip this menu to go to the Print Quality Adjustment menu.
3	Next	Requests the printer to print the nozzle check patterns.

NOTE

- If the printer is not ready for print, the nozzle check patterns cannot be printed.
Check the printer status before printing.

4-4) Nozzle Check

Check the print head performance from the printed results.

If any missing line is found, perform the cleaning.

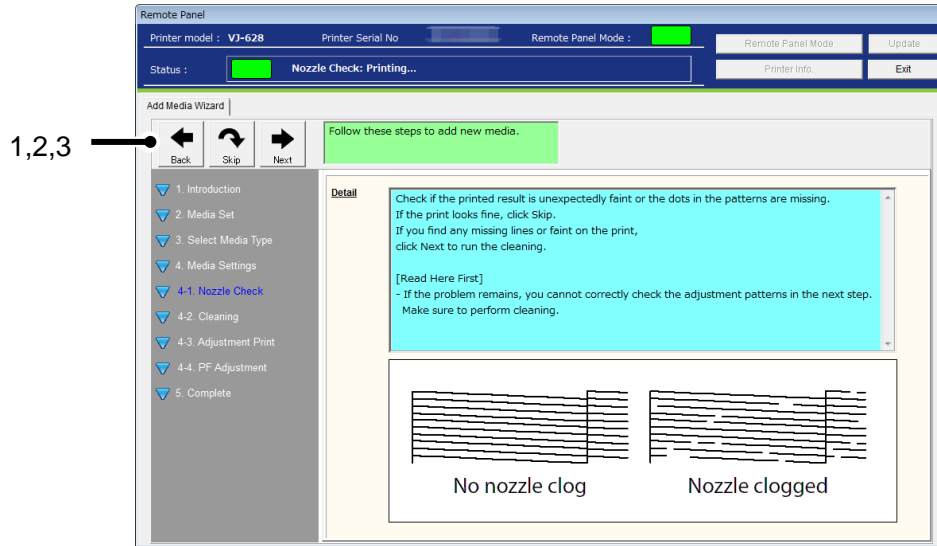

No.	Name	Description
1	Back	Go back to the previous menu.
2	Skip	Skip this menu to go to the Print Quality Adjustment menu.
3	Next	Proceed to the next setting.

4-5) Cleaning

Perform the cleaning after nozzle check, if necessary.

When the cleaning is started, go back to the nozzle check menu. Check the print head performance again.

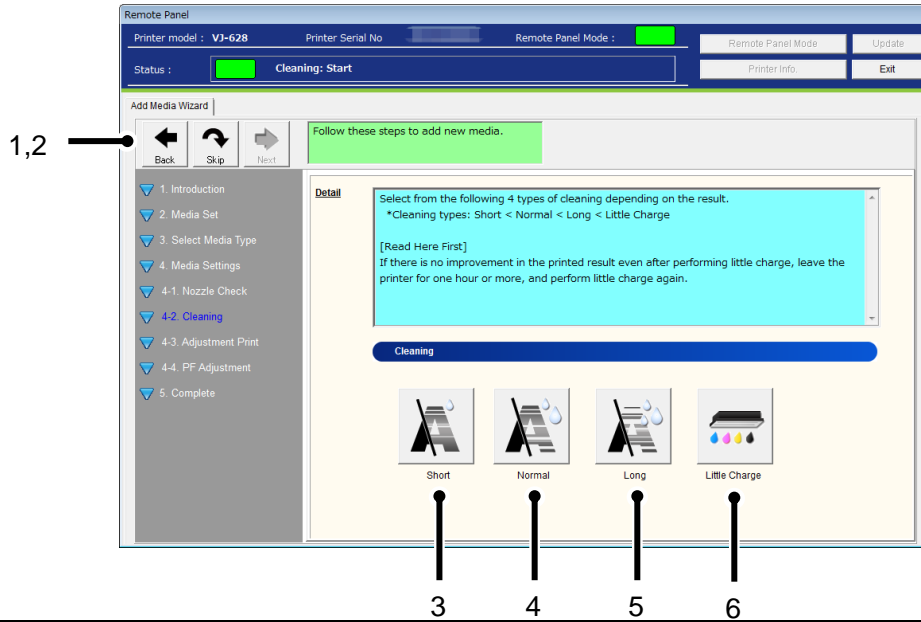

No.	Name	Description
1	Back	Go back to the previous menu.
2	Skip	Skip this menu to go to the Print Quality Adjustment menu.
3	Short Cleaning	Discharges smaller amount of ink compared to "Normal". When the short cleaning is started, go back to the nozzle check menu.
4	Normal Cleaning	Select this mode normally. When the normal cleaning is started, go back to the nozzle check menu.
5	Long Cleaning	Discharges larger amount of ink compare to "Normal". When the long cleaning is started, go back to the nozzle check menu.
6	Little Charge	Refills a small amount of ink. When the little charge is started, go back to the nozzle check menu.

4-6) Adjustment Print Wizard

Follow the steps to adjust the print quality.

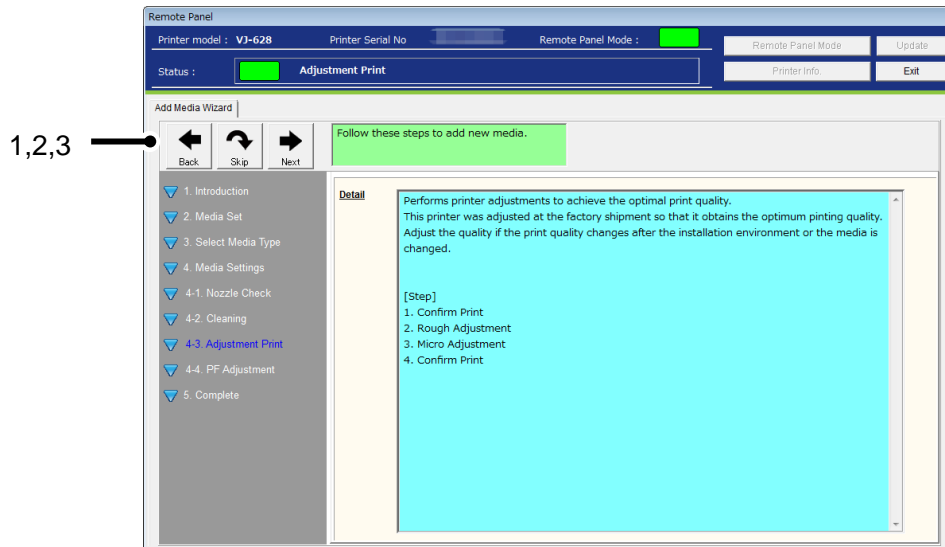

No.	Name	Description
1	Back	Go back to the previous menu.
2	Skip	Skip this menu to exit the wizard.
3	Next	Proceed to the next setting.

4-6-1) Media Thickness

Enter the media thickness.

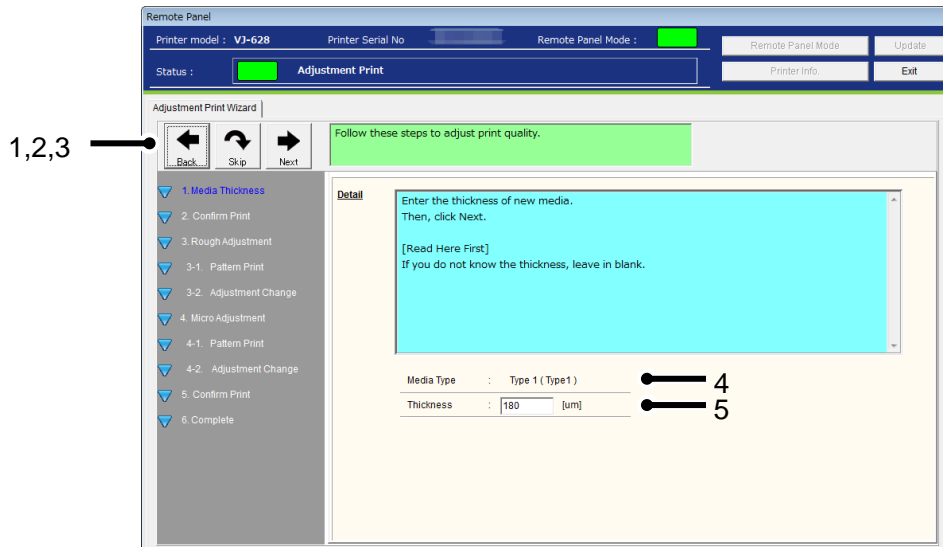

No.	Name	Description
1	Back	Go back to the previous menu.
2	Skip	Skip this menu and go to the Confirm Print menu.
3	Next	Apply the media thickness setting. Once clicked, go to the Confirm Print menu.
4	Media Type	Displays the media type to be added.
5	Thickness	Enter the media thickness in micrometer.

4-6-2) Confirm Print

Prints the confirm patterns to check the current print quality.

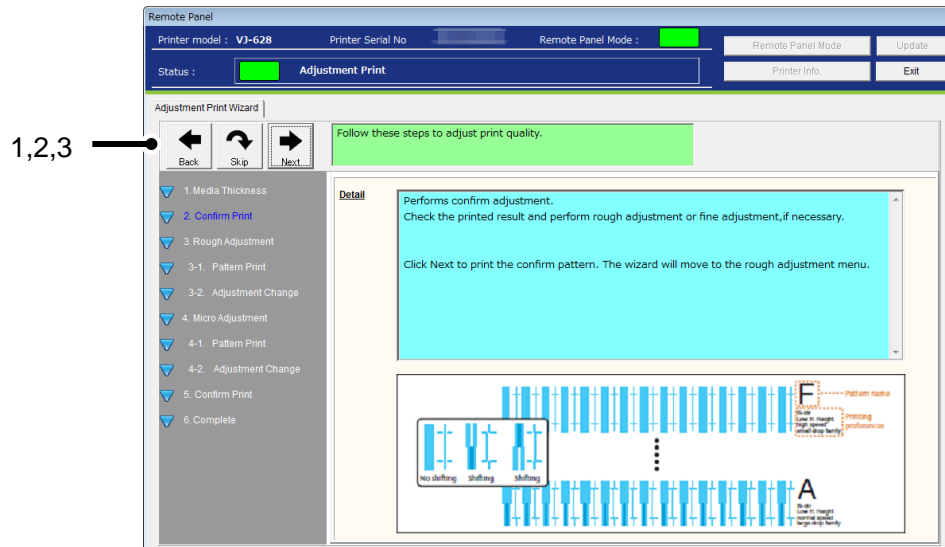

No.	Name	Description
1	Back	Go back to the previous menu.
2	Skip	Skip this menu and go to the Rough Adjustment menu.
3	Next	Prints the confirm patterns. Once clicked, go to the Rough Adjustment menu.

4-6-3) Rough Adjustment

Performs the rough adjustment.

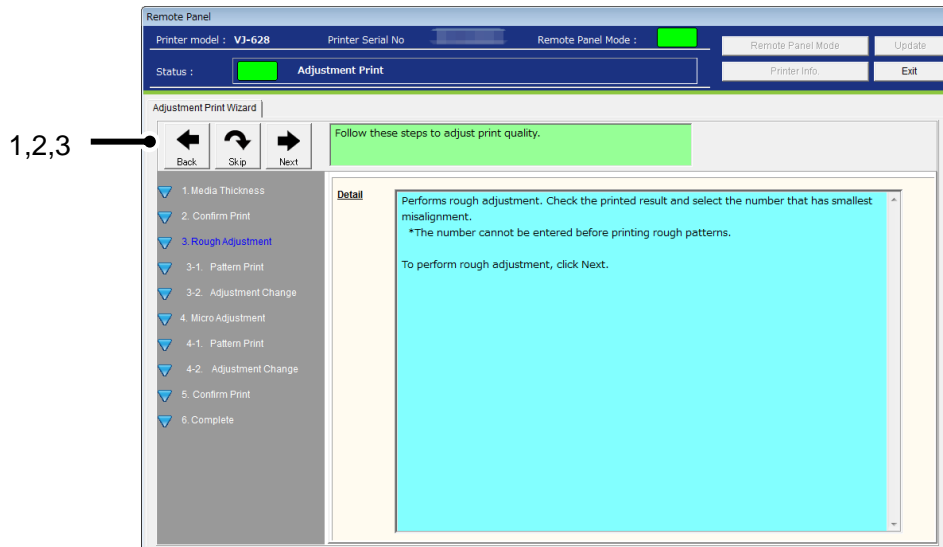

No.	Name	Description
1	Back	Go back to the previous menu.
2	Skip	Skip this menu to go to the Micro Adjustment menu.
3	Next	Proceed to the next setting.

4-6-4) Rough Adjustment Print

Prints the rough adjustment patterns.

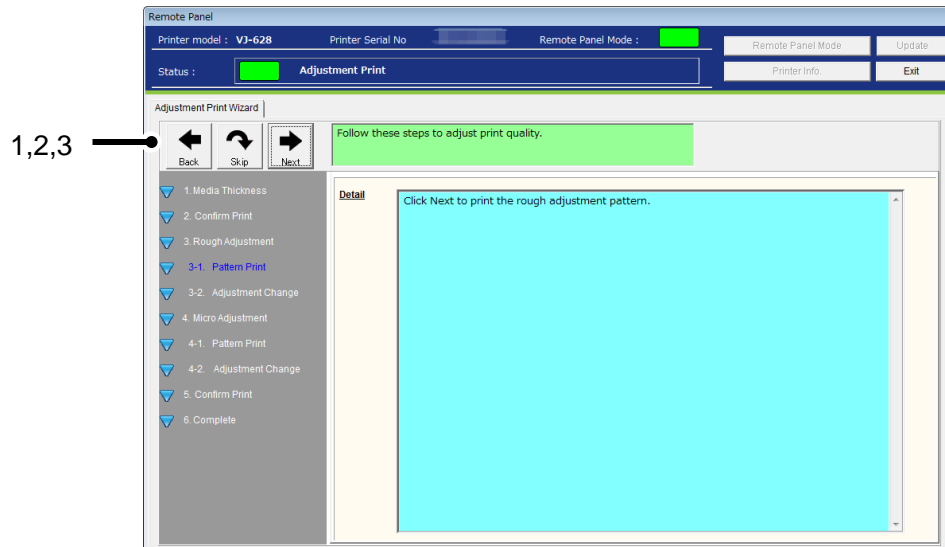

No.	Name	Description
1	Back	Go back to the previous menu.
2	Skip	Skip this menu to go to the Micro Adjustment menu.
3	Next	Prints the rough adjustment patterns. Once clicked, go to the Rough Adjustment Change menu.

4-6-5) Rough Adjustment Change

Enter the rough adjustment value after checking the printed results.

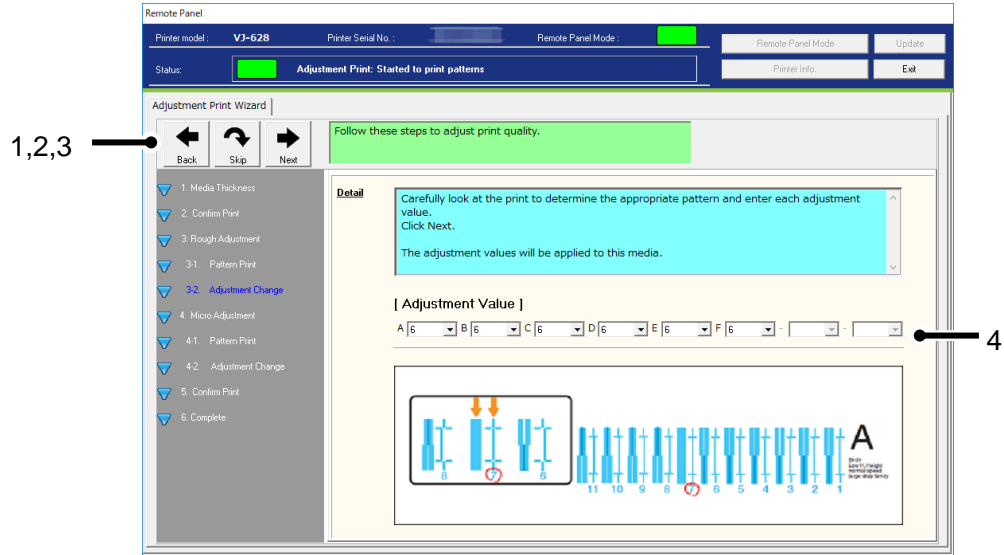

No.	Name	Description
1	Back	Go back to the previous menu.
2	Skip	Skip this menu and go to the micro adjustment menu.
3	Next	Apply the rough adjustment value change. Once clicked, go to the Micro Adjustment menu.
4	Adjustment Value	Enter each adjustment value.

NOTE

- The available pattern and adjustment range changes depending on the printer model and ink type.

4-6-6) Micro Adjustment

Performs the micro adjustment.

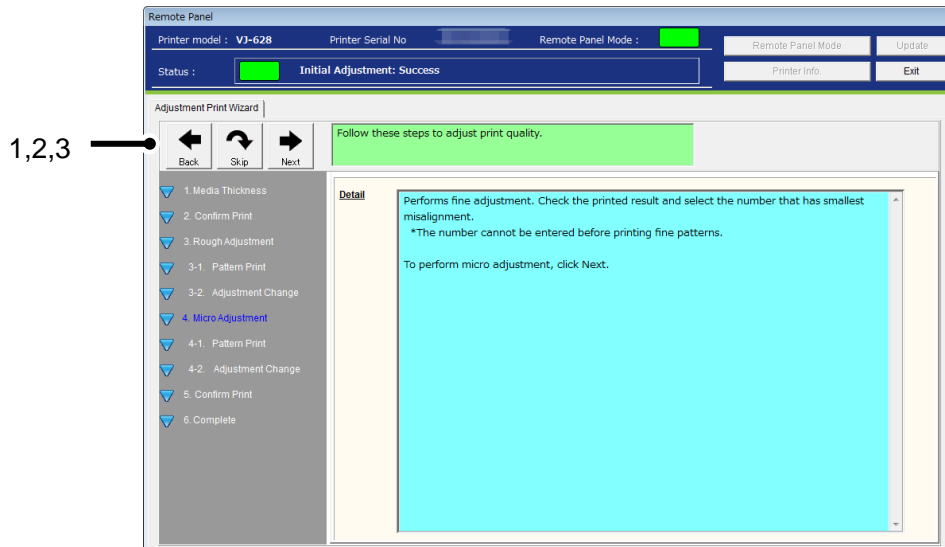

No.	Name	Description
1	Back	Go back to the previous menu.
2	Skip	Skip this menu to exit the wizard.
3	Next	Proceed to the next setting.

4-6-7) Micro Adjustment Print

Prints the micro adjustment patterns.

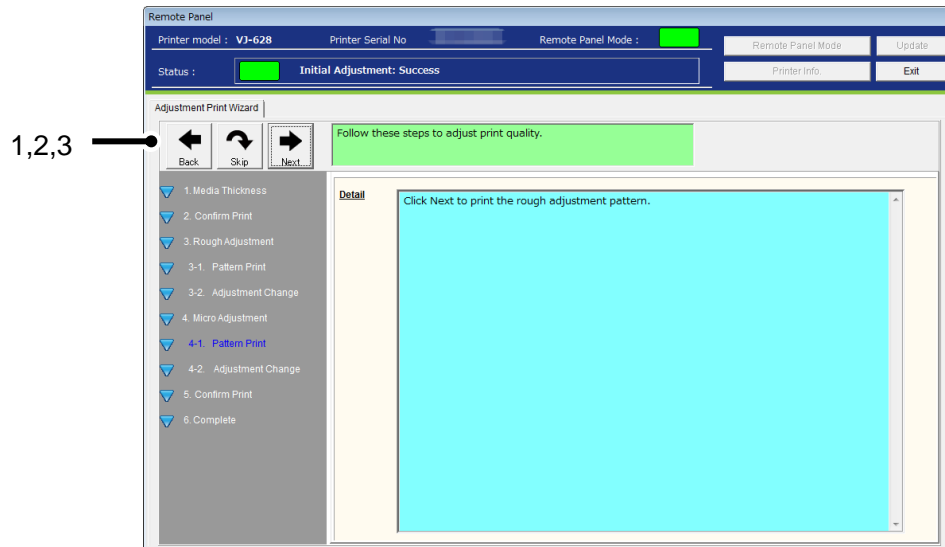

No.	Name	Description
1	Back	Go back to the previous menu.
2	Skip	Skip this menu to exit the wizard.
3	Next	Prints the micro adjustment patterns. Once clicked, go to the Micro Adjustment Change menu.

4-6-8) Micro Adjustment Set

Enter the micro adjustment value after checking the printed results.

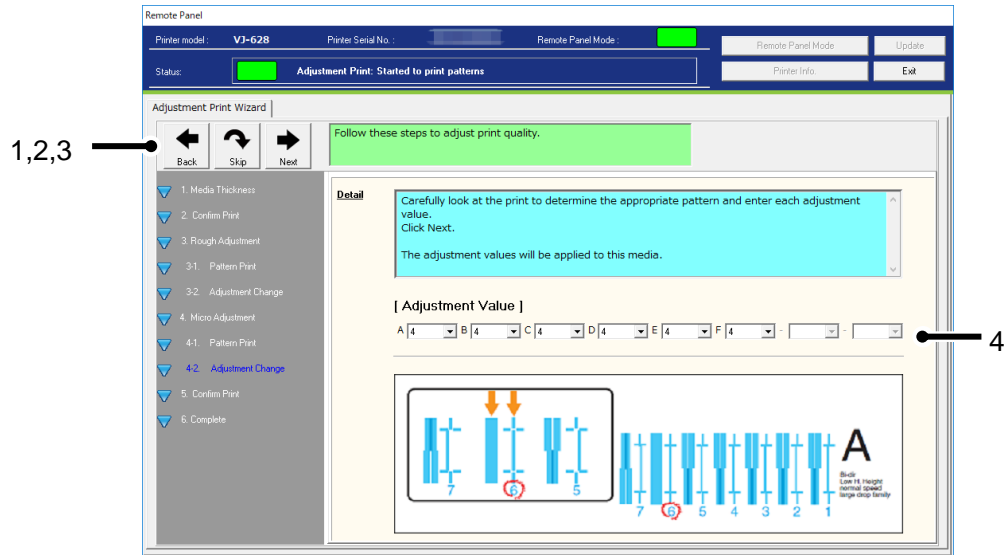

No.	Name	Description
1	Back	Go back to the previous menu.
2	Skip	Skip this menu to exit the wizard.
3	Next	Apply the micro adjustment value. Once clicked, go to the Confirm Print menu.
4	Adjustment Value	Enter each adjustment value.

NOTE

- The available pattern and adjustment range changes depending on the printer model and ink type.

4-6-9) Confirm Print

Prints the confirm patterns to check the adjustment results.

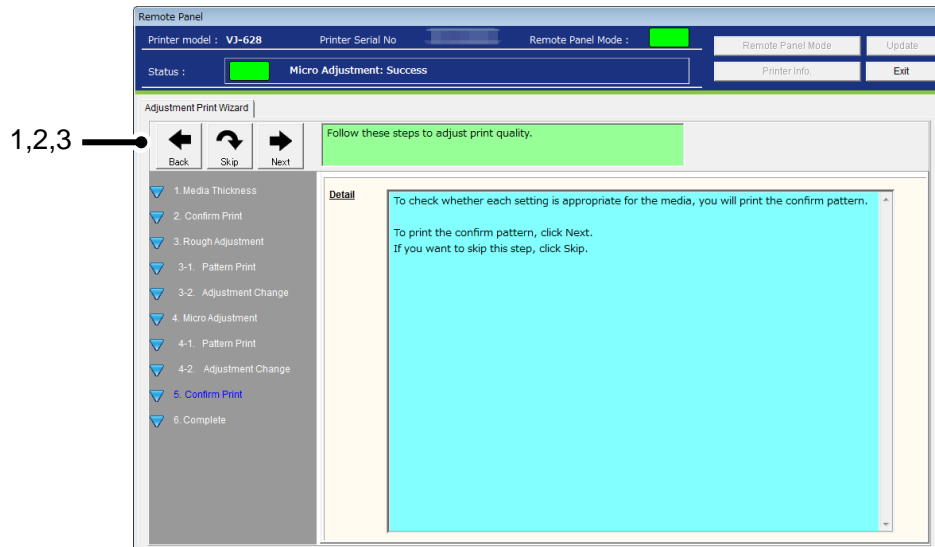

No.	Name	Description
1	Back	Go back to the previous menu.
2	Skip	Skip this menu to exit the wizard.
3	Next	Prints the confirm patterns.

4-6-10) Check the Printed Result

Check the printed results and re-perform the adjustment if necessary.

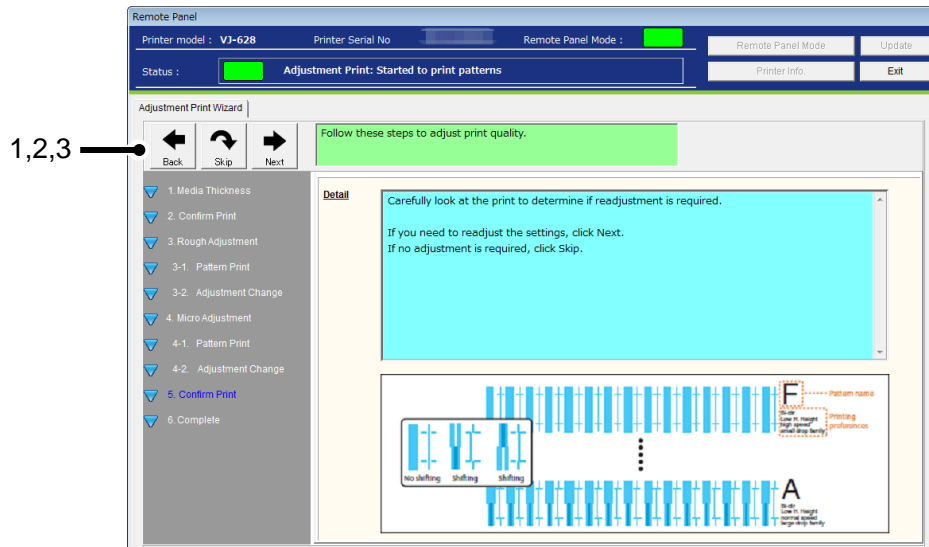

No.	Name	Description
1	Back	Go back to the previous menu.
2	Skip	Skip this menu to exit the wizard.
3	Next	Go back to the Micro Adjustment menu for readjustment.

4-6-11) **Complete**

Exit the Print Quality Adjustment wizard.

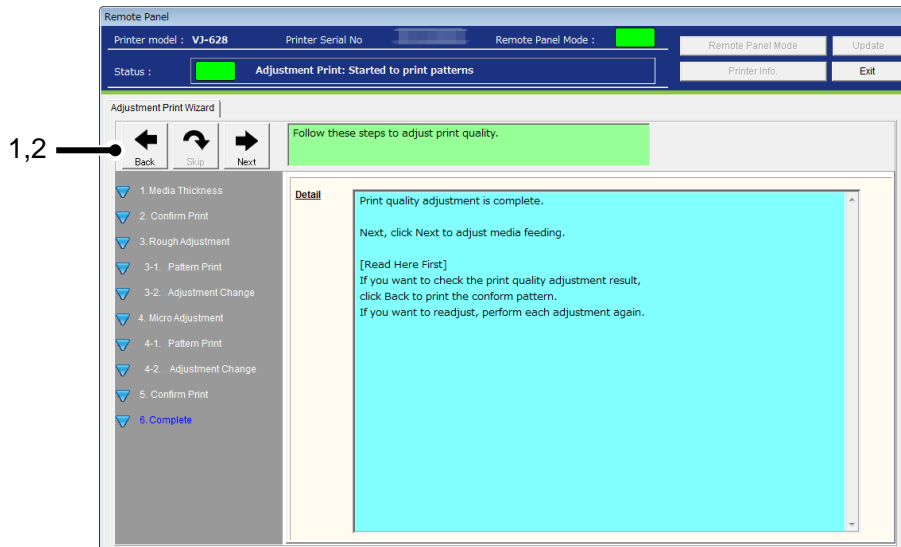

No.	Name	Description
1	Back	Go back to the previous menu.
2	Next	Proceed to the next setting.

4-7) Media Feed Adjustment

The media feeding length changes depending on the media type and it may affect the print quality. Perform the media feed adjustment to achieve the optimal print quality.

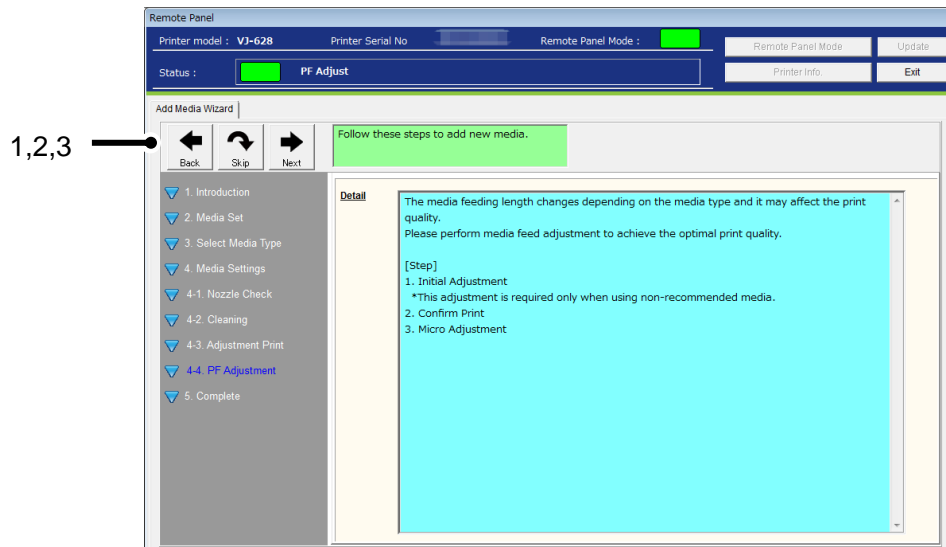

No.	Name	Description
1	Back	Go back to the previous menu.
2	Skip	Skip this menu to exit the wizard.
3	Next	Proceed to the next setting.

4-7-1) Initial Adjustment

Performs the initial adjustment.

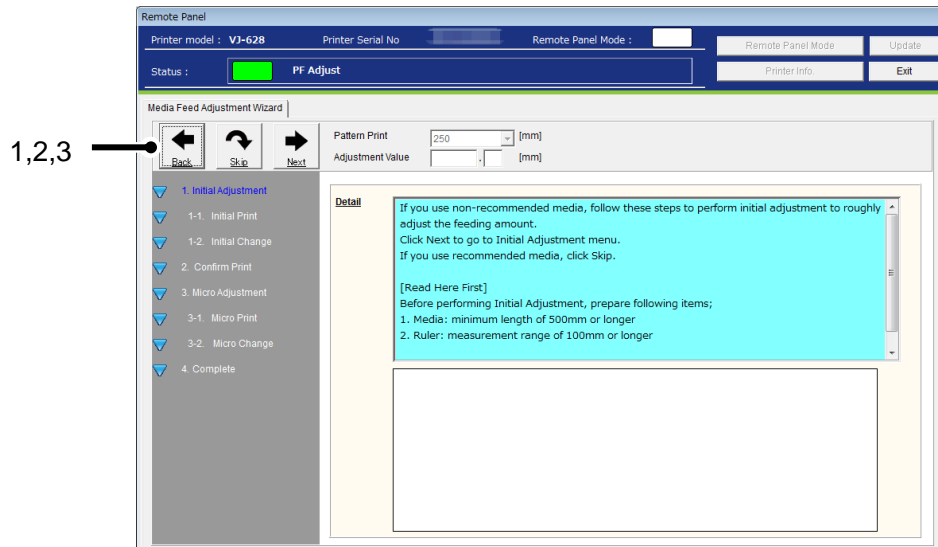

No.	Name	Description
1	Back	Go back to the previous menu.
2	Skip	Skip this menu to go to the “Micro Adjustment” menu.
3	Next	Proceed to the next setting.

NOTE

- The initial adjustment is not required for the recommended media. Click Skip to skip this menu.

4-7-2) Initial Print

Prints the initial print patterns.

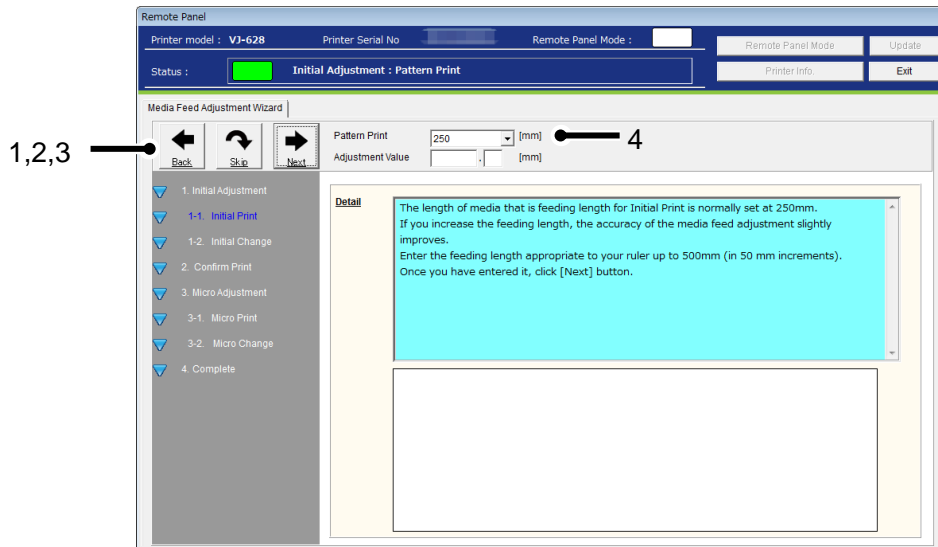

No.	Name	Description
1	Back	Go back to the previous menu.
2	Skip	Skip this menu to go to the Micro Adjustment menu.
3	Next	Prints the initial print patterns.
4	Pattern Print	Enter the feeding length by clicking the arrow key. Adjustment range: 100mm - 500mm (in increment of 50mm) *250mm is default value.

4-7-3) Initial Change

Set the adjustment value for the initial adjustment.

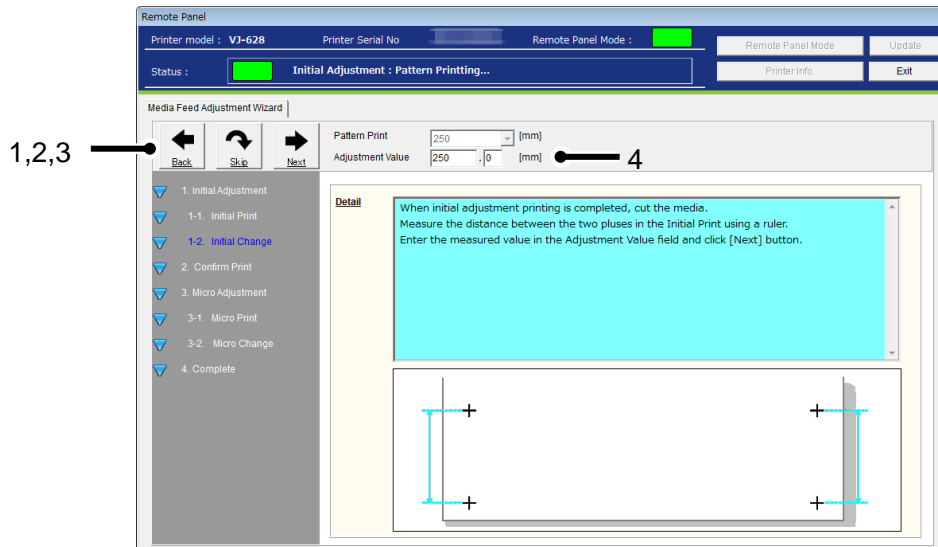

No.	Name	Description
1	Back	Go back to the previous menu.
2	Skip	Skip this menu to go to the Micro Adjustment menu.
3	Next	Sets the adjustment value for the initial adjustment to the printer.
4	Adjustment Value	Enter the adjustment value for the initial change. Adjustment range: ± 50 mm from the initial print length (in increment of 0.1mm) e.g.) if the initial print feeding length is set to 250mm: initial change range: 200.0mm – 300.0mm

4-7-4) Confirm Print

Prints the confirm print patterns to check the adjustment result.

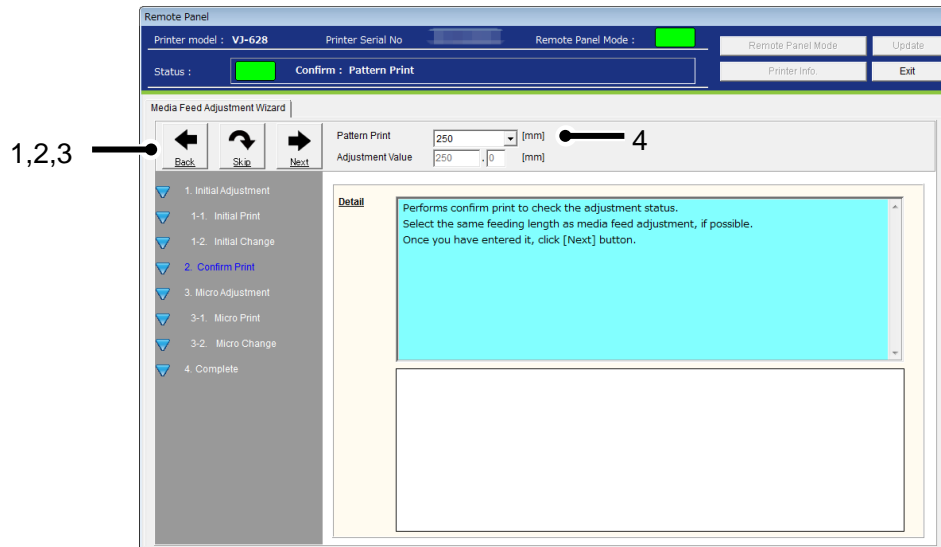

No.	Name	Description
1	Back	Go back to the previous menu.
2	Skip	Skip this menu and go to the Micro Adjustment menu.
3	Next	Prints the confirm print patterns.
4	Pattern Print	Enter the feeding length by clicking the arrow key. Adjustment range: 100mm - 500mm (in increment of 50mm) *250mm is default value.

4-7-5) Confirm

When initial adjustment printing is completed, cut the media.

Measure the distance between the two pluses using a ruler to confirm whether it matches the entered value.

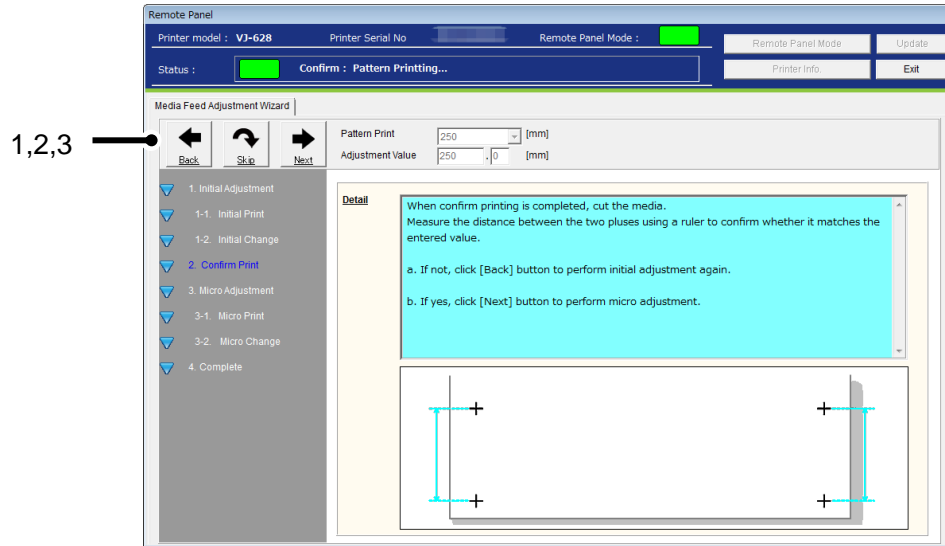

No.	Name	Description
1	Back	Go back to the previous menu.
2	Skip	Proceed to the next setting.
3	Next	

4-7-6) Micro Adjustment

Performs the micro adjustment for the media feeding adjustment.

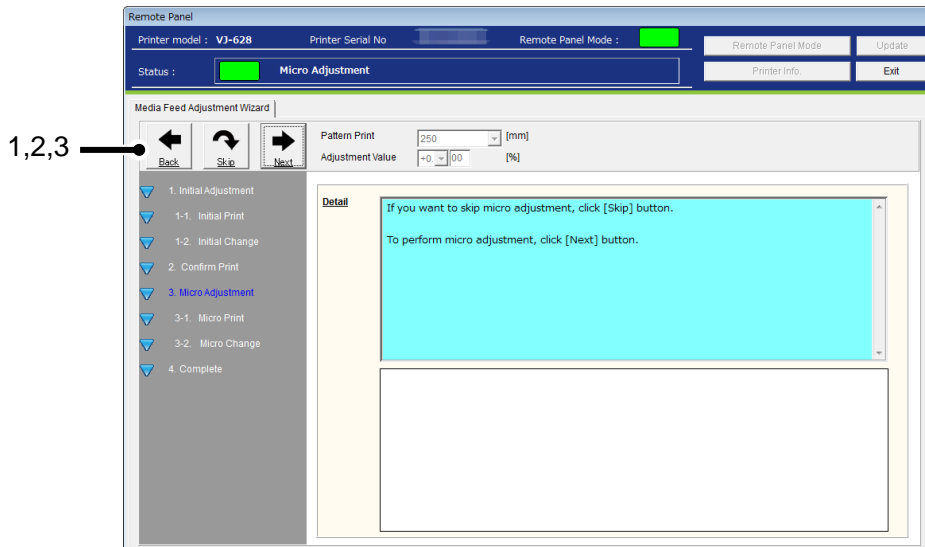

No.	Name	Description
1	Back	Go back to the previous menu.
2	Skip	Skip this menu to exit the wizard.
3	Next	Go to the "Micro Print" menu.

4-7-7) Micro Print

Prints the micro print patterns.

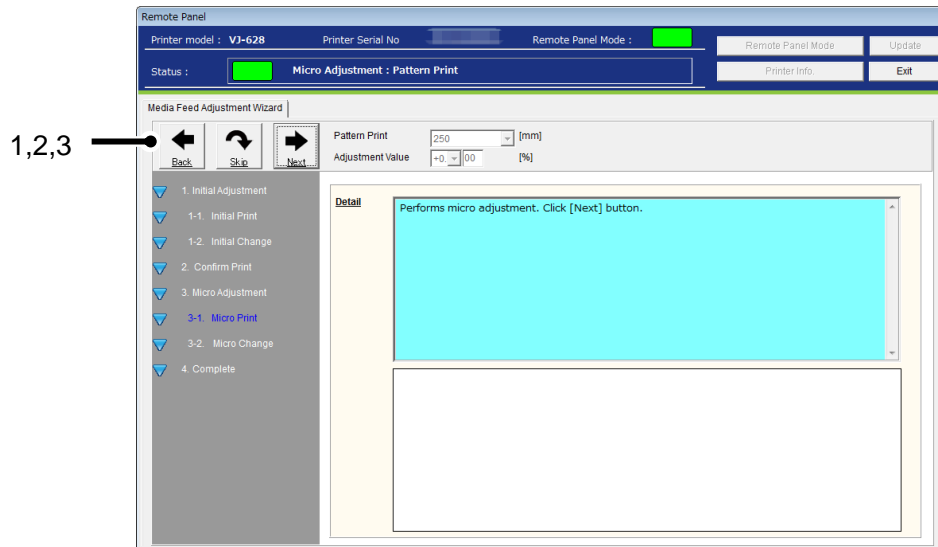

No.	Name	Description
1	Back	Go back to the previous menu.
2	Skip	Skip this menu to exit the wizard.
3	Next	Prints the micro adjustment patterns.

4-7-8) Micro Change

Set the adjustment value for the micro adjustment.

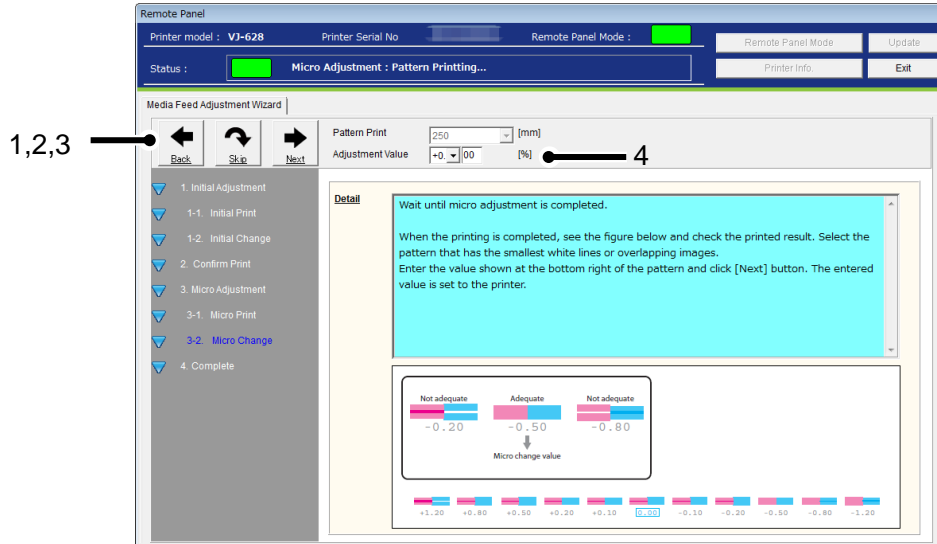

No.	Name	Description
1	Back	Go back to the previous menu.
2	Skip	Skip this menu to exit the wizard.
3	Next	Sets the adjustment value for the micro adjustment to the printer.
4	Adjustment Value	Enter the adjustment value for the micro adjustment. Adjustment range: $\pm 5.00\%$ (in increment of 0.01%)

4-7-9) Complete

Exit the Media Feeding Adjustment Wizard.

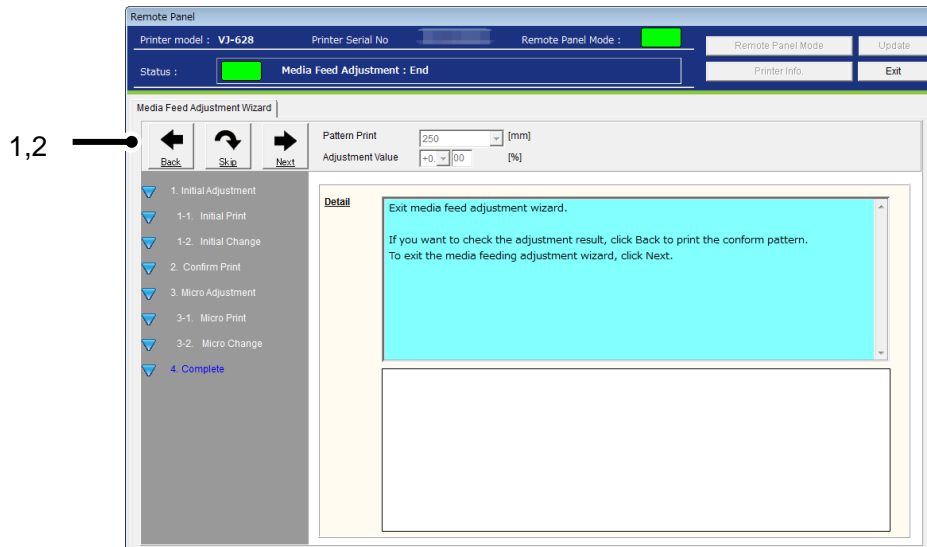

No.	Name	Description
1	Back	Go back to the previous menu.
2	Next	Go back to the Add Media wizard.

5) Complete

Exit the Add Media wizard.

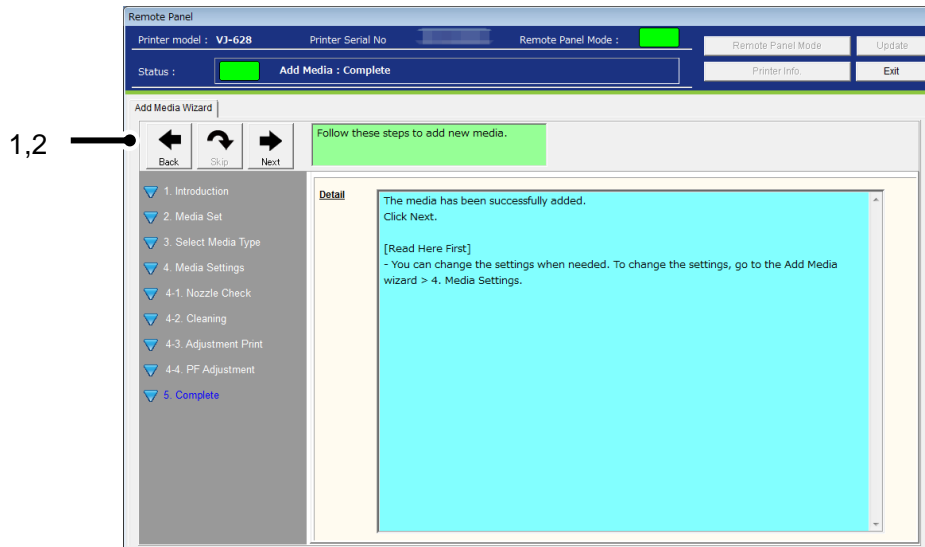

No.	Name	Description
1	Back	Go back to the previous menu.
2	Next	Go to the Media Setting tab.

13.1.4.2. Media Setting

Check and change the media setting currently loaded in the printer.

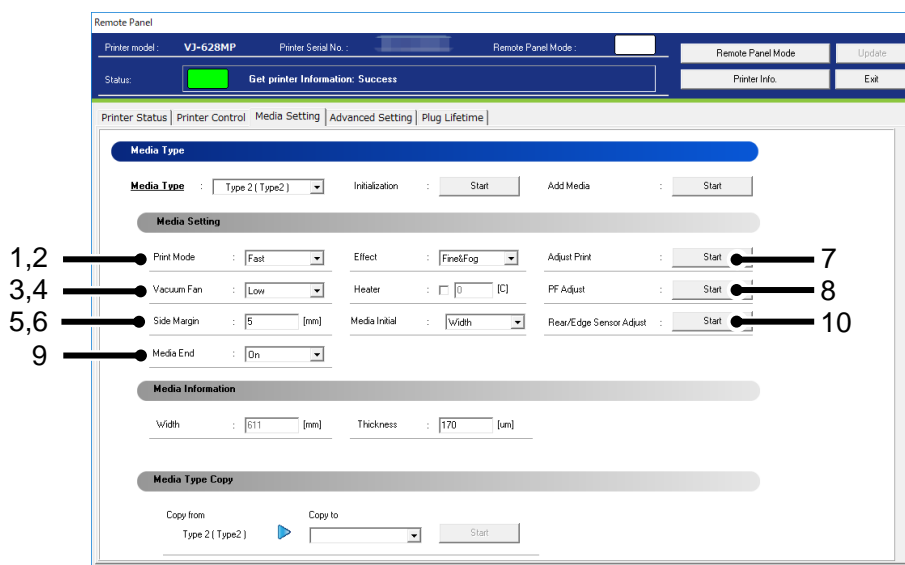

No.	Name	Description
1	Print Mode	Check and change the Print Mode of the media.
2	Effect	Check and change the Effect of the media.
3	Vacuum Fan	Check and change the vacuum fan of the media.
4	Heater	Check and change the heater temperature for the media.
5	Side Margin	Check and change the side margin setting of the media.
6	Media Initial	Check and change the media initialization setting of the media.
7	Adjust Print	Perform Bi-D adjustment for the media.
8	PF Adjust	Perform the paper feed adjustment of the media.
9	Media End *1	Check and change the media end setting of the media.
10	Rear/Edge Sensor Calibration *2	Calibrate the rear sensor and the edge sensor for the media being loaded.

NOTE

- To change the setting, change the values or settings and then click [Update] button.
 - Multiple settings can be changed at once.
 - If the previous version of F/W is installed, the settings may not be properly reflected. Make sure to install the latest F/W.
 - *1 This function is available for VJ-628MP.
 - *2 This function is available for VJ-628MP,VJ-628X.
-

(1) Adjust Print

Perform Bi-D adjustment for the media loaded in the printer.

1) Thickness

Specify the media thickness.

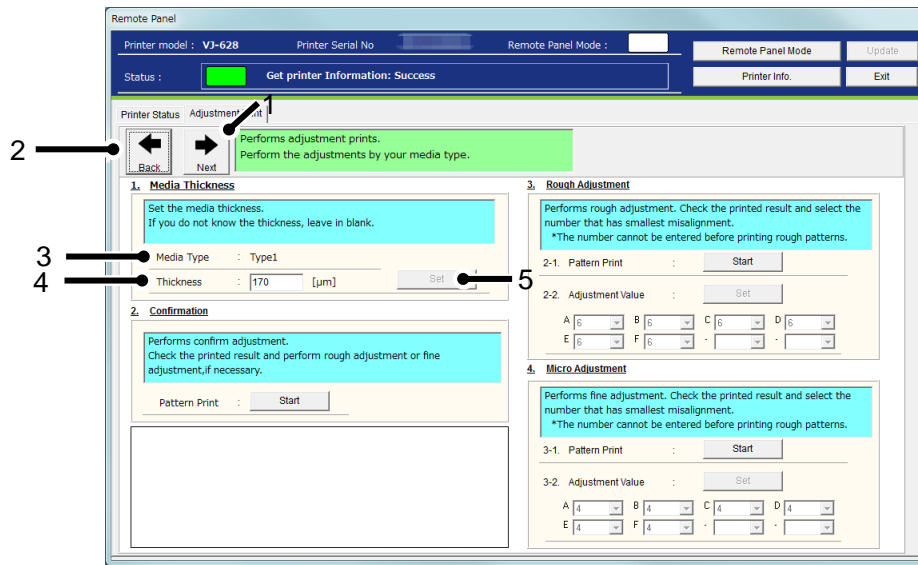

No.	Name	Description
1	Next	Go to the Media Setting Menu.
2	Back	Go back to the Media Setting Menu.
3	Media Type	The Media Type loaded in the printer is displayed.
4	Thickness	Enter the media thickness set in the printer.
5	Set	Set the media thickness to the printer.

2) Confirmation

Print the adjustment pattern in the current setting.

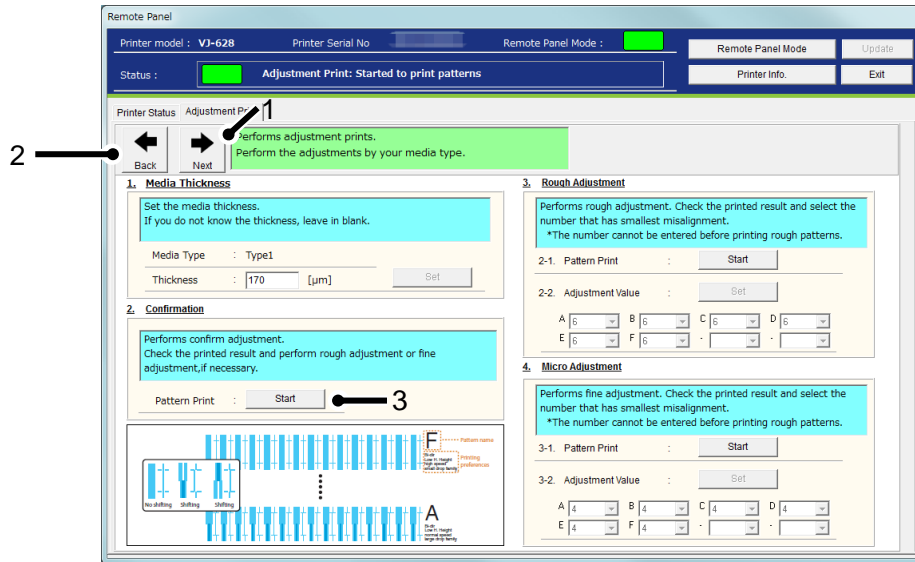

No.	Name	Description
1	Next	Go to the Media Setting Menu.
2	Back	Go back to the Media Setting Menu.
3	Start	Print the adjustment pattern in the current setting.

3) Rough Adjustment

Perform rough adjustment.

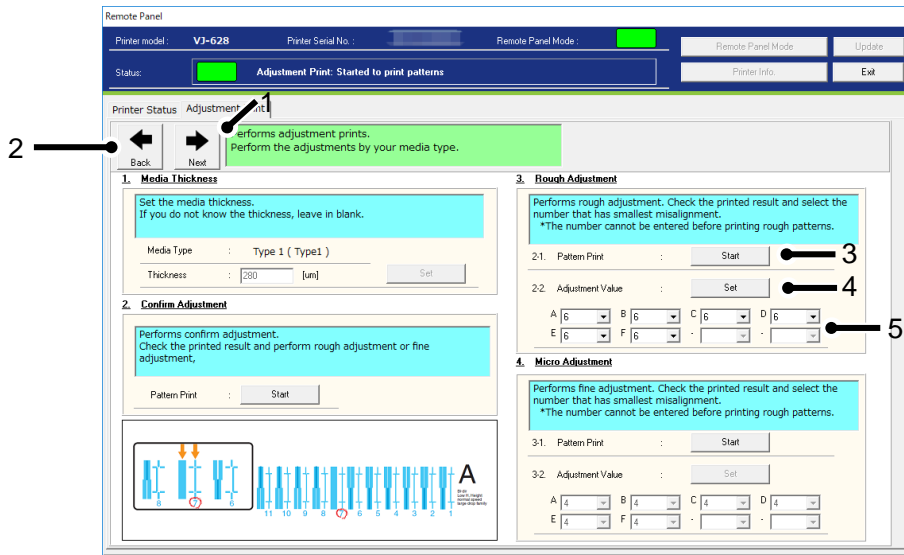

No.	Name	Description
1	Next	Go to the Media Setting Menu.
2	Back	Go back to the Media Setting Menu.
3	Start	Print the rough adjustment pattern.
4	Set	Set the adjustment value to the printer after the value change.
5	Adjustment Value	Change each adjustment value. *Adjustment patterns and adjustment range vary depending on the printer or ink type you use.

4) Micro Adjustment

Perform micro adjustment.

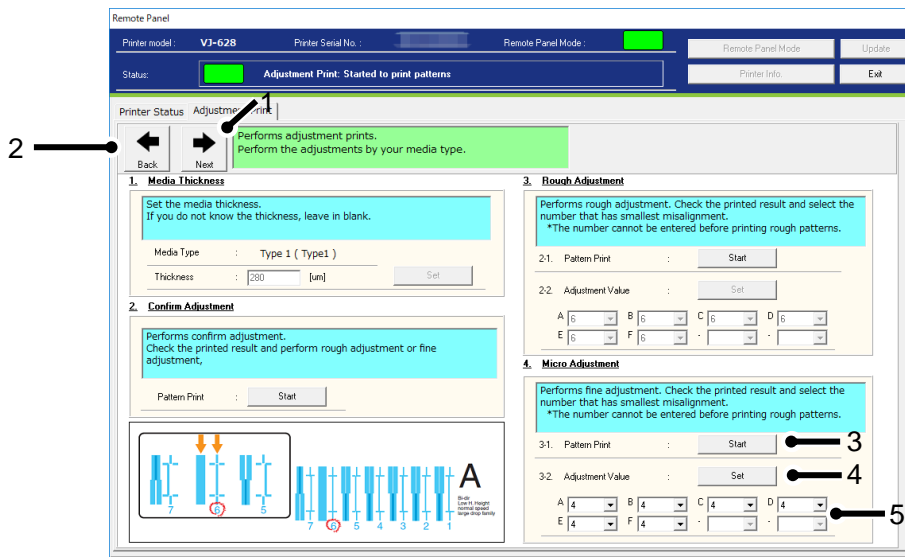

No.	Name	Description
1	Next	Go to the Media Setting Menu.
2	Back	Go back to the Media Setting Menu.
3	Start	Print the rough adjustment pattern.
4	Set	Set the adjustment value to the printer after the value change.
5	Adjustment Value	Change each adjustment value. *Adjustment patterns and adjustment range vary depending on the printer or ink type you use.

(2) PF Adjust

Perform the paper feed adjustment.

1) Initial Adjust

Performs initial adjustment.

Click [Start] button to print initial adjustment pattern and measure the distance between the printed two pluses (+)

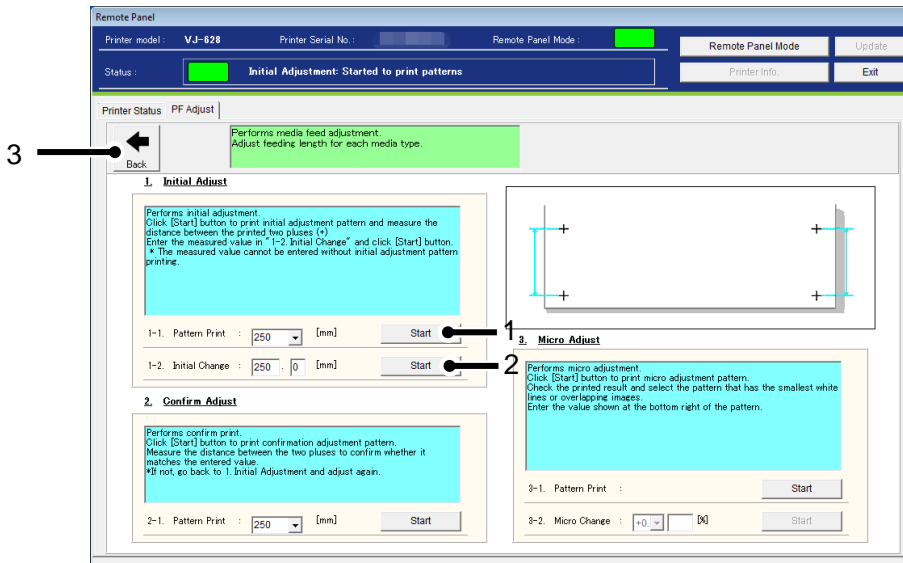

No.	Name	Description
1	Pattern Print - Start	Print the initial PF adjustment pattern. Pattern length : 100 [mm] ~ < 250 [mm] > ~ 500 [mm] (in increments of 50 [mm])
2	Initial Change - Start	Set the initial PF adjustment value to the printer. Adjustable range : ±50.0 [mm] from the initial PF adjustment pattern (in increments of 0.1[mm]). e.g.) If the initial PF adjustment pattern is set to 250[mm], the adjustable range will be 200 [mm] ~ 300 [mm].
3	Back	Go back to the Media Setting Menu.

2) Confirm Adjust

Performs confirm print.

Click [Start] button to print confirmation adjustment pattern.

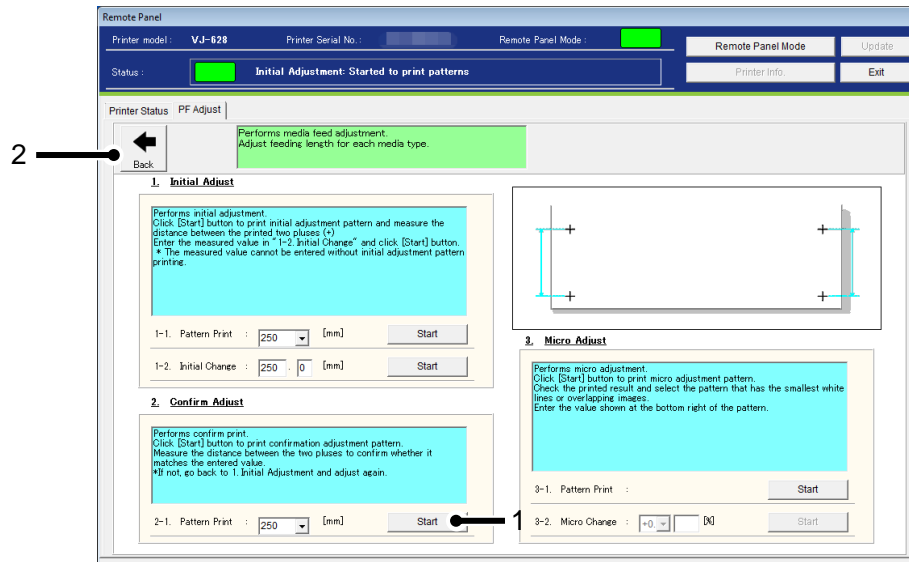

No.	Name	Description
1	Pattern Print - Start	Print the PF adjustment pattern with current setting. Pattern length : 100 [mm] ~ < 250 [mm] ~ 500 [mm] (in increments of 50 [mm])
2	Back	Go back to the Media Setting Menu.

3) Micro Adjust

Performs micro adjustment.

Click [Start] button to print micro adjustment pattern.

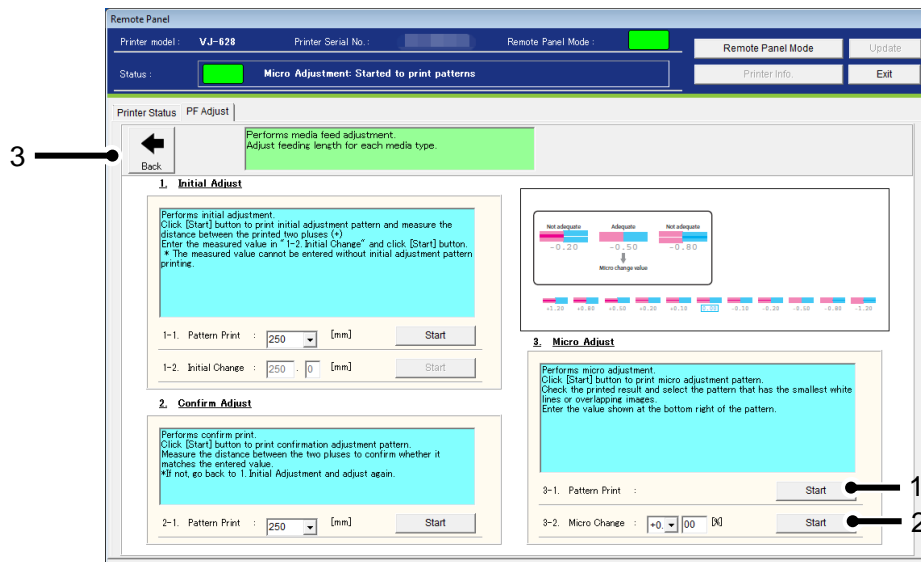

No.	Name	Description
1	Pattern Print - Start	Print the PF adjustment pattern with current setting.
2	Micro Change - Start	Set the micro adjustment value to the printer. Adjustable range: ± 5.00 [%] from the initial PF adjustment pattern (in increments of 0.01[%]).
3	Back	Go back to the Media Setting Menu.

(3)Rear/Edge Sensor Calibration

Calibrate the rear and edge sensors.

1)Load media

Load a media to be calibrated in the printer.

Once loaded, click [Next]. The printer will begin the calibration.

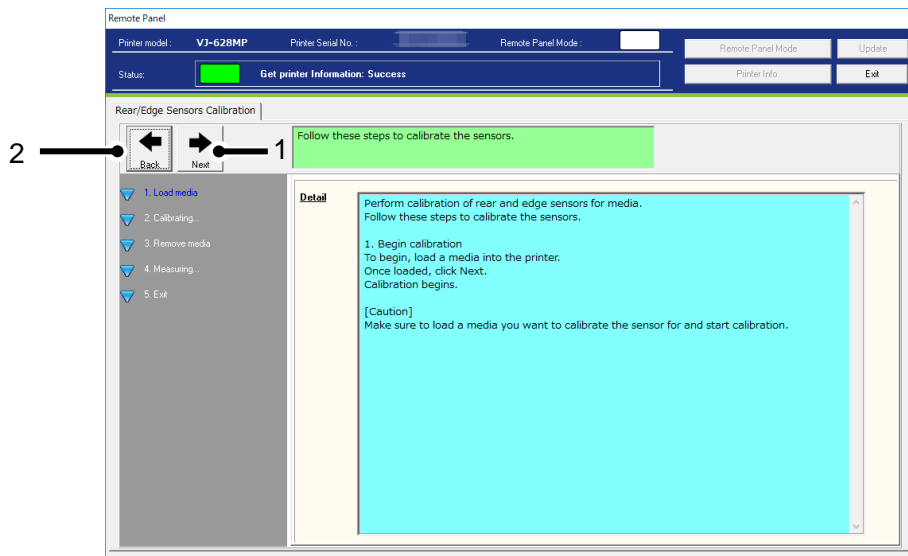

No.	Name	Description
1	Next	Start the calibration.
2	Back	Go back to the Media Setting Menu.

NOTE

- Make sure that the media to be calibrated is loaded in the printer before starting calibration.

2) Calibrating

Calibration is being performed. Please wait until completed.

If failed, the calibration will end and the display will go to 5).

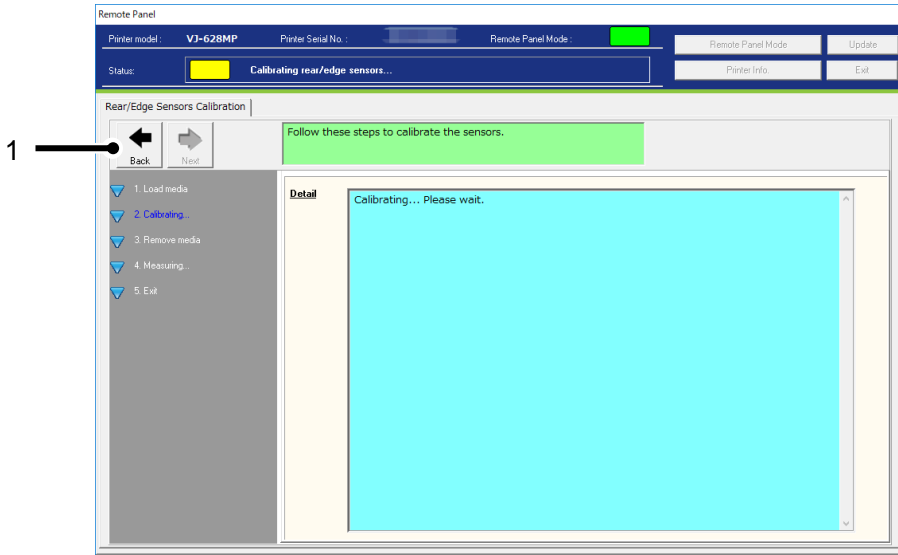

No.	Name	Description
1	Back	Go back to the Media Setting Menu. The printer processing will be interrupted. To resume, select "Rear/Edge Sensor Calibration" in the Media Setting menu.

If an error occurred, calibration will stop and the details of error will be displayed.

To continue the calibration, clear the error.

Calibration may fail depending on the error timing.

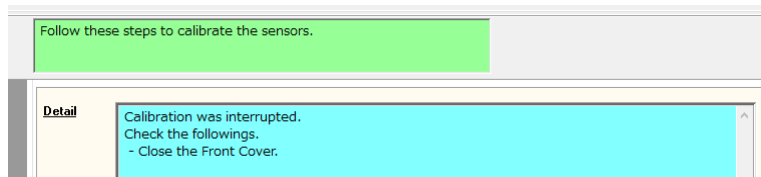

NOTE

- The following problems can lead to calibration failure:
 - An error occurred during the calibration.
 - Unable to detect media.
 - Printer failure.

Please contact the local MUTOH dealer.

3) Remove Media

To start measurement, remove the media.

Once removed, click [Next]. The printer will begin the measurement.

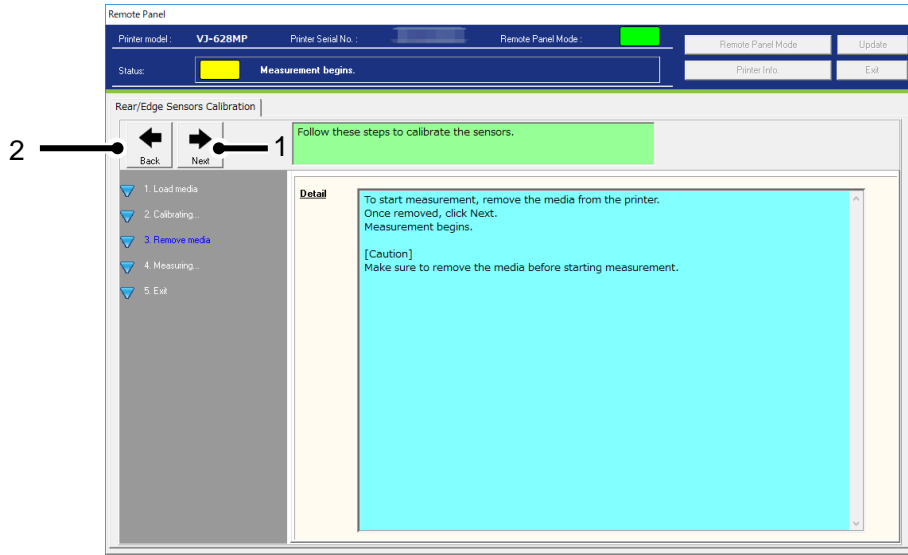

No.	Name	Description
1	Next	Start measuring.
2	Back	Go back to the Media Setting Menu. The printer processing will be interrupted. To resume, select "Rear/Edge Sensor Calibration" in the Media Setting menu.

NOTE

Make sure to remove the media before start measurement.

4) Measuring

Measurement is being performed. Please wait until completed.

If failed, the measurement will end and the display will go to 5).

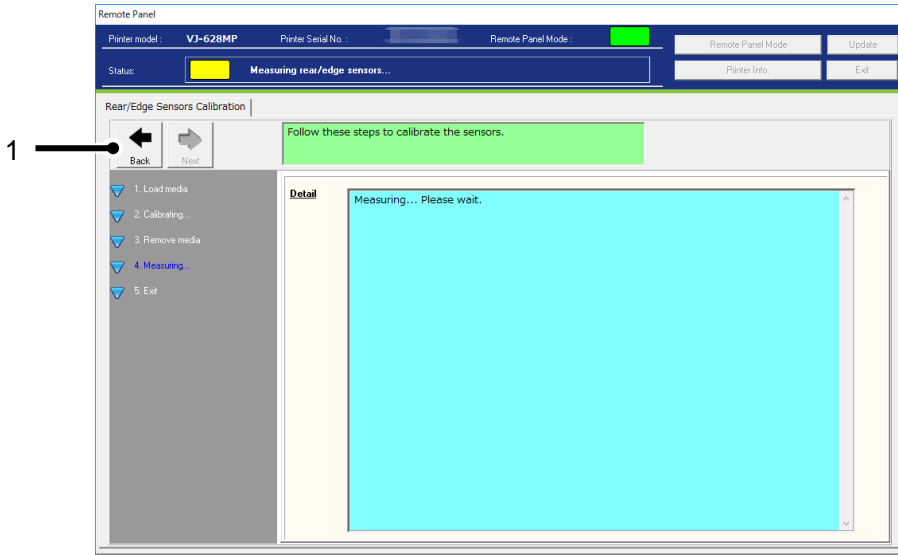

No.	Name	Description
1	Back	Go back to the Media Setting Menu.

If an error occurred, measurement will stop and the details of error will be displayed.

To continue the measurement, clear the error.

Measurement may fail depending on the error timing.

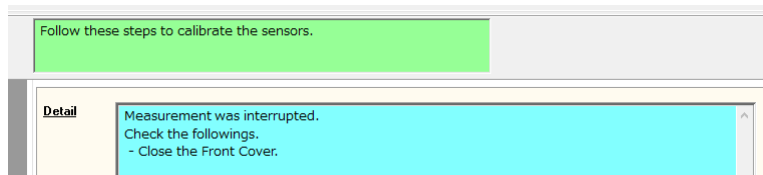

NOTE

- The following problems can lead to measurement failure:
 - An error occurred during measurement.
 - Printer failure.
- Please contact the local MUTOH dealer.

5) Exit

The measurement process is completed.

Click [Next] to go back to the Media Setting menu.

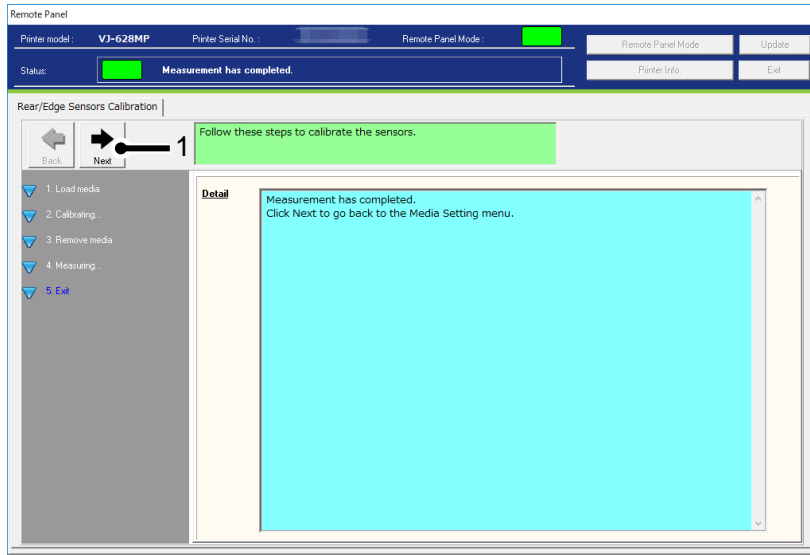

No.	Name	Description
1	Back	Go back to the Media Setting Menu.

13.1.4.3. Media Information

Check and change the width and thickness of the media set in the printer.

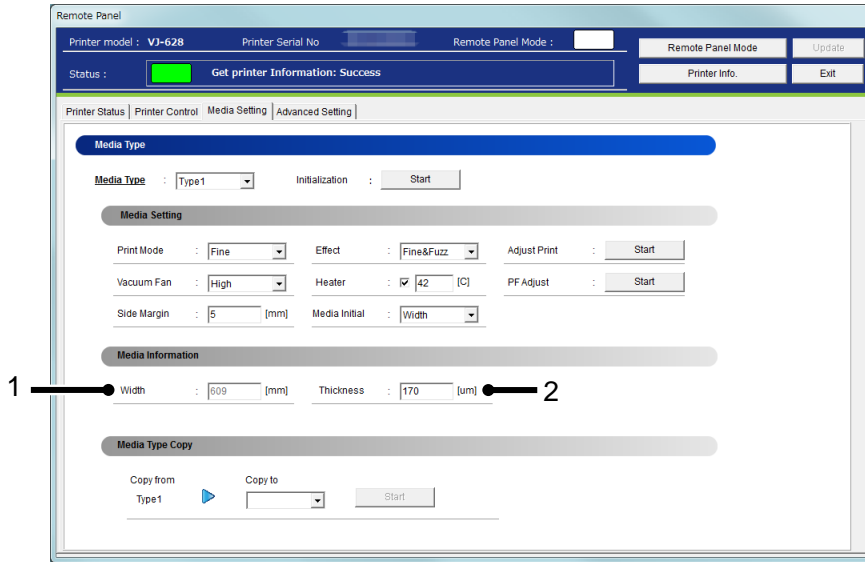

No.	Name	Description
1	Width	Check and change the width of media. When the “Media Initial” is set to “Off”, the “Media Width” can be changed. When the “Media Initial” is set to other than “Off”, the media initialization will be performed and the media width will be displayed on this menu.
2	Thickness	Check and change the thickness of media. After the adjustment, if you enter the different media thickness, the printer performs the automatic adjustment according to the entered value.

NOTE

- The automatic adjustment determines the approximation. If you want to perform exactly accurate adjustment, the additional adjustment should be required.
- If you are unsure of the media thickness, but the adjustment print can be performed without the thickness entry.
- To change the setting, change the values or settings and then click [Update] button.
- Multiple settings can be changed at once.

13.1.4.4. Media Type Copy

The selected user type settings can be copied to other user type.

The settings which can be copied are as follows:

Print Mode / Effect / set values for Adjust Print /

PF Adjustment values (initial feeding length/initial adjustment value/micro adjustment value) /

Heater / Vacuum Fan / Media Thickness / Media Setting

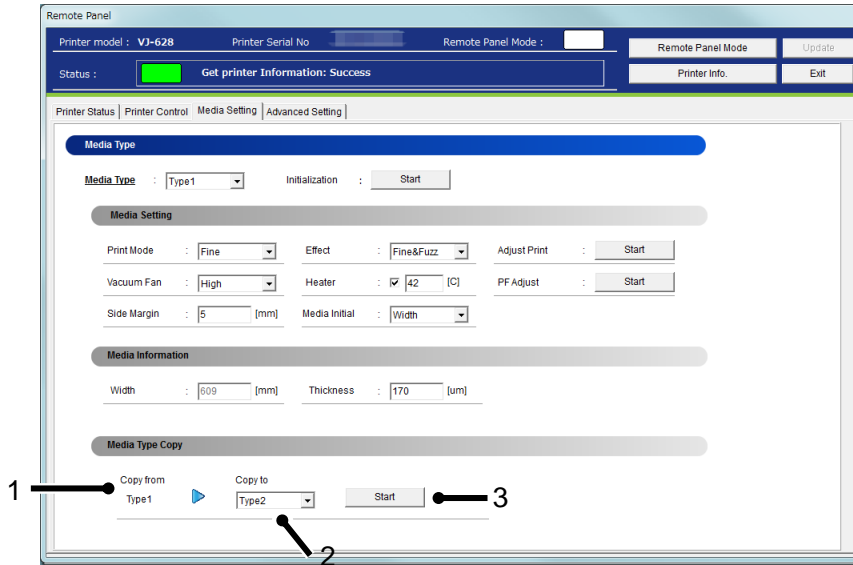

No.	Name	Description
1	Copy from	The selected Media Type is displayed.
2	Copy to	Select a Media Type that you want to copy to. All the Media Types other than the source Media Type can be selected. e.g.: If "User Type 1" is selected, the available copy destination will be User Type 2-10 or ALL.
3	Start	Start copying the setting.

NOTE

- Once the setting of copy destination is changed, it cannot restore to the original setting.

13.1.5 Advanced Setting

Check and change the advanced setting set in the printer.

From this menu, user can check the initial printer settings, and initialize the each setting to factory default.

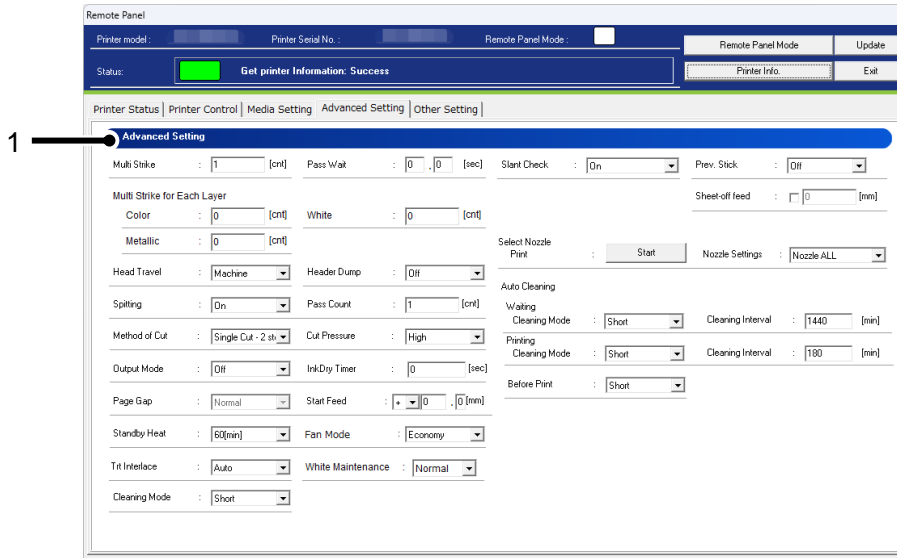

No.	Name	Description
1	Advanced Setting	Check and change the advanced setting set in the printer.

13.1.5.1. Advanced Setting

Check and change the advanced setting set in the printer.

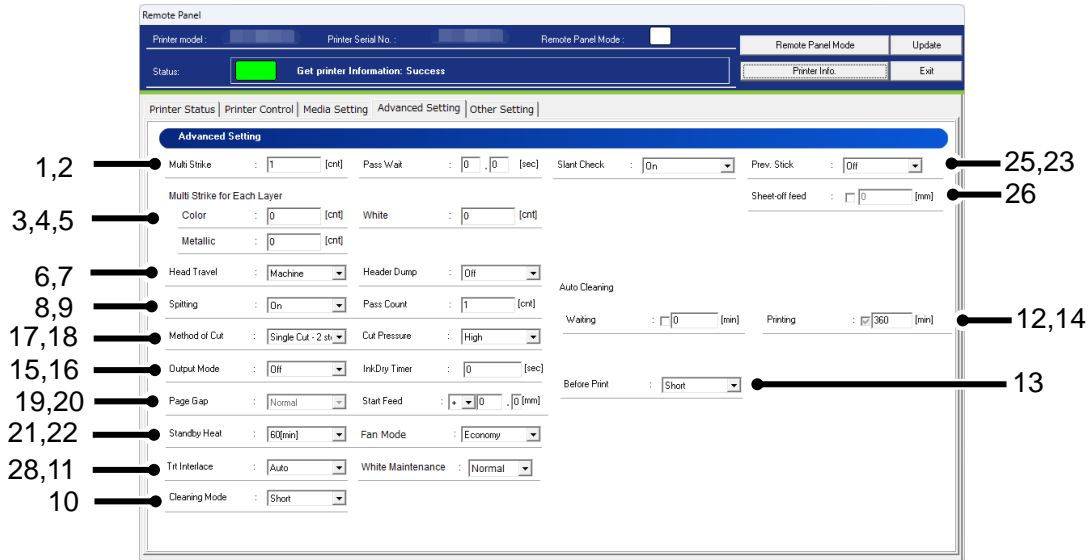

No.	Name	Description
1	Multi Strike	Set the overwrite count per line. Setting : < 1 Cnt > ~ 9 Cnt
2	Pass Wait	Set the waiting time while overwrite printing. Setting : < 0.0 sec > ~ 0.1 sec ~ 5.0 sec Use this setting when you want to print on the narrow media or the heater is unable to sufficiently warm up the media.
3	Multi Strike for Each Layer (Color) *6	Set the overwrite count for layer printing (Color) per line. Setting : < 1 Cnt > ~ 9 Cnt
4	Multi Strike for Each Layer (White) *6	Set the overwrite count for layer printing (White) per line. Setting : < 1 Cnt > ~ 9 Cnt
5	Multi Strike for Each Layer (Metalic) *7	Set the overwrite count for layer printing (Metalic) per line. Setting : < 1 Cnt > ~ 9 Cnt
6	Head Travel	Set the range that the print head moves while printing. Setting : Data / Machine / < Media Width >
7	Header Dump	Set whether to print the following information (dump data) of print data. The dump data will be used as a reference material to receive technical supports.
8	Spitting	Set the spitting operation while printing. Setting : < On > / Off

No.	Name	Description
9	Pass Count	Set the frequency (Pass Count) that the print head returns to the spitting box (located) on the origin side when setting "On" or "On Media" in the Spitting menu. Setting : < 1 Cnt > ~ 999 Cnt
10	Cleaning Mode	Select the cleaning mode for auto cleaning and sleep mode. Setting : short / < Normal > / < Long >
11	White Maintenance *8	Check and change the White Maintenance in the printer. Setting : < Normal > / Little
12	Auto Cleaning - Wait Time	Set the time for auto-cleaning in WaitingTime mode. VJ-628/628X: Setting : Off ~ 10 min ~ < 360 min > ~ 1440 min VJ-628MP: Setting : <Off> ~ 10 min ~ 360 min ~ 1440 min
13	Auto Cleaning - Before Print	Set the value for auto-cleaning in pre-printing mode. Setting : < Off > / On
14	Auto Cleaning - Printing Time	Select the time for auto-cleaning while printing. VJ-628/628X: Setting : < Off > ~ 5 min ~ 180 min VJ-628MP: Setting : 5 min ~ < 360min > ~ 1440 min
15	Output Mode	Set the media operation after printing. Setting : < Off > / Take-up *1 / Auto Cut
16	InkDry Timer	Set the ink drying time. Setting : < 0 sec > ~ 3600 sec (60 min)
17	Method of Cut *2	Set the media cutting operation after printing. Setting : SingleCut-2 steps / < SingleCut-3 steps > / DoubleCut-2 steps / DoubleCut-3 steps
18	Cut Pressure	Set the media cutting pressure for the cutting operation. Setting : Low / < High >
19	Page Gap *5	Set the margin between images. Setting : < Normal > / Narrow
20	Start Feed	Set the media feed amount at print start. Setting : -10.0mm ~ < 0 mm > ~ 500.0mm Unit : 0.1mm
21	Standby Heat	Set the time to preheat the heater while the printer is n standby mode. VJ-628/628X: Setting : Off ~ 10 min ~ < 60 min > VJ-628MP: Setting : Off ~ 10 min ~ < 60 min > ~ 2 hour ~ 8 hour
22	Fan Mode	Set whether to operate the suction fan during standby heating. Setting : < Standard (On) > / Economy (Off)
23	Prev. Stick *3	Set to prevent media from sticking when printing starts. Setting : < Off > / On

No.	Name	Description
24	Slant Check	Set the slanting detection during media loading. Setting : Off / < On >
25	Sheet-off feed	Specify the amount of roll media feeding before cut. Setting : < Off > ~ 1 mm ~ 250 mm
26	Frnt Interlace *10	Check and change the Front Interlace the printer. Setting : Off / < Auto >

NOTE

- If the previous version of F/W is installed, the settings may not be properly reflected. Make sure to install the latest F/W.
- *1 When the take-up unit is not installed, do not set Output mode to "Take-up".
By doing so, the product will be unable to function properly.
- *2 When the the media detection is set to "Off", the media cannot be cut automatically.
Some media may not be cut (cannot be cut at all or cannot be cut finely).
In such a case, set the "Output Mode menu" to "Off" and cut the media manually.
- *3 When the Output Mode menu is set to "Take-up", the setting for the Prev. Stick menu is disabled.
- *4 After replacing the roll media, set the roll media length again.
If the roll media length is not set, the residual quantity of roll media may not be displayed correctly.
- *5 When the Output Mode menu is set to "Take Up", the Page Gap menu will be available.
- *6 When the ink set of VJ-628X/628MP contains white ink and the Multi Strike is set to 1 count, the Multi Strike settings for color layer and white layer will be available.
- *7 When the ink set of VJ-628X contains metallic ink and the Multi Strike is set to 1 count, the Multi Strike setting for metallic layer will be available.
- *8 The White Maintenance menu is available only when the ink set of VJ-628X contains white ink.
- *9 The Print Stop menu is available when the Roll Length menu is set to either of Roll1, Roll2 or Roll3.
- *10 This function is available for VJ-628MP

13.1.6 Other Settings

User can check the initial printer settings and returns the settings of the printer to default.

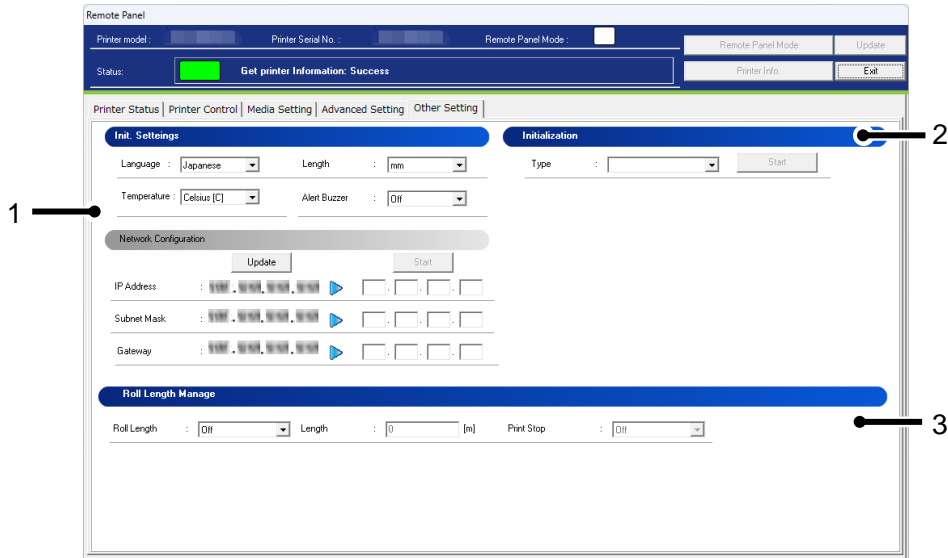

No.	Name	Description
1	Init. Setteings	Initial printer settings including network configuration are displayed.
2	Initialization	Initialize the each setting to factory default.
3	Roll Length Manage	Check and change the Roll Length Manage set in the printer.

13.1.6.1. Init. Settings

User can check the initial printer settings.

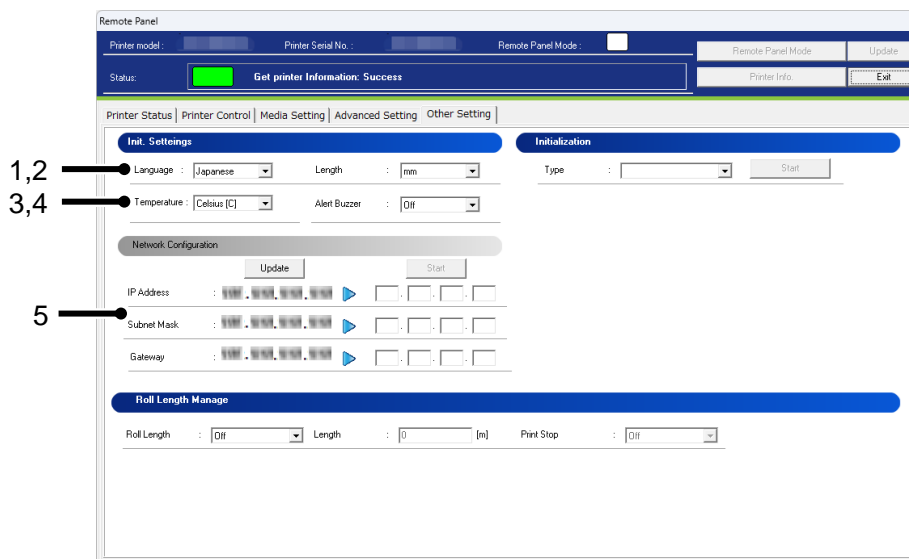

No.	Name	Description
1	Language	Check and change the Language in the printer. Setting : < English > / Japanese
2	Length	Check and change the Length in the printer. Setting : < mm > / inch
3	Temperature	Check and change the Temperature in the printer. Setting : < Celsius [C] > / Fahrenheit [F]
4	Alert Buzzer	Check and change the alert buzzer setting. Setting : < On > / Off
5	Network Configuration	Check and change the printer network configuration setting.

NOTE

- To change the network configuration, use the ValueJet Finder application contained in the bundled CDROM.

(1) Network Configuration

Check and change the current network configuration setting of the printer.

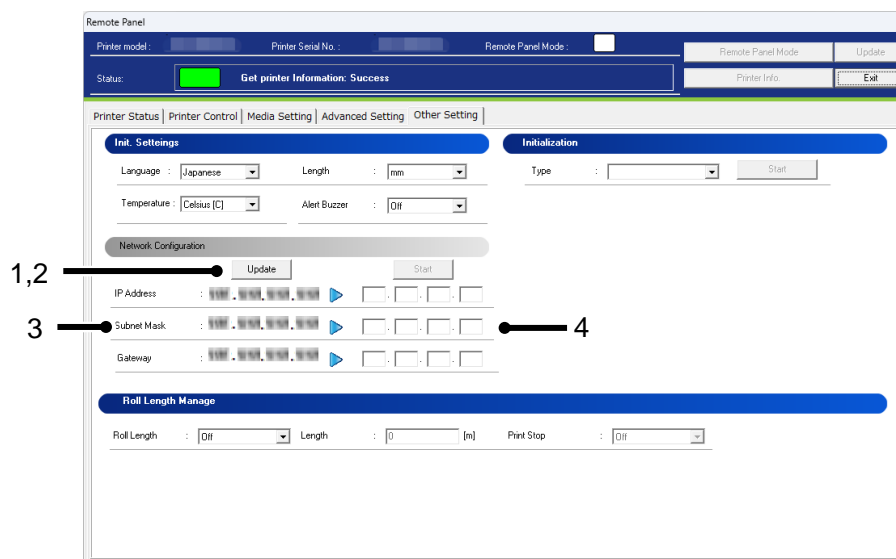

No.	Name	Description
1	Update	Enable input boxes (4) to enter new setting.
2	Start	Change the network configuration setting.
3	Current network configuration setting	Displays the current network configuration setting.
4	New network configuration setting	Enter the new network configuration setting that you want to change.

NOTE

- If the older F/W is used, the setting updates may not be reflected. Install the latest F/W.
- If you want to change the network configuration setting of the printer which does not support this function, change the setting using the ValueJet Finder application which comes with the printer.
- If you change the network configuration while printing, you cannot complete printing.
- If unable to communicate with the printer after changing the network configuration, restart your printer. If the communication is still not successful, check the network configuration from VJ Finder.

13.1.6.2. Initialization

Returns the settings of the printer to default.

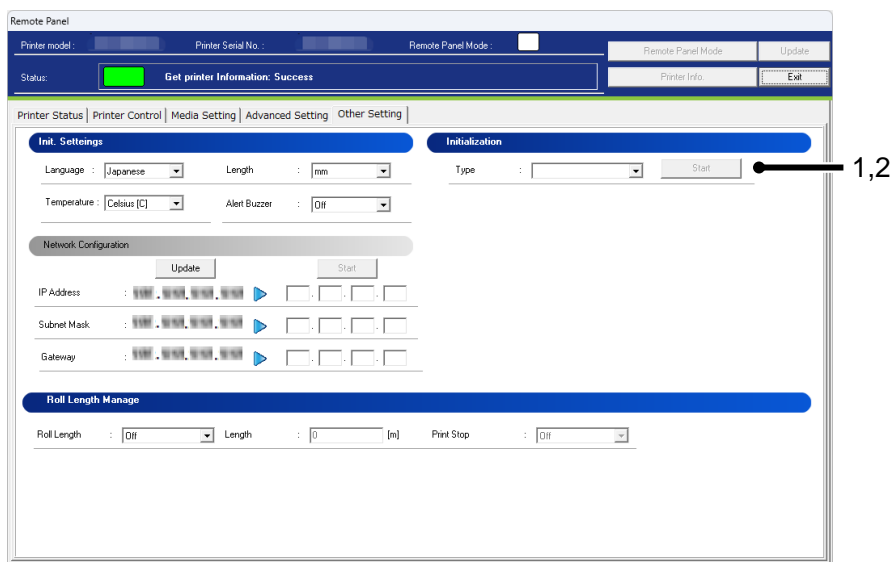

No.	Name	Description
1	Type	<p>ALL :</p> <p>All settings can be returned to factory default.</p> <p>Media Type :</p> <p>The setting of the Media Type is returned to factory default.</p> <p>Advanced Setting :</p> <p>Advanced setting is returned to factory default.</p> <p>Init. Setting :</p> <p>Initial setting is returned to factory default.</p>
2	Start	Initialize the selected setting to the factory default.

NOTE

- The network configuration cannot be initialized.
To change the network configuration, use the ValueJet Finder application contained in the bundled CDROM.

13.1.6.3. Roll Length Manage

Check and change the Roll Length Manage set in the printer.

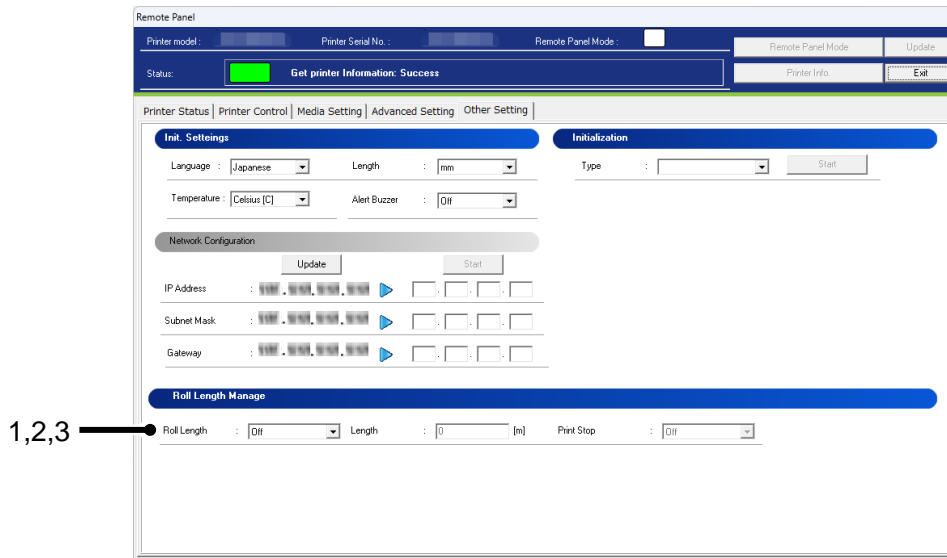

No.	Name	Description
1	Roll Length	Set the roll media length. Setting : < Off > / Roll1 / Roll2 / Roll3
2	Length *1	Set the roll media length. Setting : 1 m ~ < 30 m > ~ 200 m
3	Print Stop *2	Specify whether to stop printing when the remaining roll media is 0[m]. Setting : < Off > / On

NOTE

- *1 After replacing the roll media, set the roll media length again.
If the roll media length is not set, the residual quantity of roll media may not be displayed correctly.
- *2 The Print Stop menu is available when the Roll Length menu is set to either of Roll1, Roll2 or Roll3.

13.1.7 Plug Lifetime

Check and initialize the plug lifetime counter on the high-capacity ink pack adaptor.

13.1.7.1. Reset Plug Lifetime Counter



No.	Name	Description
1	Plug Lifetime	<p>Indicate the plug life status of each slot. *Only when the high-capacity ink pack adaptor is loaded, the status bar is enabled.</p> <p> : No adaptor loaded : Available(100~81%) : Available (80~61%) : Available (60~41%) : Available (40~21%) : Near end of life (20%~1%) : End of life (0%) </p>
2	Reset Counter	Initialize the plug lifetime counter of the selected slot.

NOTE

- If no high-capacity ink pack adaptor is loaded, this menu will not be displayed.
- For information on how to replace the plug, see the High-Capacity Ink Pack Adaptor Operation Manual.

13.1.7.2. Confirmation

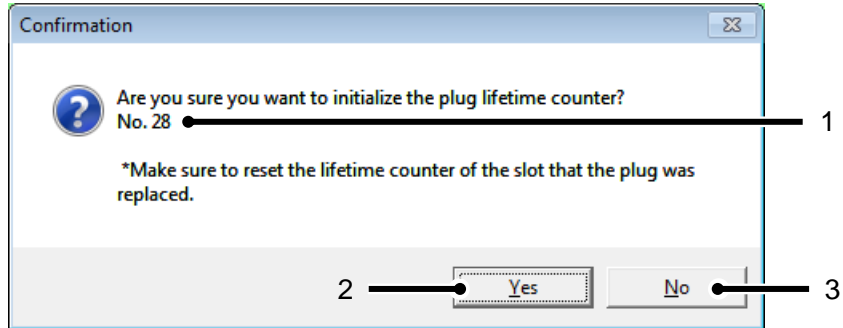



No.	Name	Description
1	Slot No.	The slot number of the plug lifetime counter to be initialized is displayed.
2	Yes	Initialize the counter.
3	No	Cancel the initialization.

13.2. VJ-1x38(W)X/1x24(W)X/1628X/2638X/1938TX/1638UH(2)/1948WX/1324XS/1638UR(2)/162xMH

13.2.1 Remote Panel

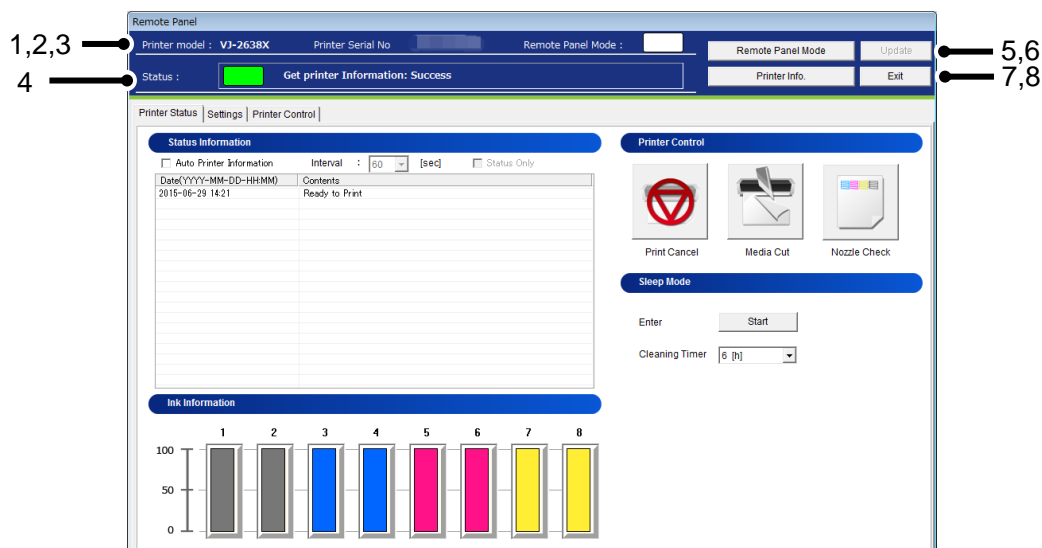
Check the printer information and the remote panel status.



No.	Name	Description
1	Printer model	The selected printer model is displayed.
2	Printer Serial No.	The serial number of selected printer is displayed.
3	Remote Panel Mode(Status)	Displays current remote panel mode from:  Remote Panel Mode On  Remote Panel Mode Off
4	Status	The remote panel status is displayed.
5	Remote Panel Mode Button	Enable/Disable remote panel mode.
6	Update	Change the printer settings.
7	Printer Information button	Get current panel setting information from your printer. *Printer information of the selected tab is obtained.
8	Exit button	Exit the Remote Panel menu.

13.2.2 Printer Status

Displays the printer status and remotely operate the printer.

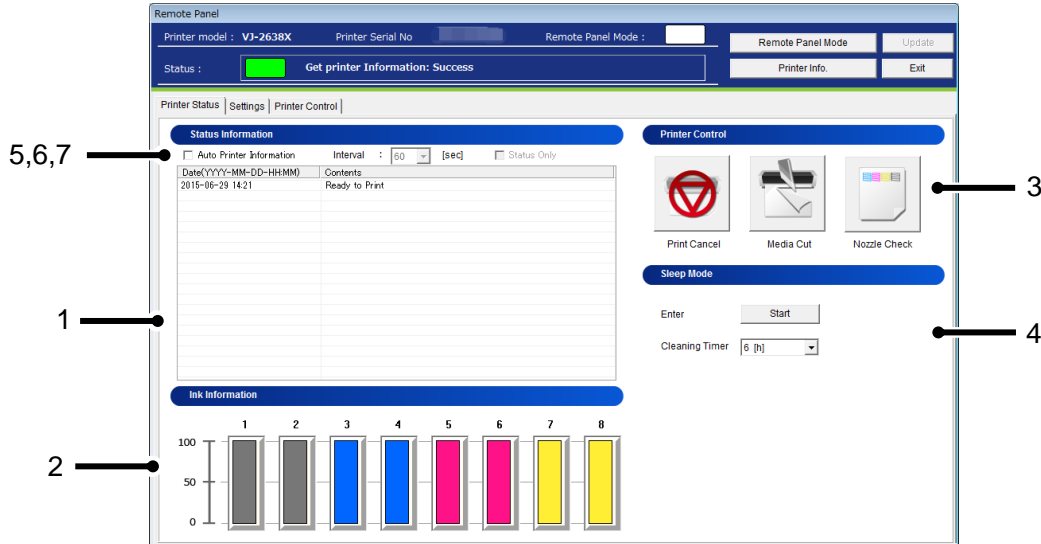

No.	Name	Description
1	Status Information	The current printer status is displayed. If the printer encounters a system error, a workaround will be displayed.
2	Ink Information	The remaining ink amount of the printer is displayed. For the details of S/C card recovery, see 7.7.2 S/C Card Recovery.
3	Printer Control *1	Remotely perform the following operations: •Print Cancel •Media Cut •Nozzle Check
4	Sleep Mode	Remotely switch the printer to Sleep Mode.
5	Auto Printer Information	Check this box to automatically get printer information. On : Enable Off : Disable *This function is not available when MSM is launched from the Windows printer driver.
6	Interval	When “Auto Printer Information” is ON, set a time interval to get the latest information from the printer. Value can be set from: <60[sec]> / 30[sec] / 10[sec] / 3[sec]
7	Status Only	Check this box to obtain the printer status information only to minimize the data acquisition time. *This check box is enabled when “Auto Printer Information” is set to ON.

NOTE

- *1 Available functions vary by printer model.

13.2.3 Settings

Check and change the printer setting.

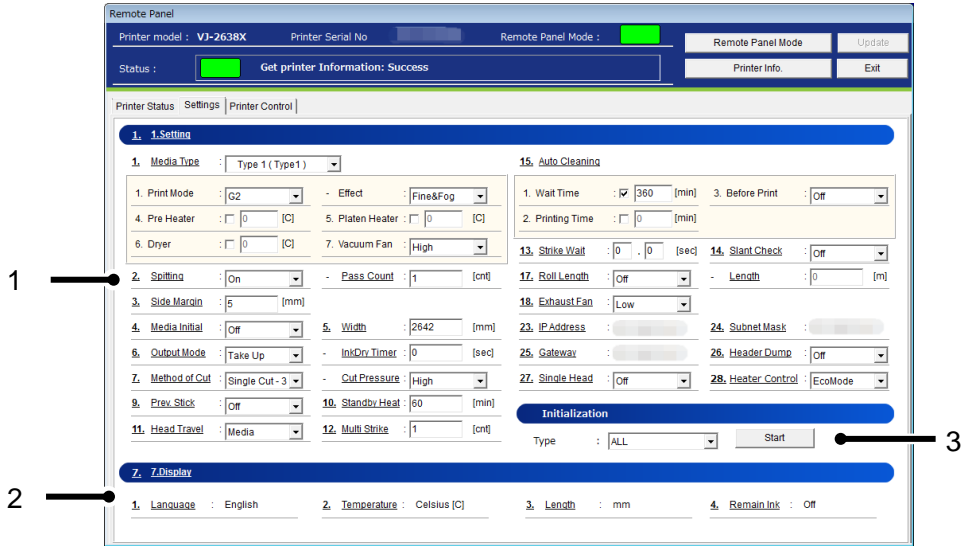

No.	Name	Description
1	Setting	Displays the panel setting in your printer. *Panel setting to be displayed varies depending on printer model.
2	Display	Displays the panel display setting in your printer. *Panel display setting to be displayed varies depending on printer model.
3	Initialization	Initialize the each setting to factory default.

NOTE

- Available functions vary by printer model.

13.2.4 Printer Control

Remotely operate the printer.

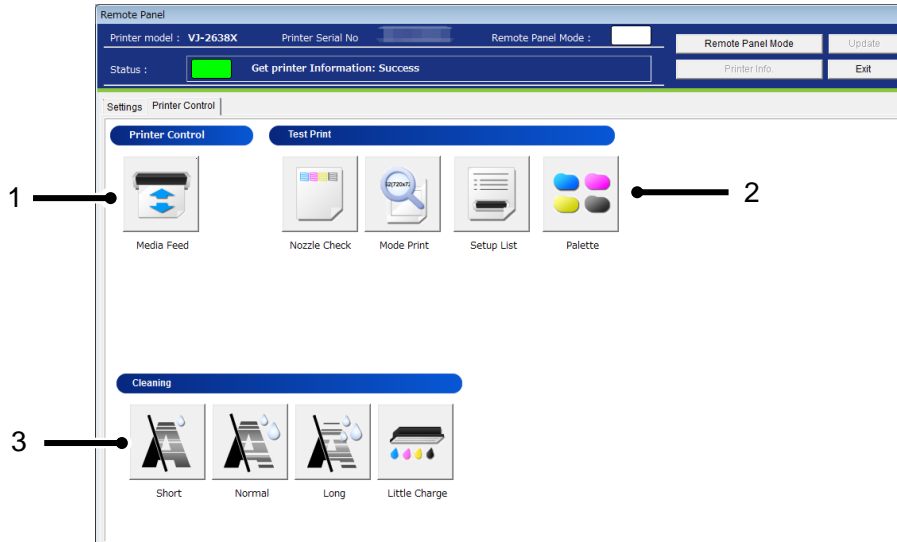

No.	Name	Description
1	Printer Control	Remotely operate the printer.
2	Test Print	Perform the test print selected from this menu.
3	Cleaning	Perform the cleaning selected from this menu.

13.2.4.1. Printer Control

Remotely operate the printer.

(1) Media Feed

Specify the feeding amount of media set in the printer and feed it in forward/ backward with the specified amount.

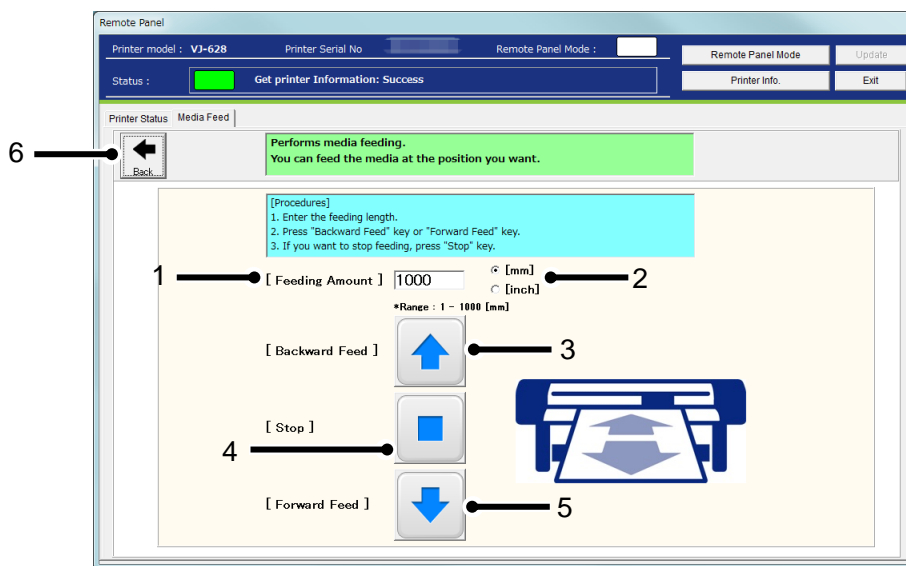

No.	Name	Description
1	Feeding Amount	Specify the media feeding amount range between: • In [mm] setting: 1 ~ < 1000 mm > (in increments of 1 mm) • In [inch] setting: 0.04 ~ < 39.37 inch > (in increments of 0.01 inch)
	Unit of Feeding Amount	Select the unit of feeding amount from: <mm> or inch
3	Backward Feed	Feed the media backward with the specified amount.
4	Stop	Stop the media feeding.
5	Forward Feed	Feed the media forward with the specified amount.
6	Back	Go back to the Printer Control Main Menu.

<> Default setting

NOTE

- The printer will feed the media according to the setting you specified. Make sure to specify the appropriate amount to prevent unwinding.

13.2.4.2. Test Print

Perform the test print selected from the menu.

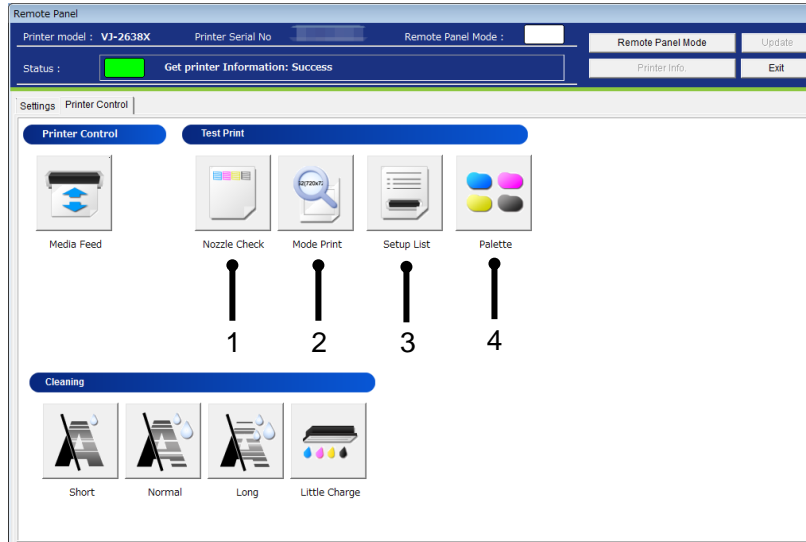

No.	Name	Description
1	Nozzle Check	Print the nozzle check pattern.
2	Mode Print	Print the printing conditions.
3	Setup List	Print the current printer setup list.
4	Palette	Print the palette pattern. *In some print modes, this menu is not available.

13.2.4.3. Cleaning

Performs head cleaning.

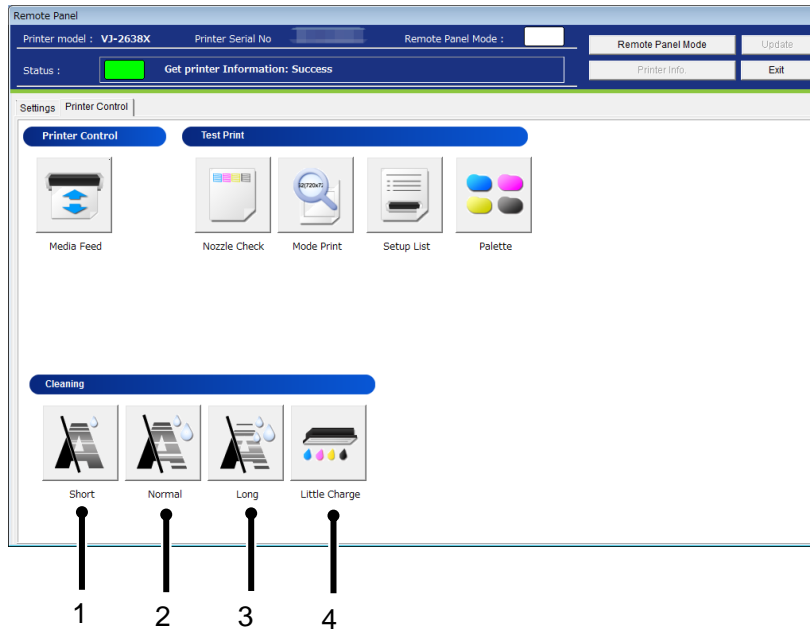

No.	Name	Description
1	Short Cleaning	Discharges smaller amount of ink compared to "Normal".
2	Normal Cleaning	Select this mode normally.
3	Long Cleaning	Discharges larger amount of ink compare to "Normal". Used when the print head does not improve by normal Head cleaning.
4	Little Charge	Refills a small amount of ink. Charge a small amount of ink when printing is not stable after initial ink charge.

NOTE

- Do not remove ink cartridges/ink bags during cleaning. Air may enter the ink tubes.

13.2.4.4. Maintenance

Remotely perform printer maintenances.

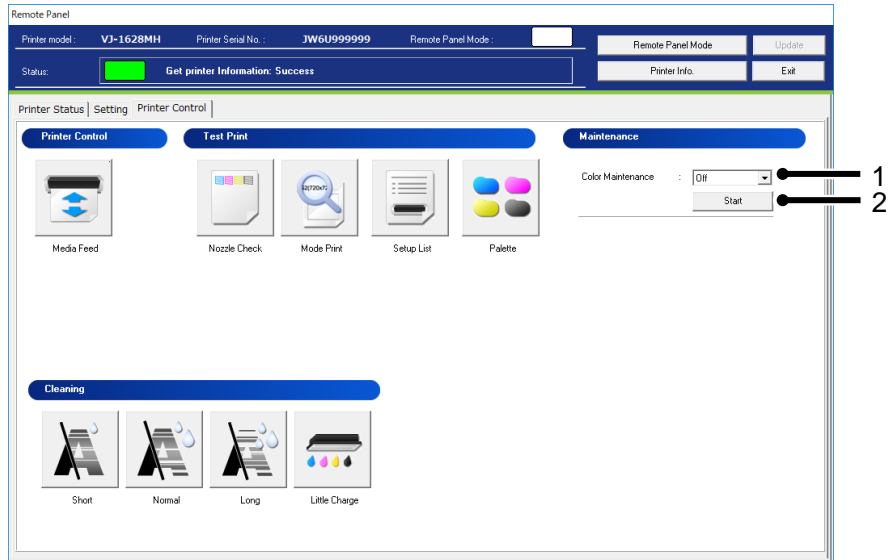

No.	Name	Description
1	Color Maintenance *1	Set the color maintenance. Setting : On / < Off >
2	Color Maintenance Start *1	Perform color maintenance.

NOTE



*1 This function is available for VJ-1628MH.

13.3. VJ-426UF / 626UF/XPJ-461UF/661UF/1462UF

13.3.1 Remote Panel

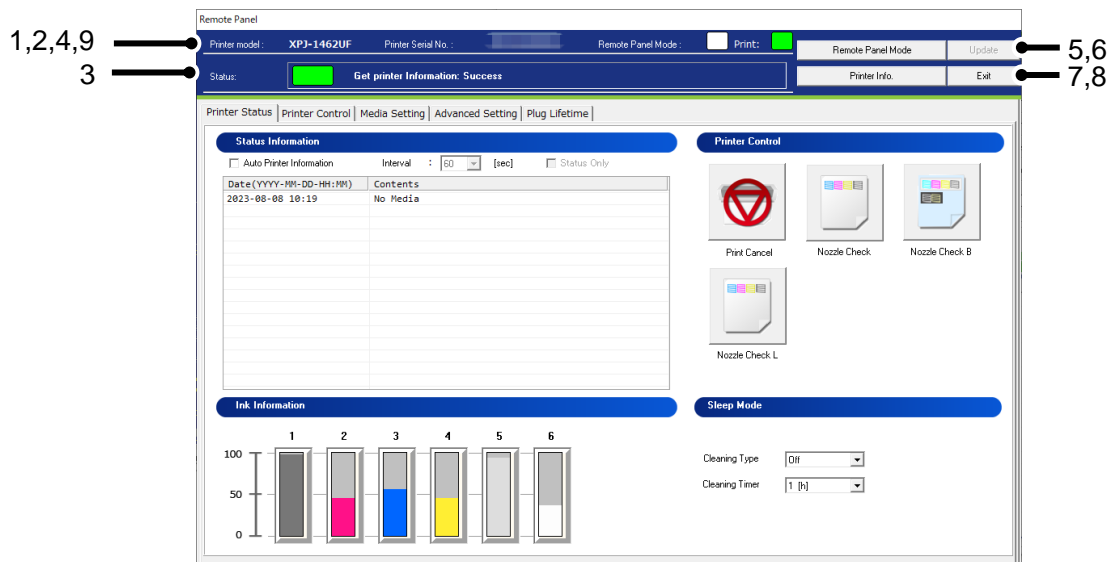
Check the printer information and the remote panel status.



No.	Name	Description
1	Printer model	The selected printer model is displayed.
2	Printer Serial No.	The serial number of selected printer is displayed.
3	Status	The remote panel status is displayed.
4	Remote Panel Mode(Status)	Displays current remote panel mode from:  Remote Panel Mode On  Remote Panel Mode Off
5	Remote Panel Mode Button	Get current panel setting information from your printer.
6	Update	Change the printer settings.
7	Printer Information button	Get current panel setting information from your printer. *Printer information of the selected tab is obtained.
8	Exit button	Exit the Remote Panel menu.

No.	Name	Description
9	Print *1	Displays Print mode from: <input checked="" type="checkbox"/> indicates that operator is not working on the table. <input type="checkbox"/> indicates that operator is working on the table.

NOTE

- *1 This function is available for XPJ-1462UF.
-

13.3.2 Printer Status

Displays the printer status and remotely operate the printer.

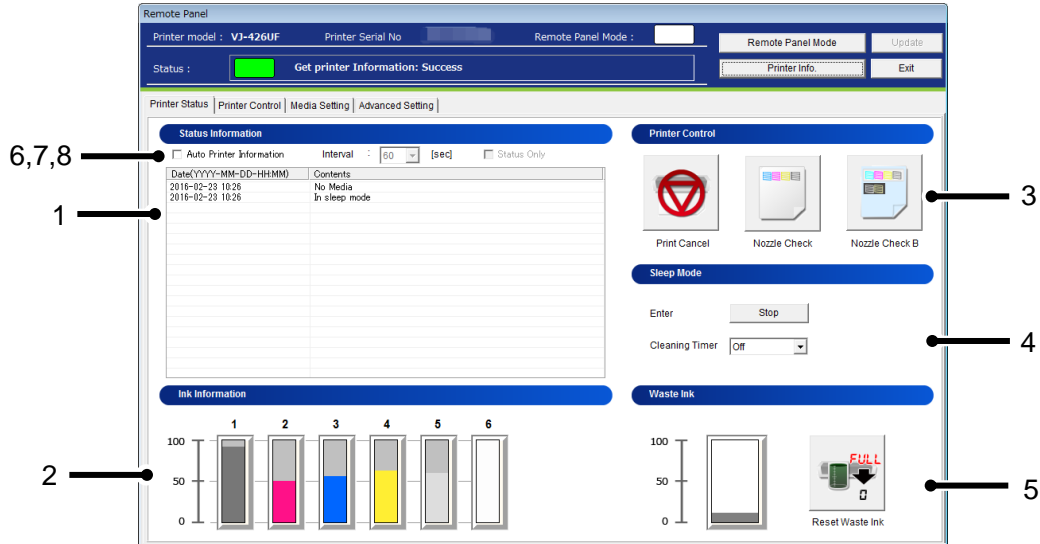

No.	Name	Description
1	Status Information	The current printer status is displayed. If the printer encounters a system error, a workaround will be displayed.
2	Ink Information	The remaining ink amount of the printer is displayed. For the details of S/C card recovery, see 7.7.2 S/C Card Recovery.
3	Printer Control	Remotely perform the following operations: Flat mode : •Print Cancel •Nozzle Check •Nozzle Check Rotary : •Print Cancel
4	Sleep Mode	Remotely switch the printer to Sleep Mode.
5	Waste Ink	The amount in the waste ink tank is displayed. The waste ink counter can be reset.
6	Auto Printer Information	Check this box to automatically get printer information. On : Enable Off : Disable *This function is not available when MSM is launched from the Windows printer driver.
7	Interval	When “Auto Printer Information” is ON, set a time interval to get the latest information from the printer. Value can be set from: <60[sec]> / 30[sec] / 10[sec] / 3[sec]
8	Status Only	Check this box to obtain the printer status information only to minimize the data acquisition time. *This check box is enabled when “Auto Printer Information” is set to ON.

13.3.3 Printer Control

Remotely operate the printer.

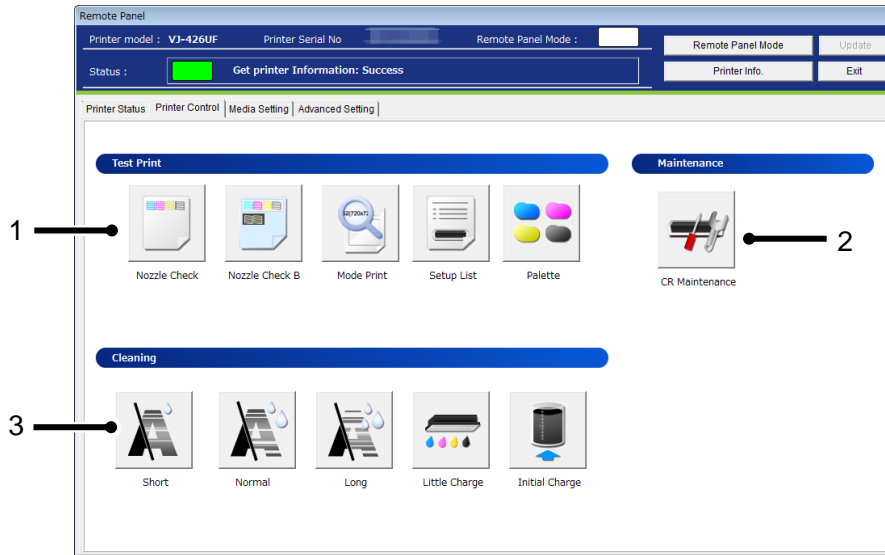

No.	Name	Description
1	Test Print *1	Perform the test print selected from this menu.
2	Maintenance *1	Perform the maintenance selected from this menu.
3	Cleaning	Perform the cleaning selected from this menu.

NOTE

- *1 This function is available for flat mode.

13.3.3.1. Test Print

Perform the test print selected from the menu.

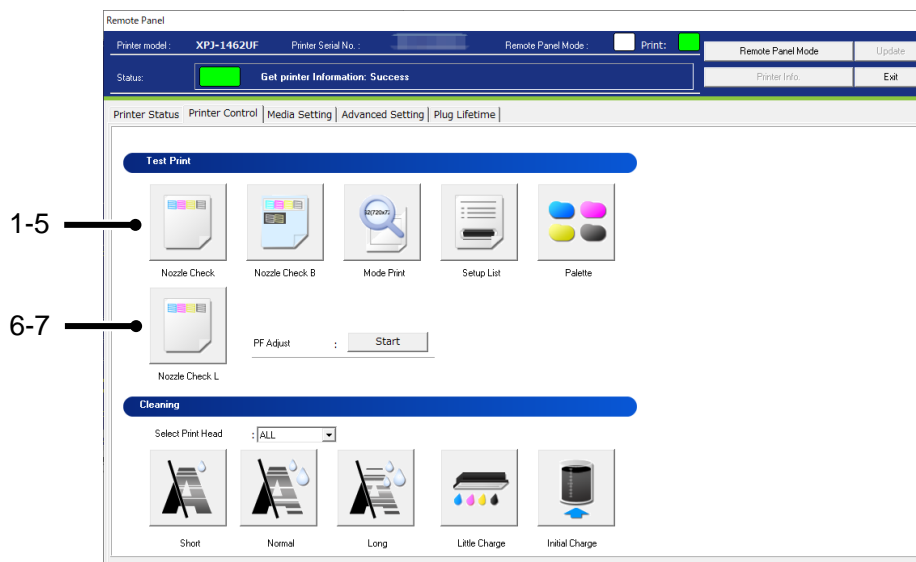

No.	Name	Description
1	Nozzle Check	Print the nozzle check pattern.
2	Nozzle Check B	Print the nozzle check B pattern.
3	Mode Print	Print the printing conditions.
4	Setup List	Print the current printer setup list.
5	Palette	Print the palette pattern. *In some print modes, this menu is not available.
6	Nozzle Check L *1	Print the nozzle check L pattern.
7	PF Adjust*1	Perform the paper feed adjustment of the media.

NOTE

- *1 This function is available for XPJ-1462UF.

13.3.3.2. Maintenance

Remotely perform printer maintenances.

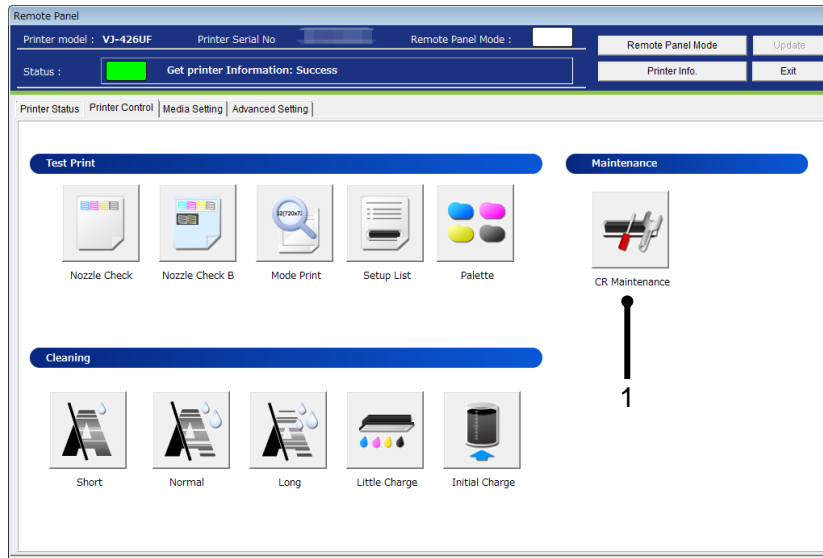

No.	Name	Description
1	CR Maintenance *1	Remotely perform CR Maintenances.

NOTE

- *1 This function is available for VJ-426UF.

(1) CR Maintenance

1) Check Printer Status

Before performing CR maintenance, check the printer status.

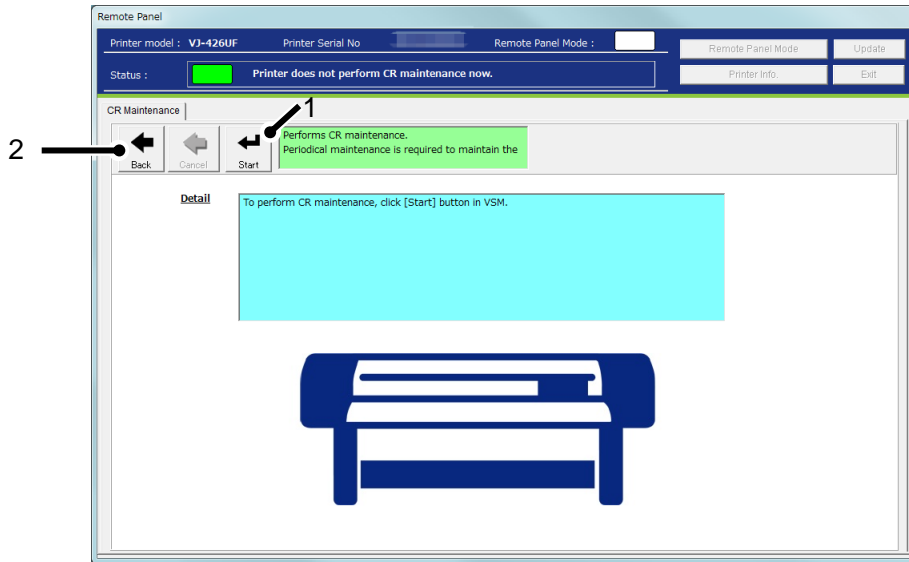

No.	Name	Description
1	Start	Instruct the printer to perform CR Maintenance.
2	Back	Go back to the Printer Control Main Menu.

2) Waiting to press [Operation] button in printer.

Before performing CR maintenance, press Operation key on the printer panel and then start CR maintenance.

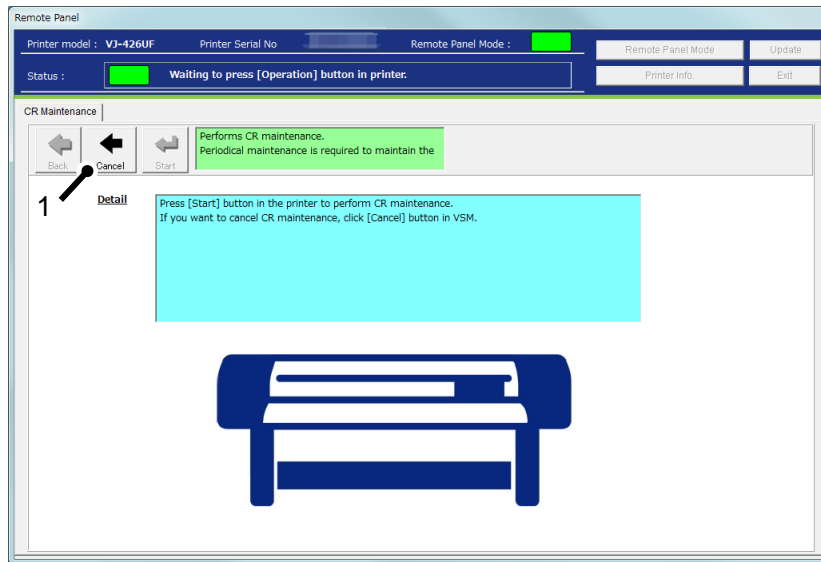

No.	Name	Description
1	Cancel	Cancel to perform CR maintenance.

NOTE

- Before starting CR maintenance, make sure to press Operation key on the printer panel.

3) Performing CR maintenance

CR maintenance is being performed in the printer.

After CR maintenance is completed, press Operation key on the printer panel.

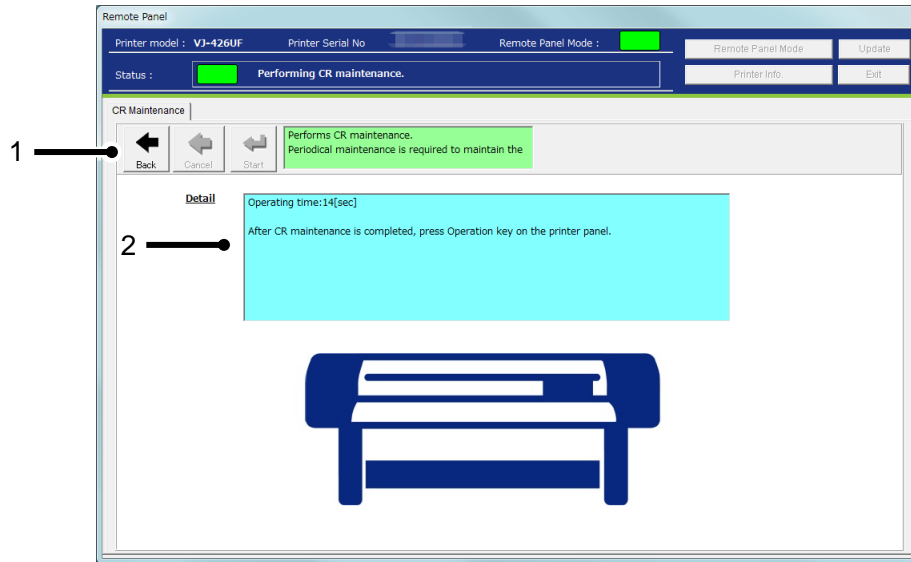

No.	Name	Description
1	Back	Go back to the Printer Control Main Menu.
2	Detail	CR maintenance elapsed time is displayed.

NOTE

- After CR maintenance is completed, make sure to press Operation key on the printer panel.

13.3.3.3. Cleaning

Performs head cleaning.

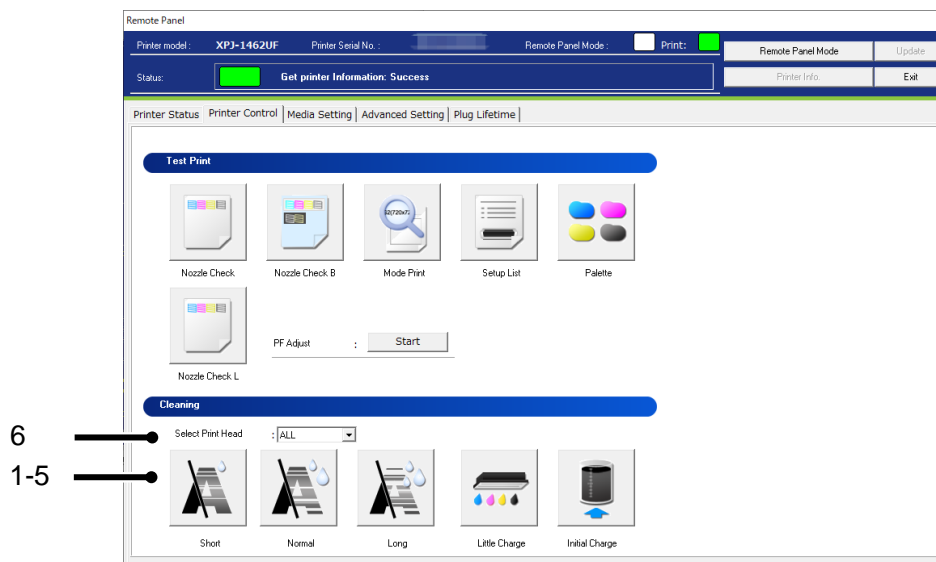

No.	Name	Description
1	Short Cleaning *1	Discharges smaller amount of ink compared to "Normal".
2	Normal Cleaning *1	Select this mode normally.
3	Long Cleaning *1	Discharges larger amount of ink compare to "Normal". Used when the print head does not improve by normal Head cleaning.
4	Little Charge *1	Refills a small amount of ink. Charge a small amount of ink when printing is not stable after initial ink charge.
5	Initial Charge	Perform initial ink charge. Refer to the (1)Initial Charge for the details.
6	Select Print Head *1	Select the print head to be cleaned if the printer has more than one print head. Setting : <ALL> / Head 1 / Head 2

NOTE

- Do not remove ink cartridges/ink bags during cleaning. Air may enter the ink tubes.
- *1 Head selection is possible with XPJ-1462UF.

(1)Initial Charge

Perform the initial ink charge after ink cartridges are inserted into the correct slots.

1)Empty Waste Ink Tank

Empty the waste ink tank before performing initial ink charge.

After disposing the waste ink, click [Start] button to reset the waste ink counter.

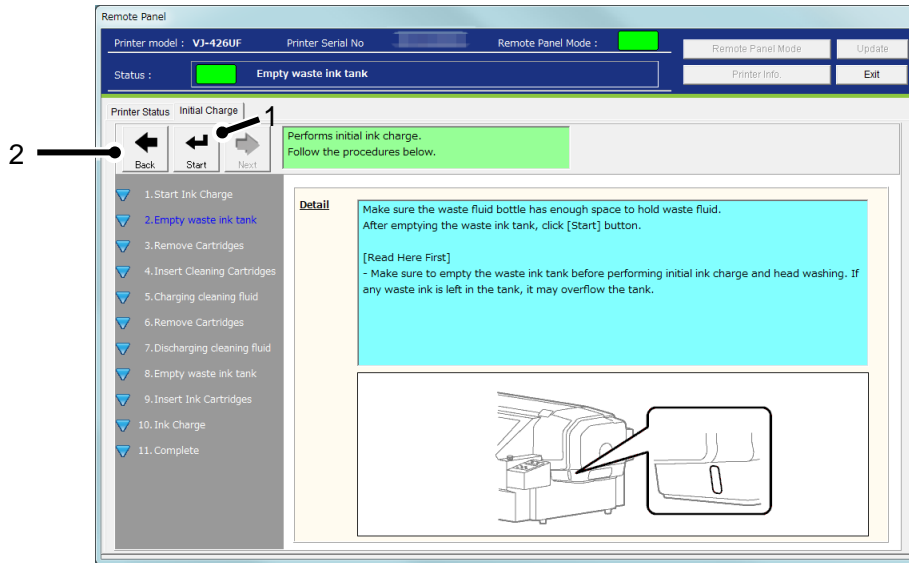

No.	Name	Description
1	Start	Reset the waste ink counter.
2	Back	Go back to the Printer Control Main Menu.

NOTE

- Initial charge produces waste ink. Make sure to empty the waste ink tank before performing the initial ink charge. If waste ink is left in the tank, it may overflow the tank.

2) Insert Ink Cartridges

After the counter reset, insert the ink cartridges.

After the ink cartridges are inserted into the correct slots, the printer will start initial ink charge.

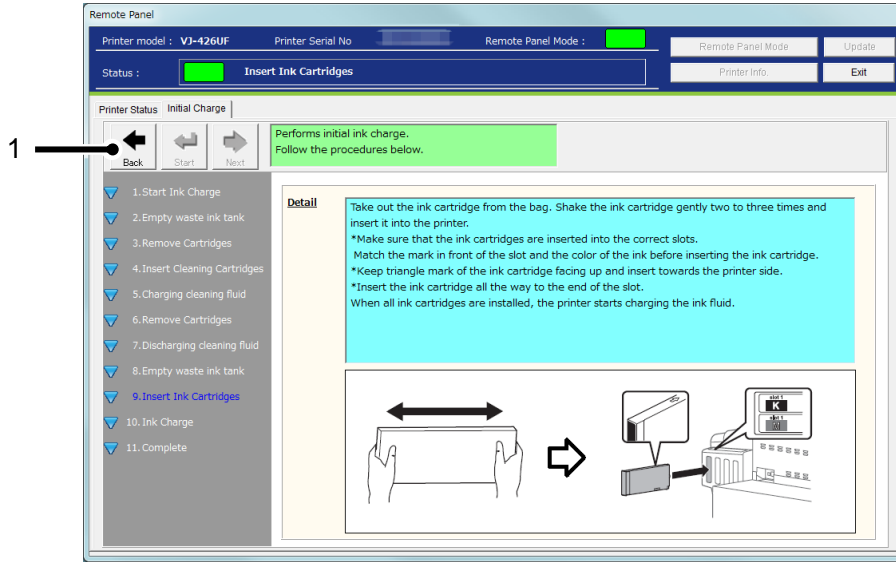

No.	Name	Description
1	Back	Go back to the Printer Control Main Menu.

3) Ink Charge

The printer is charging inks.

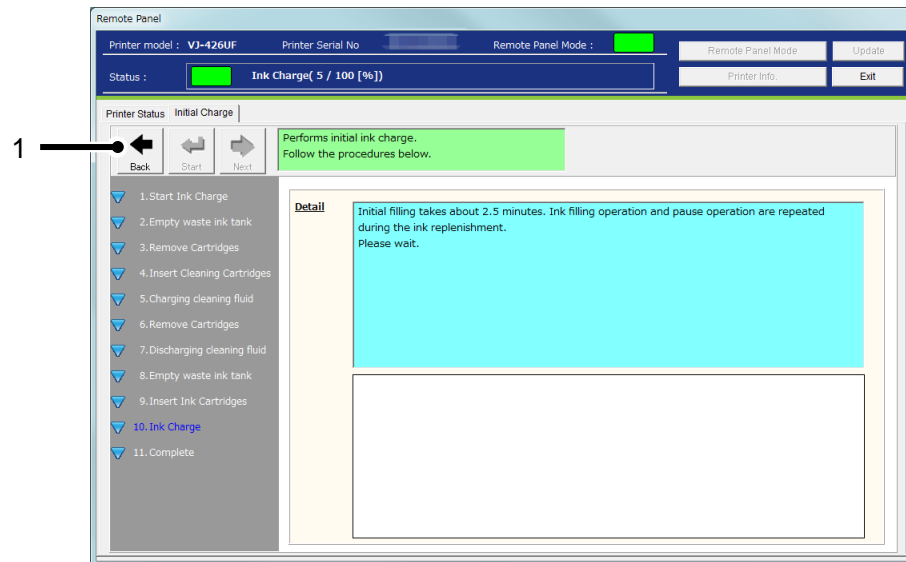

No.	Name	Description
1	Back	Go back to the Printer Control Main Menu.

4) Complete

Initial ink charge has been completed.

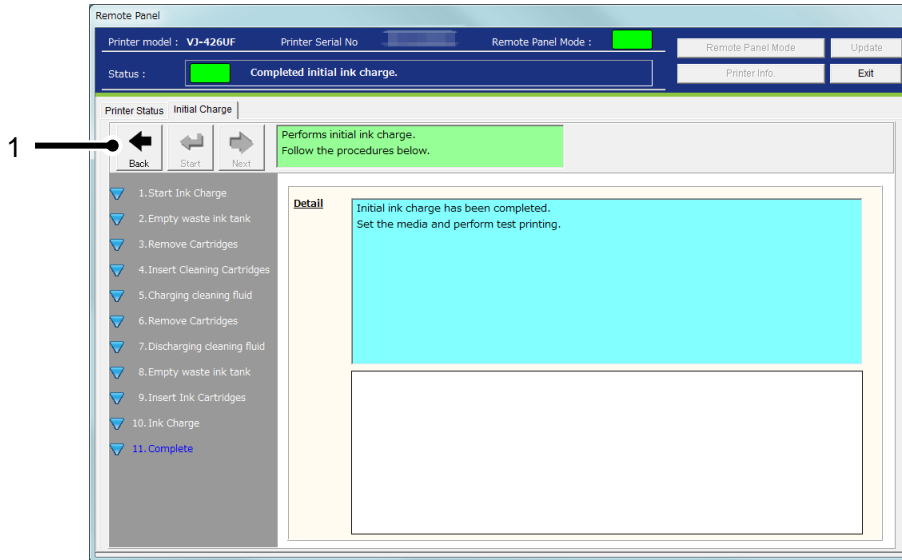

No.	Name	Description
1	Back	Go back to the Printer Control Main Menu.

13.3.4 Media Setting

Check and change the media setting.

If you use more than one media, you can store the each media setting including the heater temperature from this menu.

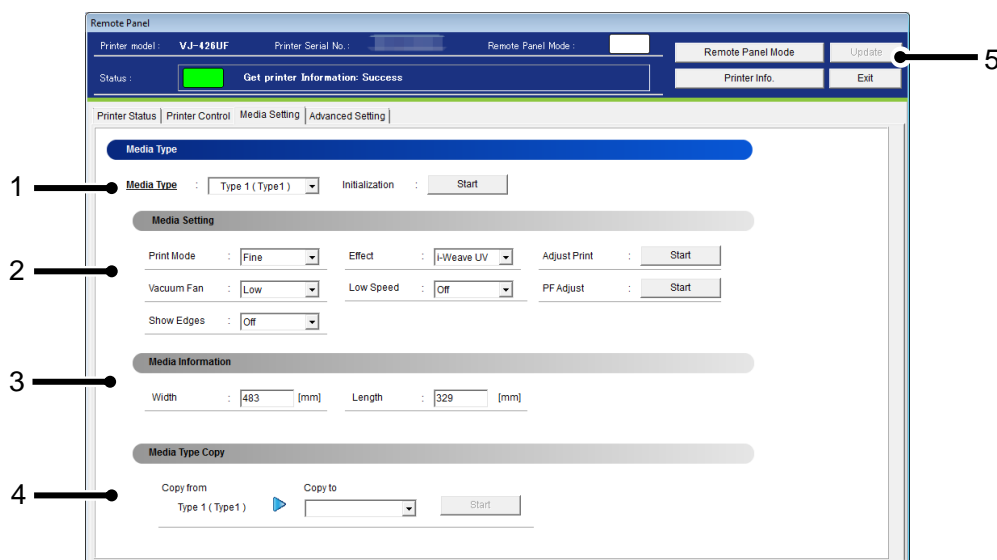

No.	Name	Description
1	Media Type	Check and change the media type loaded in the printer.
2	Media Setting	Check and change the current media setting.
3	Media Information	Check and change the media information set in the printer.
4	Media Type Copy	Copy the current media setting to other Media Type.
5	Update	Change the media setting.

NOTE

- To change the setting, change the values or settings and then click [Update] button.
- Multiple settings can be changed at once.

13.3.4.1. Media Type

Check and change the Media Type loaded in the printer.

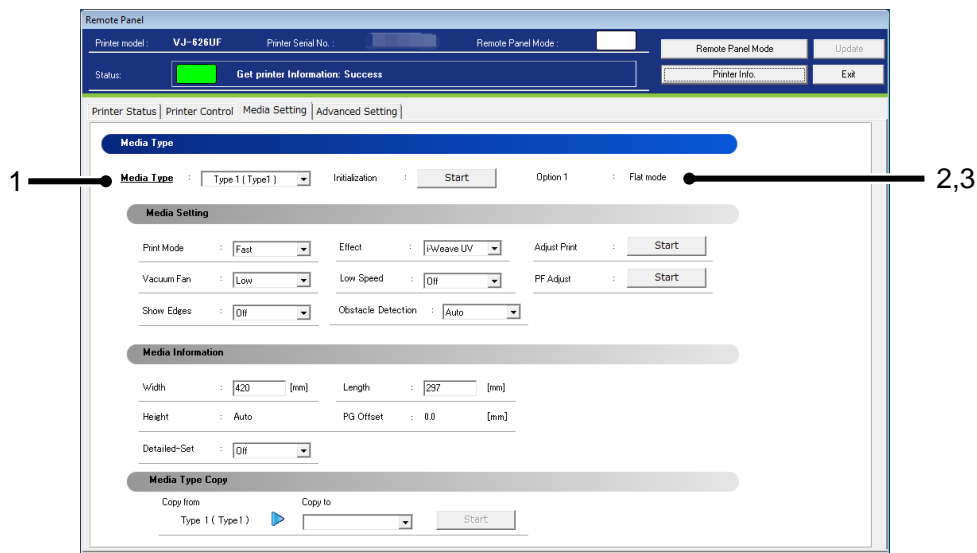

No.	Name	Description
1	Media Type	Check and change the Media Type loaded in the printer.
2	Initialization	Reset the Media Type currently loaded in the printer.
3	Option 1 *1	Displays the 'Option 1' setting on the printer operation panel. Flat mode : Normal printing mode. Rotary mode: Cylindrical printing mode using Rotary Unit.

NOTE

- To change the setting, change the values or settings and then click [Update] button.
- *1 This function is available for VJ-626UF/XPJ-661UF.

13.3.4.2. Media Setting

Check and change the media setting currently loaded in the printer.

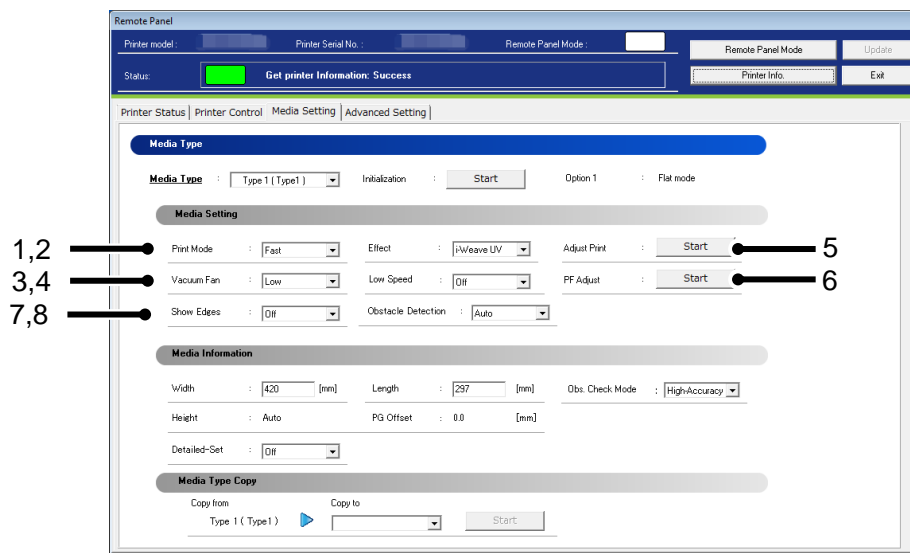

No.	Name	Description
1	Print Mode	Check and change the Print Mode of the media. Flat mode : Setting : Fast / <Fine> / Super Fine Rotary mode : Setting : < Balance > / Fine / Super Fine XPJ-1462UF: Setting : Build Up / <Quality> / Production / High Speed / Draft
2	Effect *1	Check and change the Effect of the media. Setting : None / <i-Weave UV> XPJ-1462UF : Setting : None / <i-Weave UV Ex>
3	Vacuum Fan *1,2,3	Check and change the vacuum fan of the media. Setting : Low / Medium / Medium-Hi / <High> / Off
4	Low Speed	Check and change the Low Speed setting of the media. Setting : <Off> / 50% / 25% XPJ-1462UF : Setting : <Off> / 50%
5	Adjust Print *1	Perform Bi-D adjustment for the media. * If other than “100%” is selected in “Speed Control”, this function is invalid.

No.	Name	Description
6	PF Adjust*1,3	Perform the paper feed adjustment of the media.
7	Show Edges *3	Specify whether to confirm the outer edges (and corners) of the output area by blinking LED. Setting :<Off> / Step / Auto
8	Obstacle Detection*1	Check and change the obstacle detection setting applied to the printer. VJ-426UF/XPJ-461UF : Setting :<Print Cancel> / Confirm VJ-626UF/XPJ-661UF: Setting :<Auto> / Print Cancel / Confirm XPJ-1462UF: Setting :<Off> / Auto / Print Cancel / Confirm

NOTE

- To change the setting, change the values or settings and then click [Update] button.
- Multiple settings can be changed at once.
- If the older F/W is used, the setting updates may not be reflected. Install the latest F/W.
- *1 This function is available for flat mode.
- *2 [XPJ-461UF] This function is enabled only when the optional vacuum table is installed in the printer.
- *3 XPJ-1462UF is not supported

(1) Adjust Print

Perform Bi-D adjustment for the media loaded in the printer.

1) Confirmation

Print the adjustment pattern in the current setting.

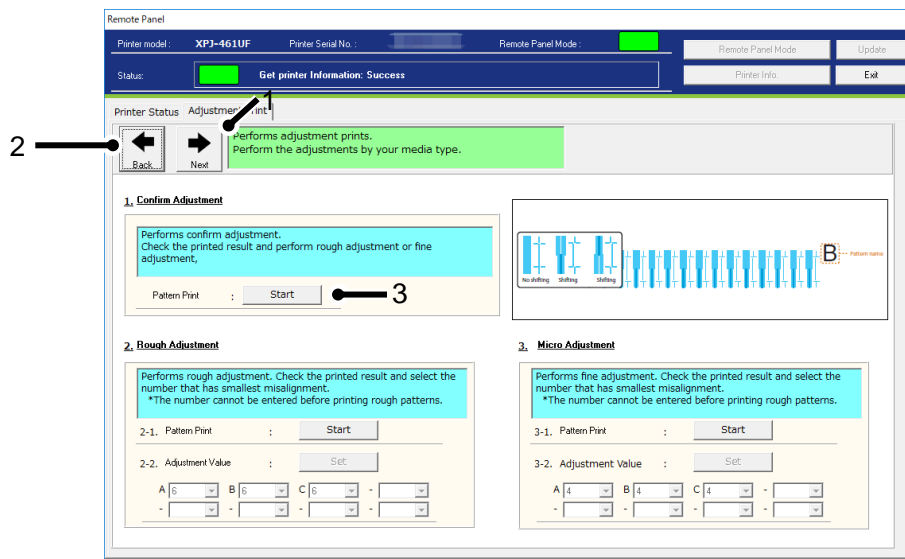

No.	Name	Description
1	Next	Go to the Media Setting Menu.
2	Back	Go back to the Media Setting Menu.
3	Start	Print the adjustment pattern in the current setting.

2) Rough Adjustment

Perform rough adjustment.

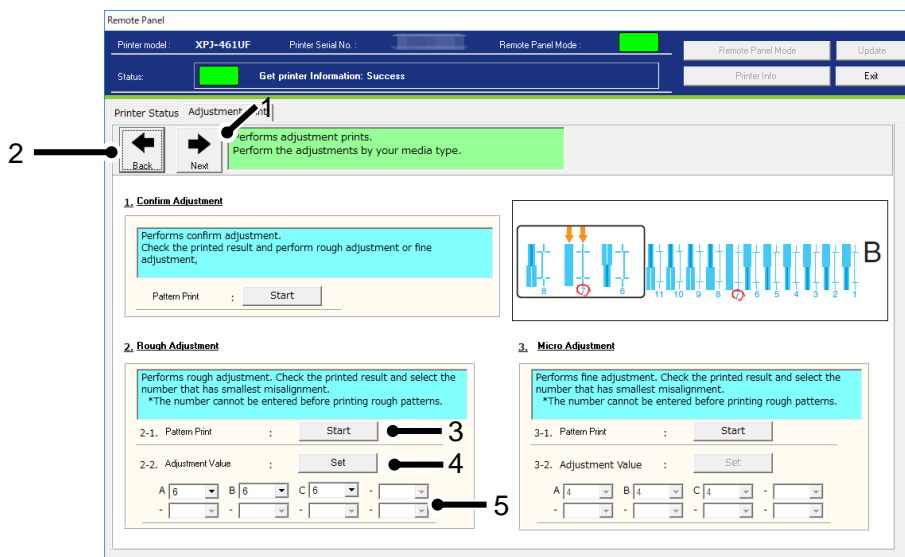

No.	Name	Description
1	Next	Go to the Media Setting Menu.
2	Back	Go back to the Media Setting Menu.
3	Start	Print the rough adjustment pattern.
4	Set	Set the adjustment value to the printer after the value change.
5	Adjustment Value	Change each adjustment value. *Adjustment patterns and adjustment range vary depending on the printer or ink type you use.

3) Micro Adjustment

Perform micro adjustment.

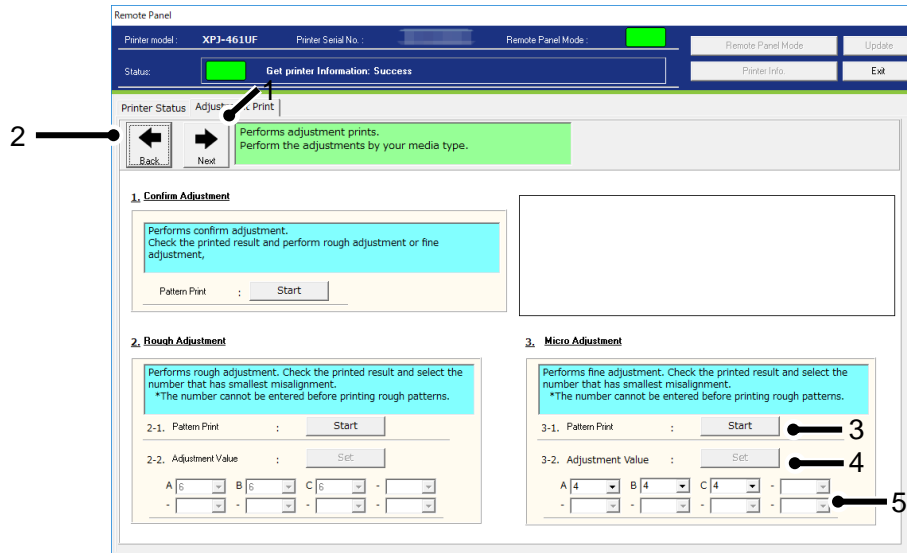

No.	Name	Description
1	Next	Go to the Media Setting Menu.
2	Back	Go back to the Media Setting Menu.
3	Start	Print the rough adjustment pattern.
4	Set	Set the adjustment value to the printer after the value change.
5	Adjustment Value	Change each adjustment value. *Adjustment patterns and adjustment range vary depending on the printer or ink type you use.

(2) PF Adjust

Perform the paper feed adjustment.

1) Initial Adjust

Performs initial adjustment.

Click [Start] button to print initial adjustment pattern and measure the distance between the printed two pluses (+)

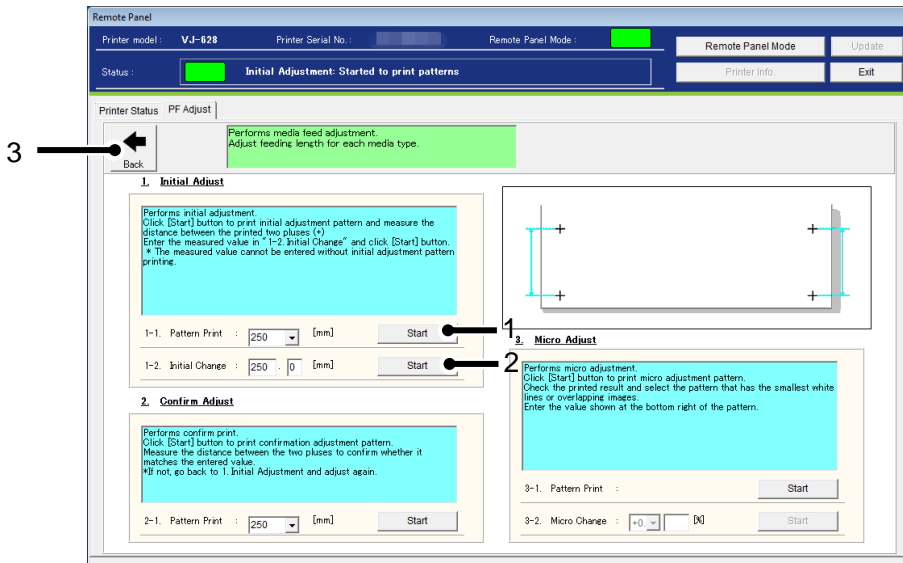

No.	Name	Description
1	Pattern Print - Start	Print the initial PF adjustment pattern. VJ-426UF : Pattern length : 100 [mm] ~ < 250 [mm] > ~ 300 [mm] VJ-626UF : Pattern length : 100 [mm] ~ < 250 [mm] > ~ 500 [mm] (in increments of 50 [mm])
2	Initial Change - Start	Set the initial PF adjustment value to the printer. Adjustable range : ±10.0 [mm] from the initial PF adjustment pattern (in increments of 0.1[mm]). e.g.) If the initial PF adjustment pattern is set to 250[mm], the adjustable range will be 240 [mm] ~ 260 [mm].
3	Back	Go back to the Media Setting Menu.

2) Confirm Adjust

Performs confirm print.

Click [Start] button to print confirmation adjustment pattern.

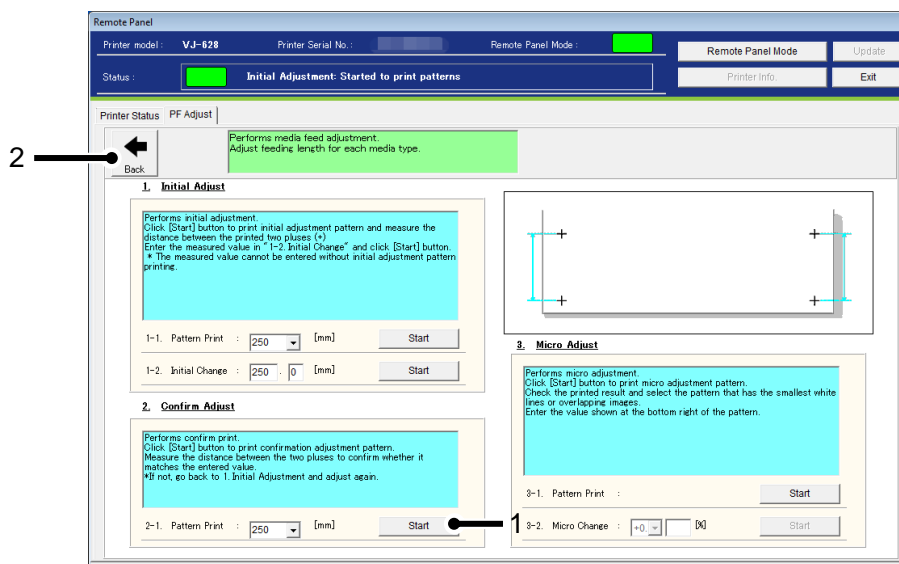

No.	Name	Description
1	Pattern Print - Start	Print the PF adjustment pattern with current setting. VJ-426UF : Pattern length : 100 [mm] ~ < 250 [mm] > ~ 300 [mm] VJ-626UF : Pattern length : 100 [mm] ~ < 250 [mm] > ~ 500 [mm] (in increments of 50 [mm])
2	Back	Go back to the Media Setting Menu.

3) Micro Adjust

Performs micro adjustment.

Click [Start] button to print micro adjustment pattern.

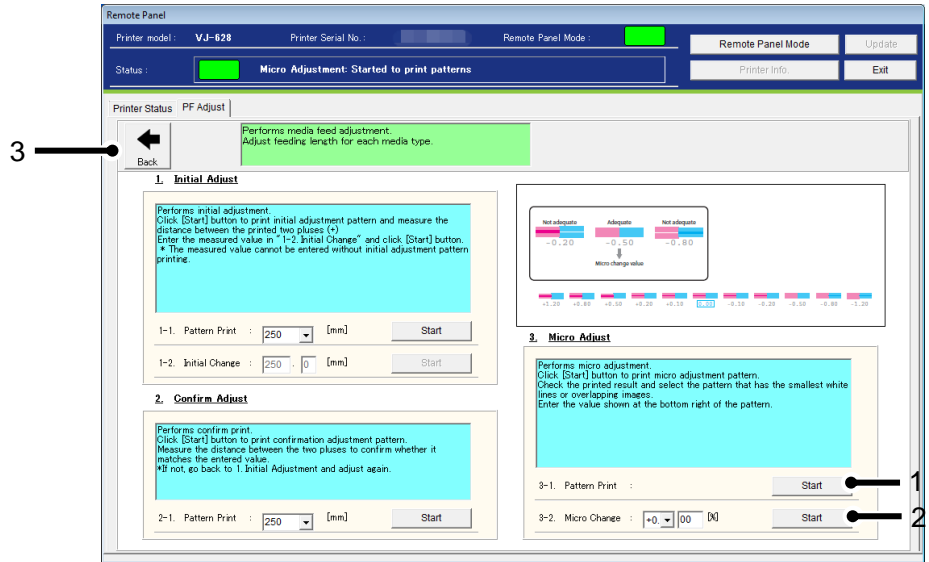

No.	Name	Description
1	Pattern Print - Start	Print the PF adjustment pattern with current setting.
2	Micro Change - Start	Set the micro adjustment value to the printer. Adjustable range: ± 5.00 [%] from the initial PF adjustment pattern (in increments of 0.01[%]).
3	Back	Go back to the Media Setting Menu.

13.3.4.3. Media Information

Check and change the width and thickness of the media set in the printer.

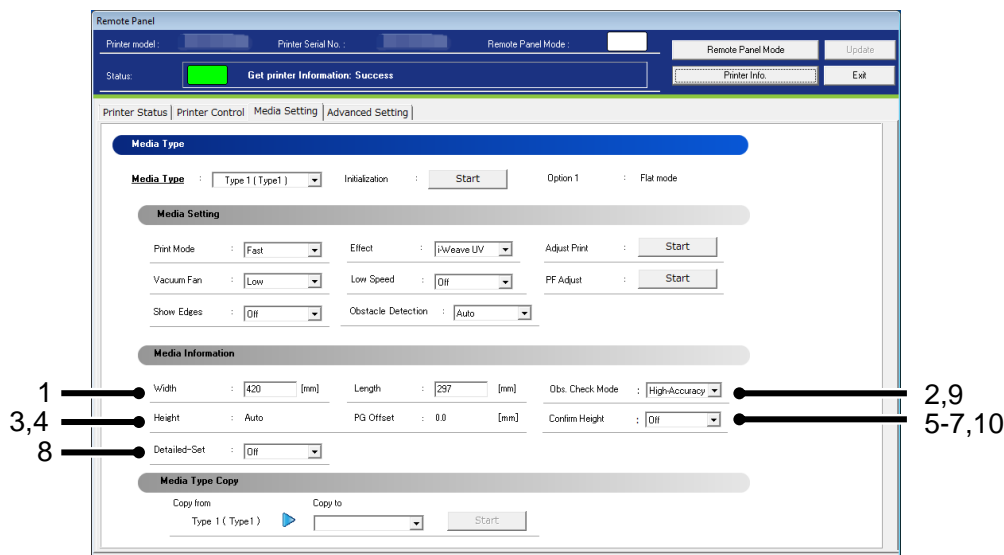

No.	Name	Description
1	Width	<p>Check and change the width of media.</p> <p>VJ-426UF/XPJ-461UF: Setting : 30 mm ~ < 483 mm ></p> <p>VJ-626UF/XPJ-661UF Flat mode : Setting : 30 mm ~ < 483 mm > Rotary mode : Setting : 30 mm ~ < 360 mm ></p> <p>XPJ-1462UF: Setting : 30 mm ~ < 1420 mm ></p>
2	Length	<p>Check and change the Length of media.</p> <p>VJ-426UF/XPJ-461UF: Setting : 30 mm ~ < 329 mm ></p> <p>VJ-626UF/XPJ-661UF: Flat mode : Setting : 30 mm ~ < 594 min > Rotary mode : Setting : 20 mm ~ < 405 mm ></p> <p>XPJ-1462UF: Setting : 30 mm ~ < 700 mm ></p>

No.	Name	Description
3	Height *1,2	Check the height setting of media. Setting : < Auto > / Manual
4	Roller Pitch *1,3	Check the roller pitch setting. Setting : < Wide > / Narrow
5	PG Offset *1,2 *When "Height" is set to Auto	Check the PG Offset of media. Setting : < 0.0 mm > ~ 1.5 mm
6	Media Height *1,2 *When "Height" is set to Manual	Check the height of media. Setting : < 0.0 mm > ~ 150.0 mm
7	Diameter *1,3	Check the diameter. Roller Pitch : Wide : Setting : 60.0 mm ~ 125.0 mm Narrow : Setting : 27.0 mm ~ 80.0 mm
8	Detailed-Set *1	Check and change the detailed setting of media. Setting : Off / < On >
9	Obstacle check mode *4	Check and change the obstacle check mode of media. Setting : <Normal> / High-Accuracy
10	Confirm Height *5	Check and change the confirm height of media. Setting : < Off > / On

NOTE

- The automatic adjustment determines the approximation. If you want to perform exactly accurate adjustment, the additional adjustment should be required.
- If you are unsure of the media thickness, but the adjustment print can be performed without the thickness entry.
- To change the setting, change the values or settings and then click [Update] button.
- Multiple settings can be changed at once.
- *1 This function is available for VJ-626UF/XPJ-661UF/1462UF.
- *2 This function is available for flat mode.
- *3 This function is available for rotary mode.
- *4 This function is available for XPJ-461UF/XPJ-661UF.
- *5 This function is available for XPJ-1462UF.

13.3.4.4. Media Type Copy

The selected user type settings can be copied to other user type.

The settings which can be copied are as follows:

Print Mode / Effect / set values for Adjust Print / PF Adjustment values / Vacuum Fan / Media Setting

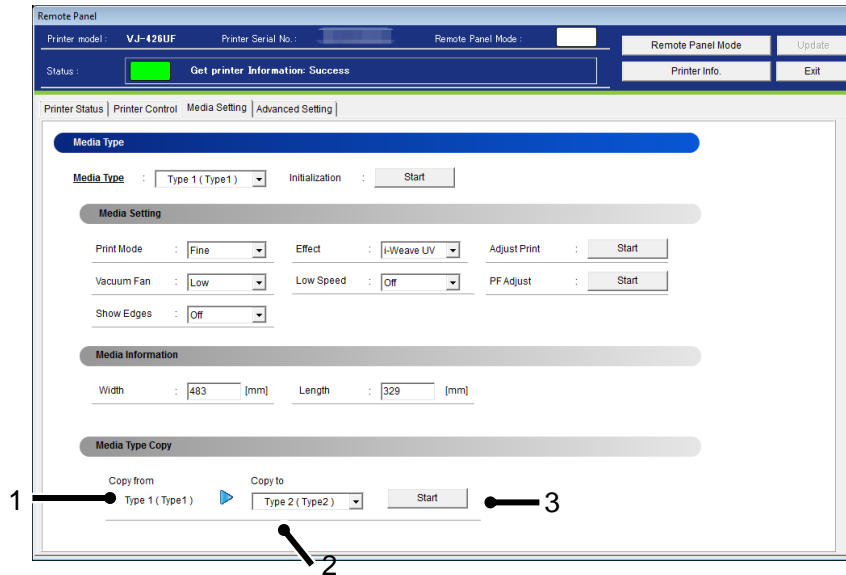

No.	Name	Description
1	Copy from	The selected Media Type is displayed.
2	Copy to	Select a Media Type that you want to copy to. All the Media Types other than the source Media Type can be selected. e.g.: If "User Type 1" is selected, the available copy destination will be User Type 2-10 or ALL.
3	Start	Start copying the setting.

NOTE

- Once the setting of copy destination is changed, it cannot restore to the original setting.

13.3.5 Advanced Setting

Check and change the advanced setting set in the printer.

From this menu, user can check the initial printer settings, and initialize the each setting to factory default.

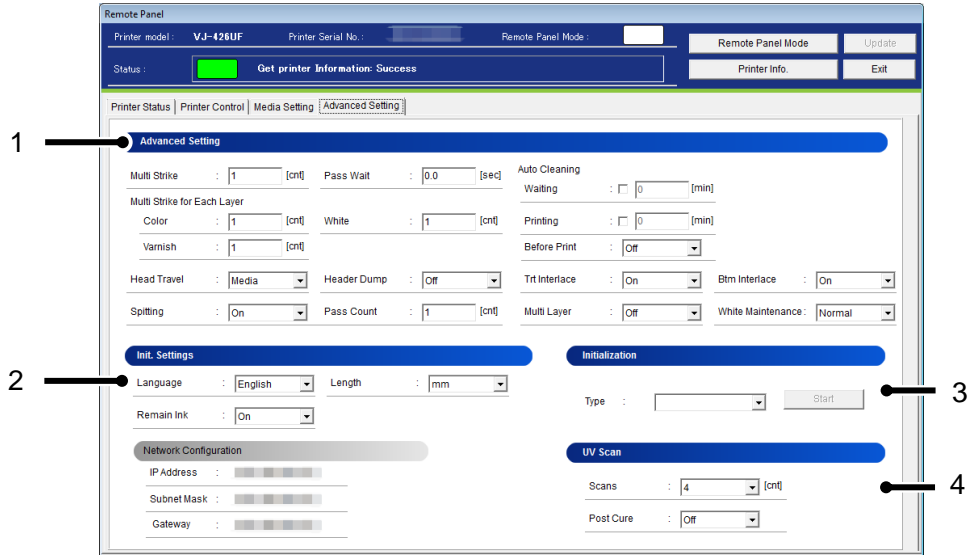

No.	Name	Description
1	Advanced Setting	Check and change the advanced setting set in the printer.
2	Init. Setteings	Initial printer settings including network configuration are displayed.
3	Initialization	Initialize the each setting to factory default.
4	UV Scan	Check and change the UV Scan setting set in the printer.

13.3.5.1. Advanced Setting

Check and change the advanced setting set in the printer.

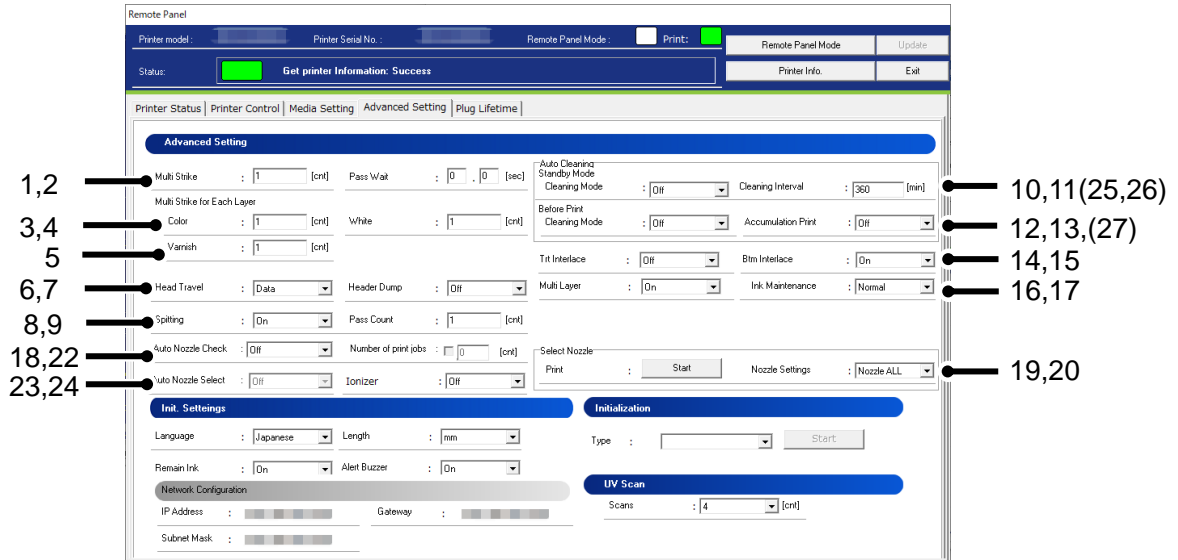

No.	Name	Description
1	Multi Strike	Set the overwrite count per line. Setting : < 1 Cnt > ~ 9 Cnt
2	Pass Wait	Set the waiting time while overwrite printing. Setting : < 0.0 sec > ~ 0.1 sec ~ 5.0 sec
3	Multi Strike for Each Layer (Color)	Set the overwrite count for layer printing (Color) per line. Setting : < 1 Cnt > ~ 9 Cnt
4	Multi Strike for Each Layer (White)	Set the overwrite count for layer printing (White) per line. Setting : < 1 Cnt > ~ 9 Cnt
5	Multi Strike for Each Layer (Varnish)	Set the overwrite count for layer printing (Varnish) per line. Setting : < 1 Cnt > ~ 9 Cnt
6	Head Travel	Set the range that the print head moves while printing. Setting : Data / Machine / < Media Width >
7	Header Dump *2	This function is to specify whether to print the following information (dump data) of print data. The dump data will be used as a reference material to receive technical supports. Setting : < Off > / On / DUMP
8	Spitting	Set the spitting operation while printing. Setting : < On > / Off

No.	Name	Description
9	Pass Count	Set the frequency (Pass Count) that the print head returns to the spitting box (located) on the origin side when setting "On" in the Spitting menu. Setting : < 1 Cnt > ~ 999 Cnt
10	Auto Cleaning - Wait Time *8	Set the time for auto-cleaning in WaitingTime mode. Setting : <Off> ~ 10 min ~ 1440 min
11	Auto Cleaning - Before Print *8	Set the value for auto-cleaning in pre-printing mode. Setting : < Off > / On
12	Auto Cleaning - Printing Time *8	Select the time for auto-cleaning while printing. Setting : < Off > ~ 5 min ~ 180 min
13	Auto Cleaning - Accumulation Paint	Set the time for auto-cleaning in accumulation mode. Setting : <Off> ~ 1[h] / 2[h] / 3[h] / 4[h]
14	Top Edge Treatment *1	Check and change the Top Edge Treatment in the printer. Setting : Off / < On >
15	End Edge Treatment *1,6	Check and change the End Edge Treatment Layer in the printer. Setting : Auto / < On >
16	Multi Layer *2	Check and change the Multi Layer in the printer. Setting : < Off > / On
17	White Maintenance *3,8	Check and change the White Maintenance in the printer. Setting : < Normal > / Little
17	Ink Maintenance *4,5,7	Check and change the Ink Maintenance in the printer. US11/4Color Setting : < Normal > / Long US11/6Color Setting : Little / < Normal > / Long UH21/4Color Setting : Not available (this menu is hidden) UH21/6Color Setting : Little / < Normal >
18	Cleaning Mode *4	Check and change the cleaning mode in the printer. Setting : Short / < Normal > / Long
19	Select Nozzle – Print *2,4,8	Print the nozzle select pattern.
20	Nozzle Settings *2,4,7	Check and change the nozzle settings in the printer. XPJ-1462UF Setting : < Nozzle All > / Nozzle A / Nozzle B / Nozzle C / Nozzle D / Nozzle E / Nozzle F Setting : < Nozzle All > / Nozzle A / Nozzle B / Nozzle C / Nozzle D
21	Auto Nozzle Check *7	Check and change the Auto Nozzle Check Treatment in the printer. Setting : < Off > / On
22	Number of print jobs *7	Check and change the Numver of print fobs Treatment in the printer. Setting : < Off > / 1 – 30 [Cnt]

No.	Name	Description
23	Auto Nozzle Select *7	Check and change the Auto Nozzle Select Treatment in the printer. Setting : Off / < On >
24	Ionizer *7	Check and change the Ionizer Treatment in the printer. Setting : < Off > / On
25	Auto Cleaning - Standby Mode Cleaning Type *7	Select the cleaning type to be performed automatically during standby mode. Setting : < Off > / Short / Normal / Long
26	Auto Cleaning - Standby Mode Cleaning Interval *7	Set the time for auto-cleaning in WaitingTime mode. Setting : 10 min ~ < 360min> ~ 1440 min
27	Auto Cleaning - Before Print Cleaning Interval *7	Set the value for auto-cleaning in pre-printing mode. Setting : < Off > / Short / Normal / Long

NOTE

- *1 This function is available for VJ-426UF.
- *2 This function is available for flat mode.
- *3 This function is available for VJ-426UF/626UF.
- *4 This function is available for XPJ-416UF/661UF.
- *5 Available settings vary depending on the type of ink and ink configuration in the printer.
- *6 This function is available for XPJ-416UF.
- *7 This function is available for XPJ-1462UF.
- *8 This function is not available for XPJ-1462UF.

13.3.5.2. Init. Settings

User can check the initial printer settings.

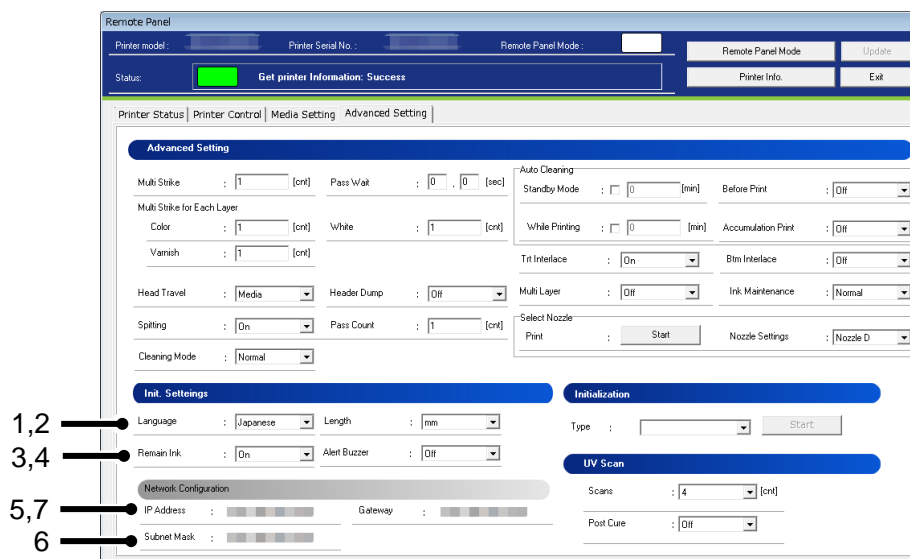

No.	Name	Description
1	Language	Check and change the Language in the printer. Setting : < English > / Japanese XPJ-1462UF Setting : < English > / Dutch / Spanish / French / Italian / Portuguese / German / Japanese
2	Length	Check and change the Length in the printer. Setting : < mm > / inch
3	Remain Ink	Set whether to display the remaining ink amount. Setting : Off / <On>
4	Alert Buzzer	Check and change the alert buzzer setting. Setting : < On > / Off
5	IP Address	Displays the printer IP address.
6	Subnet Mask	Displays the subnet mask of the printer.
7	Gateway	Displays the gateway of the printer.

NOTE

- To change the network configuration, use "MUTOH LFP Finder" (bundled application) or set from the printer panel.
- If the older F/W is used, the setting updates may not be reflected. Install the latest F/W.

13.3.5.3. Initialization

Returns the settings of the printer to default.

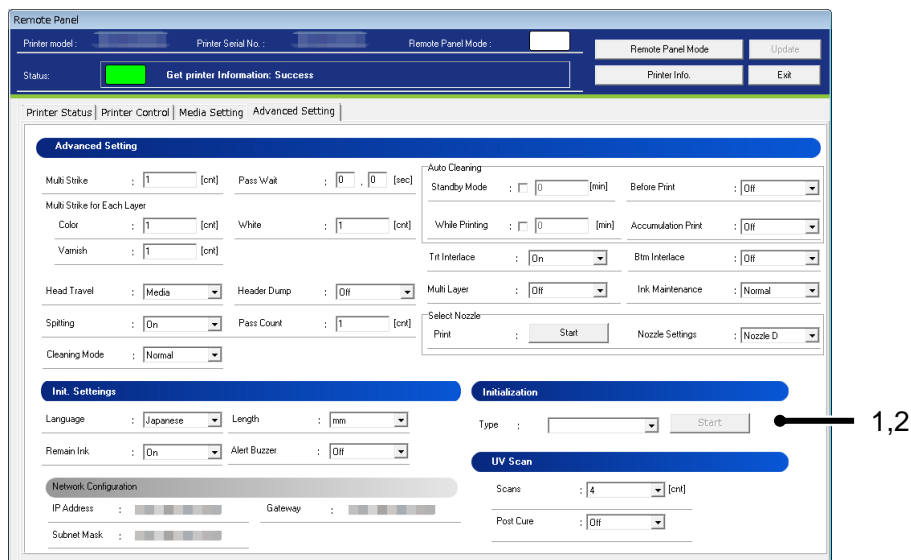

No.	Name	Description
1	Type	<p>ALL :</p> <p>All settings can be returned to factory default.</p> <p>Media Type :</p> <p>The setting of the Media Type is returned to factory default.</p> <p>Advanced Setting :</p> <p>Advanced setting is returned to factory default.</p> <p>Init. Setting :</p> <p>Initial setting is returned to factory default.</p>
2	Start	Initialize the selected setting to the factory default.

NOTE

- To change the network configuration, use "MUTOH LFP Finder" (bundled application) or set from the printer panel.

13.3.5.4. UV Scan

Check and change the UV Scan setting set in the printer.

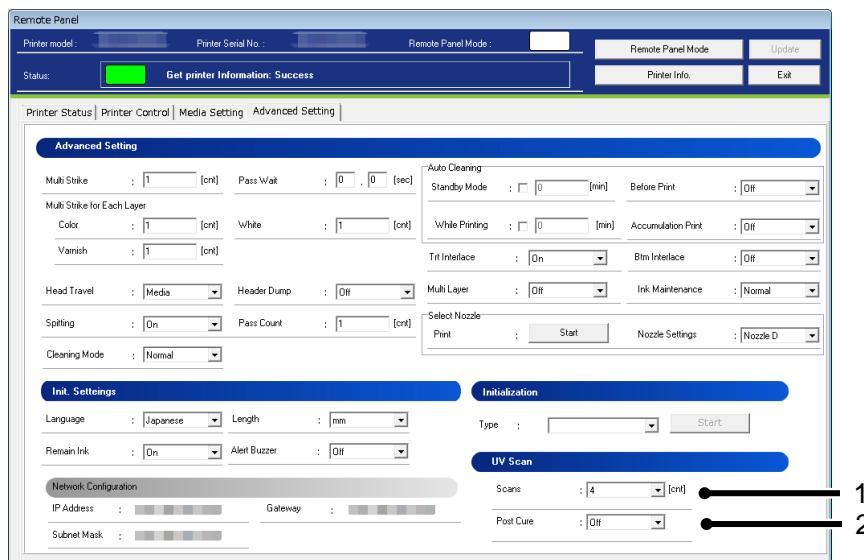

No.	Name	Description
1	Scans	Specify the number of UV scan after printing per 1 inches (in media feeding direction). Setting : 2 / < 4 > / 8 / 16
2	Post Cure *1	Specify whether to automatically perform the UV curing after printing. Setting : < Off > / On

NOTE

- If the older F/W is used, the setting updates may not be reflected. Install the latest F/W.
- *1 This function is not available for XPJ-1462UF.

13.3.6 Plug Lifetime

Check and initialize the plug lifetime counter on the high-capacity ink pack adaptor.

13.3.6.1. Reset Plug Lifetime Counter

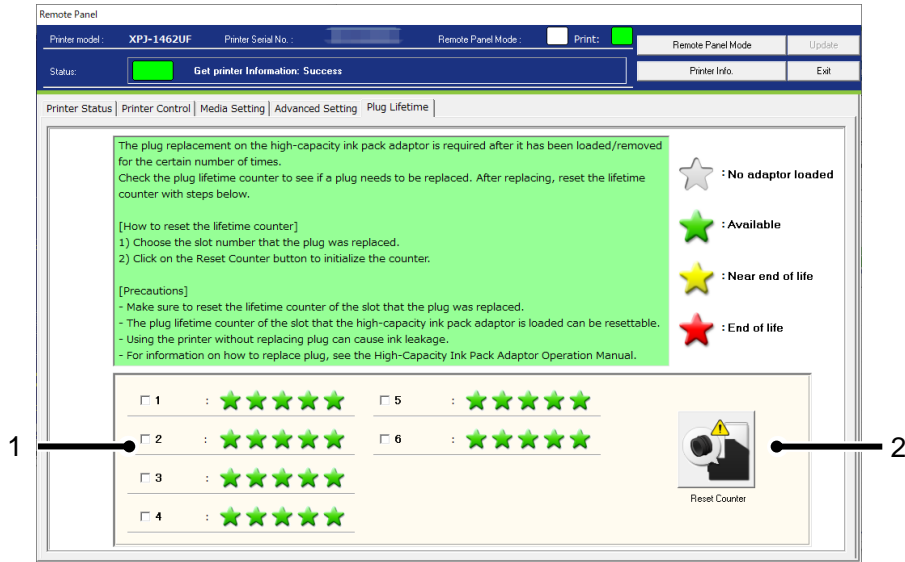

No.	Name	Description
1	Plug Lifetime	<p>Indicate the plug life status of each slot. *Only when the high-capacity ink pack adaptor is loaded, the status bar is enabled.</p> <p> : No adaptor loaded : Available (100~81%) : Available (80~61%) : Available (60~41%) : Available (40~21%) : Near end of life (20%~1%) : End of life (0%) </p>
2	Reset Counter	Initialize the plug lifetime counter of the selected slot.

NOTE

- If no high-capacity ink pack adaptor is loaded, this menu will not be displayed.
- For information on how to replace the plug, see the High-Capacity Ink Pack Adaptor Operation Manual.
- This function is not available for XPJ-1462UF.

13.3.6.2. Confirmation

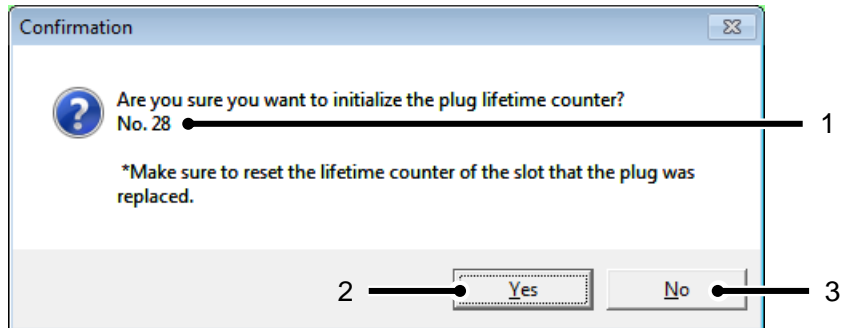



No.	Name	Description
1	Slot No.	The slot number of the plug lifetime counter to be initialized is displayed.
2	Yes	Initialize the counter.
3	No	Cancel the initialization.

13.4. XPJ-1641SR/1682SR/16x2WR/1341xR-P/1641SR-P/1682SR-P/HA-1642

13.4.1 Remote Panel

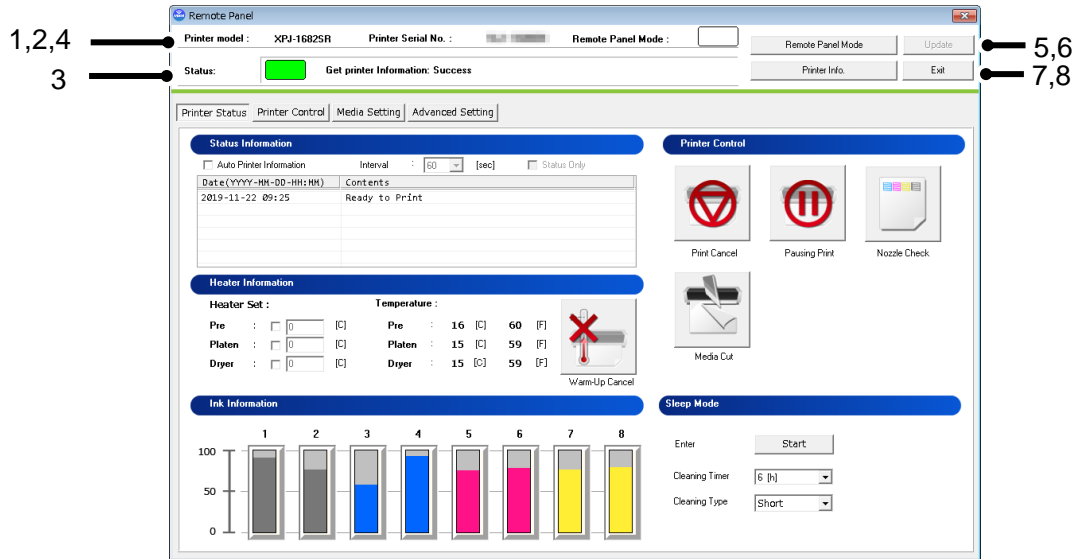
Check the printer information and the remote panel status.



No.	Name	Description
1	Printer model	Displays the selected printer model.
2	Printer Serial No.	Displays the printer serial number.
3	Status	Displays the remote panel status.
4	Remote Panel Mode(Status)	Displays current remote panel mode from:  Remote Panel Mode On  Remote Panel Mode Off
5	Remote Panel Mode Button	Enable/Disable remote panel mode.
6	Update	Change the printer settings.
7	Printer Information button	Get current panel setting information from your printer. *Printer information of the selected tab is obtained.
8	Exit button	Exit the Remote Panel menu.

13.4.2 Printer Status

Displays the printer status and remotely operate the printer.

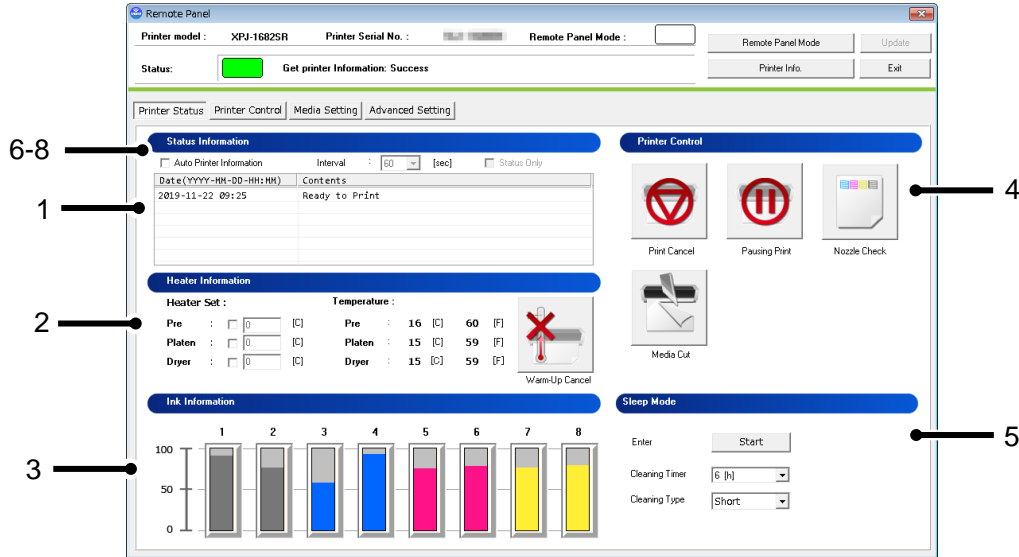

No.	Name	Description
1	Status Information	Displays the current printer status. If the printer encounters a system error, a workaround will be displayed.
2	Heater Information *1,2	Check and change the heater temperature. * The Heater Set temperature is reflected from: Media Setting tab > Media Type > Media Setting > Heater. When the printer is warming up, you can cancel the warm-up and start printing.
3	Ink Information	The remaining ink amount of the printer is displayed. For the details of S/C card recovery, see 7.7.2 S/C Card Recovery.
4	Printer Control	Remotely perform the following operations: •Print Cancel •Pausing Print •Media Cut •Nozzle Check
5	Sleep Mode	Remotely switch the printer to Sleep Mode.
6	Auto Printer Information	Check this box to automatically get printer information. On : Enable Off : Disable *This function is not available when MSM is launched from the Windows printer driver.
7	Interval	When “Auto Printer Information” is ON, set a time interval to get the latest information from the printer. Value can be set from: <60[sec]> / 30[sec] / 10[sec] / 3[sec]
8	Status Only	Check this box to obtain the printer status information only to minimize the data acquisition time. *This check box is enabled when “Auto Printer Information” is set to ON.

NOTE

- *1 This function is available for XPJ-1682SR / 1641SR / 1341SR-P/ 1641SR-P.
- *2 This function is available for XPJ-1642WR.

13.4.2.1. Heater Information

Check and change the heater temperature.

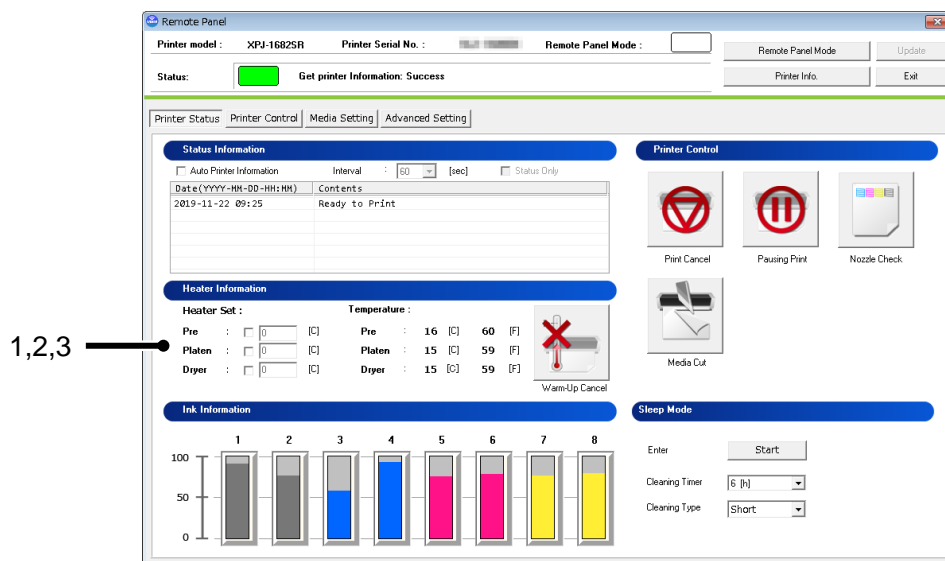

No.	Name	Description
1	Heater : Heater Set	Check and change the heater temperature for the media.
2	Heater : Temperature	The actual temperature of each heater will be displayed.
3	Warm-up Cancel	When the printer is warming up, you can cancel the warm-up and start printing.

13.4.2.2. Sleep Mode

Remotely switch the printer to Sleep Mode.

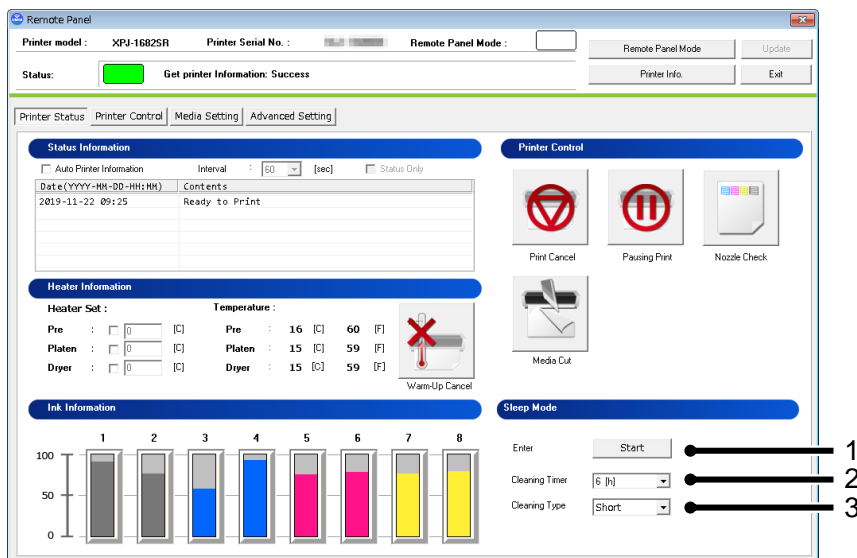

No.	Name	Description
1	Enter	Enter/Wake up from Sleep Mode.
2	Cleaning Timer	Set the cleaning timer during Sleep Mode. Setting : 1 / 2 / 3 / 4 / 5 / <6> / 9 / 12 / 18 / 24 [h]
3	Cleaning Type *1	Set the cleaning type during Sleep Mode. Setting : Short / Normal / Long XPJ-1641SR-P Setting : Short / Normal / Long / < Flushing >

NOTE

- *1 This function is available for non-XPJ-1341SR-P/1341WR-P.

13.4.3 Printer Control

Remotely operate the printer.

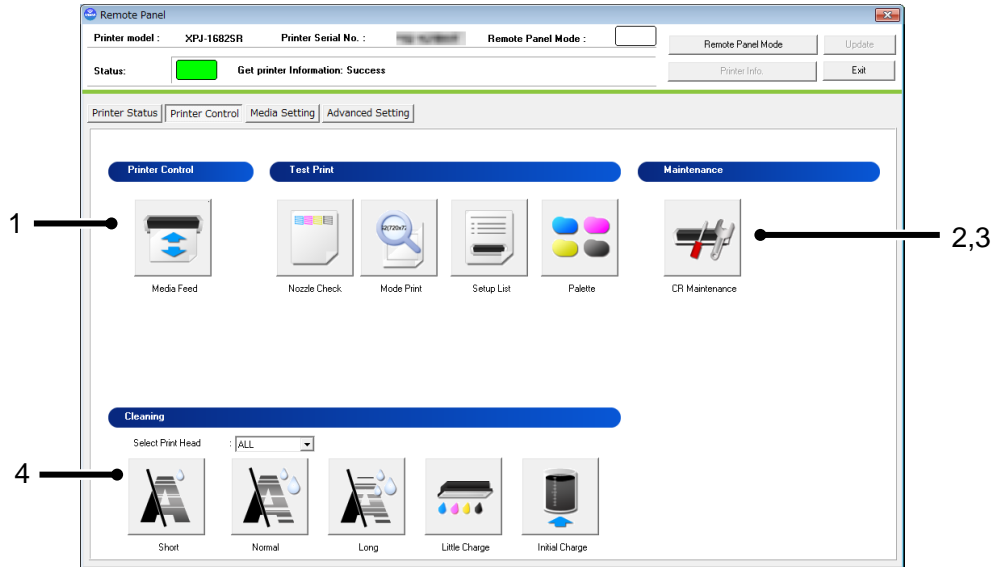

No.	Name	Description
1	Printer Control	Remotely operate the printer.
2	Test Print	Perform the test print selected from this menu.
3	Maintenance	Perform the maintenance selected from this menu.
4	Cleaning	Perform the cleaning selected from this menu.

13.4.3.1. Printer Control

Remotely operate the printer.

(1)Media Feed

Specify the feeding amount of media set in the printer and feed it in forward/ backward with the specified amount.

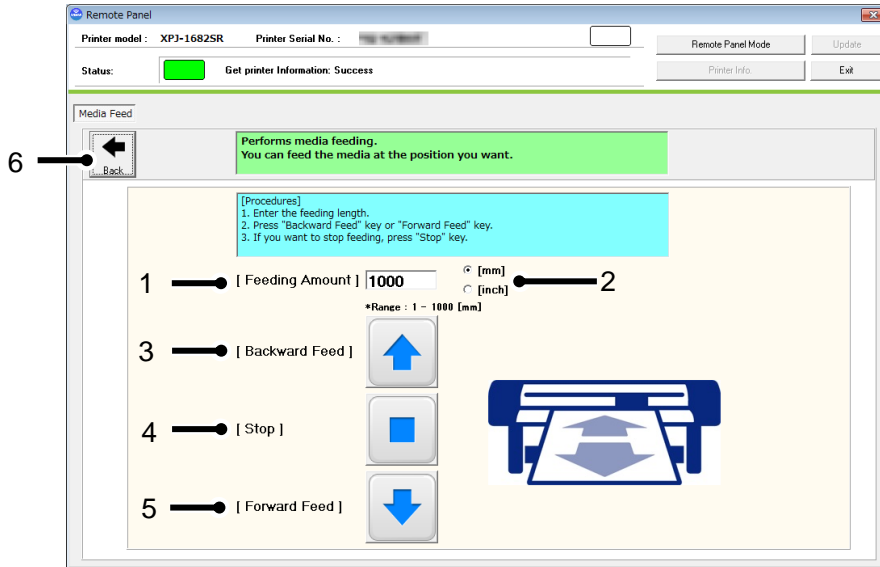

No.	Name	Description
1	Feeding Amount	Specify the media feeding amount range between: • In [mm] setting: 1 ~ < 1000 mm > (in increments of 1 mm) • In [inch] setting: 0.04 ~ < 39.37 inch > (in increments of 0.01 inch)
2	Unit of Feeding Amount	Select the unit of feeding amount from: <mm> or inch
3	Backward Feed	Feed the media backward with the specified amount.
4	Stop	Stop the media feeding.
5	Forward Feed	Feed the media forward with the specified amount.
6	Back	Go back to the Printer Control Main Menu.

<> Default setting

NOTE

- The printer will feed the media according to the setting you specified. Make sure to specify the appropriate amount to prevent unwinding.

13.4.3.2. Test Print

Perform the test print selected from the menu.

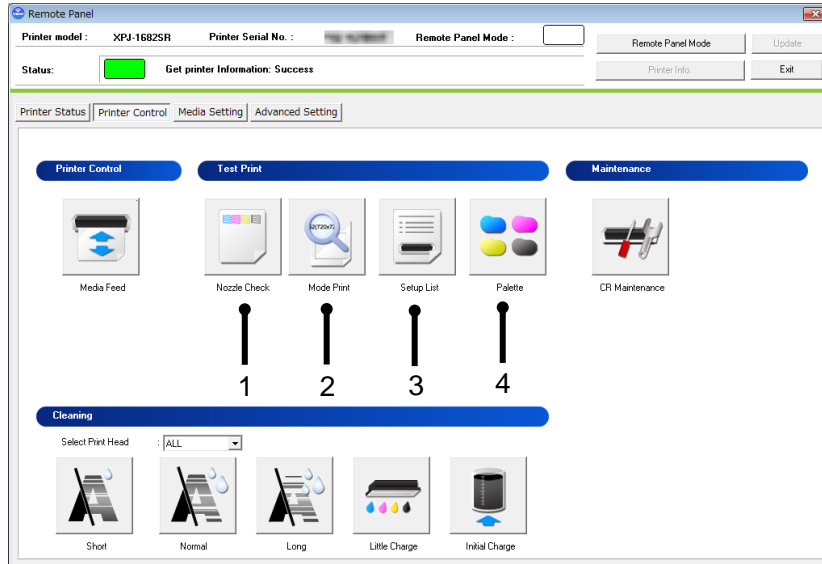

No.	Name	Description
1	Nozzle Check	Print the nozzle check pattern.
2	Mode Print	Print the printing conditions.
3	Setup List	Print the current printer setup list.
4	Palette	Print the palette pattern. *In some print modes, this menu is not available.

13.4.3.3. Maintenance

Remotely perform printer maintenances.

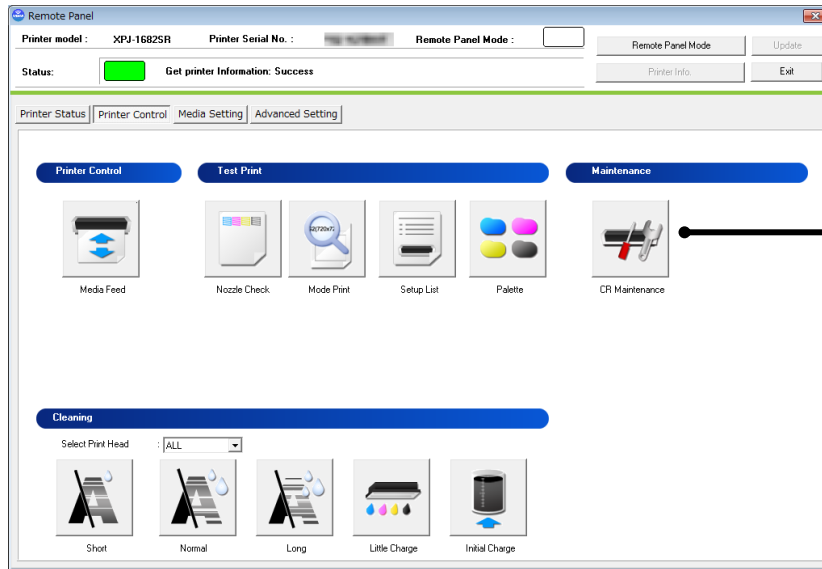

No.	Name	Description
1	CR Maintenance	Remotely perform CR Maintenances.

(1)CR Maintenance

1-1)Check Printer Status

Before performing CR maintenance, check the printer status.

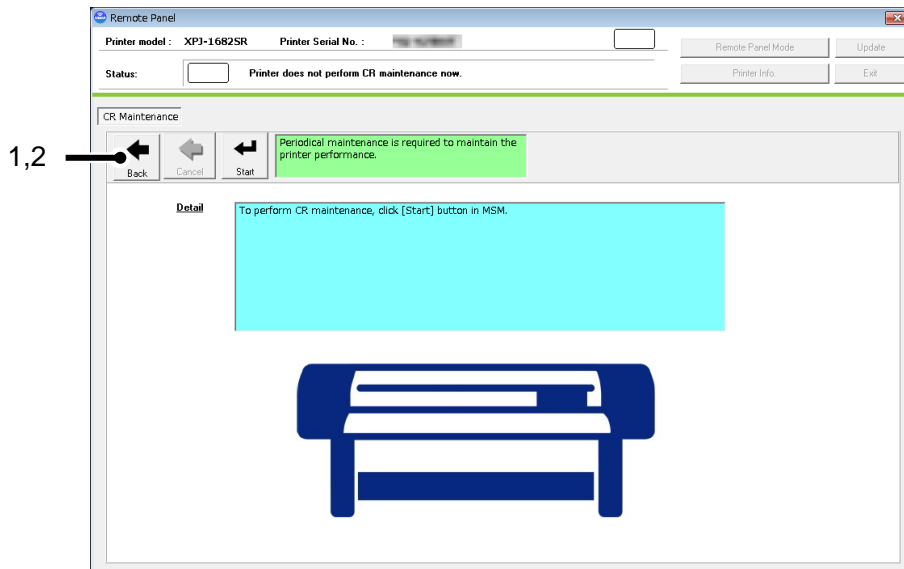

No.	Name	Description
1	Back	Go back to the Printer Control Main Menu.
2	Start	Instruct the printer to perform CR Maintenance.

CR maintenance is being performed in the printer.

Please press Operation key on the printer panel to complete CR maintenance.

1-2) Waiting to press [Operation] button in printer.

Before performing CR maintenance, press Operation key on the printer panel and then start CR maintenance.

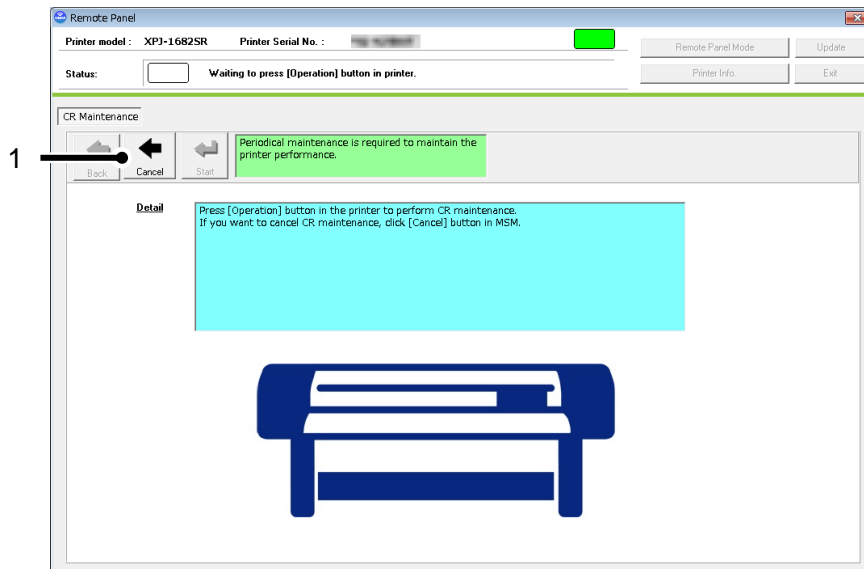

No.	Name	Description
1	Cancel	Cancel to perform CR maintenance.

NOTE

- Before starting CR maintenance, make sure to press Operation key on the printer panel.

1-3) Performing CR maintenance

CR maintenance is being performed in the printer.

After CR maintenance is completed, press Operation key on the printer panel.



No.	Name	Description
1	Back	Go back to the Printer Control Main Menu.
2	Detail	CR maintenance elapsed time is displayed.

NOTE

- After CR maintenance is completed, make sure to press Operation key on the printer panel.

(2) Longstore

Wash the print head with the cleaning fluid.

NOTE

- Make sure to use the dedicated cleaning fluid.

1) Start LongStore

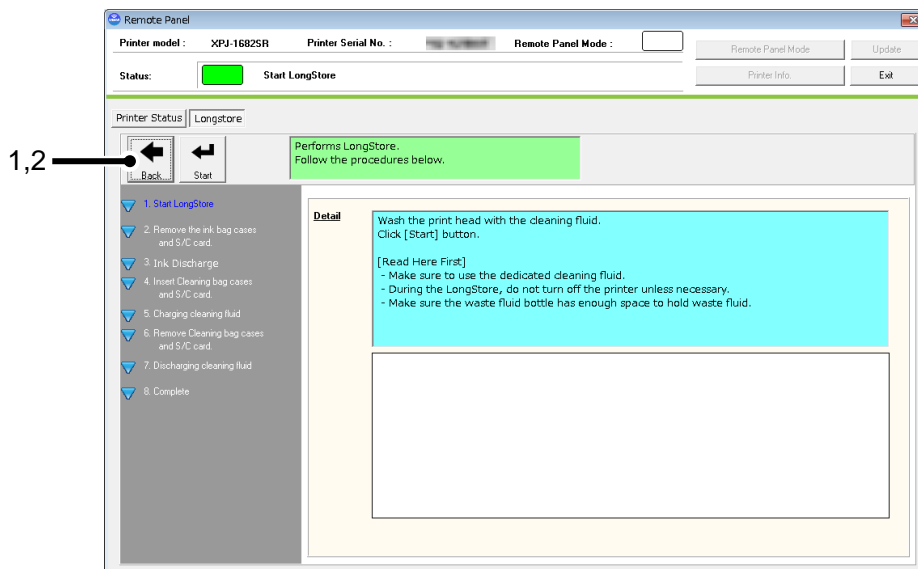

No.	Name	Description
1	Start	Start LongStore.
2	Back	Go back to the Printer Control Main Menu.

2) Remove ink bag cases and S/C card.

This message is displayed when any ink bag cases and S/C card is inserted in the printer.

If no ink bag cases and S/C card is inserted, this message will be skipped.

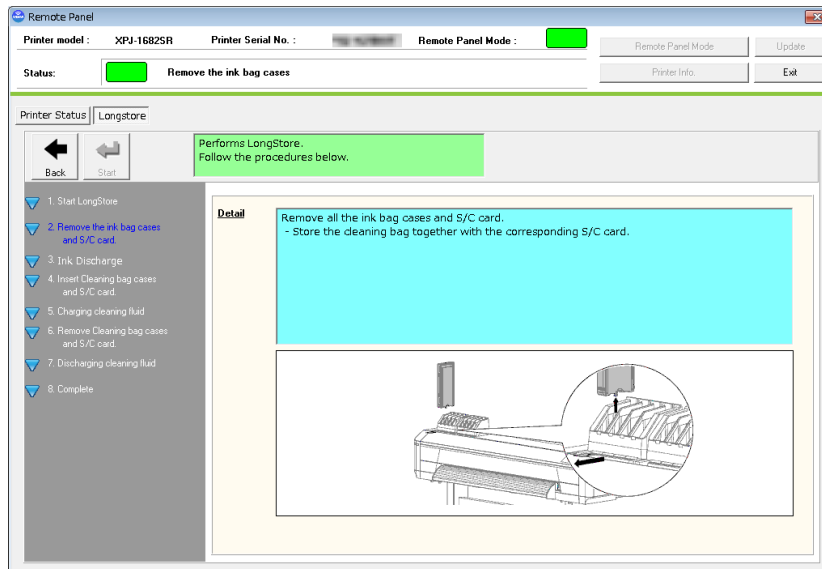

3) Ink discharge.

After removing the cleaning bag cases and S/C card, the printer will ink discharge.

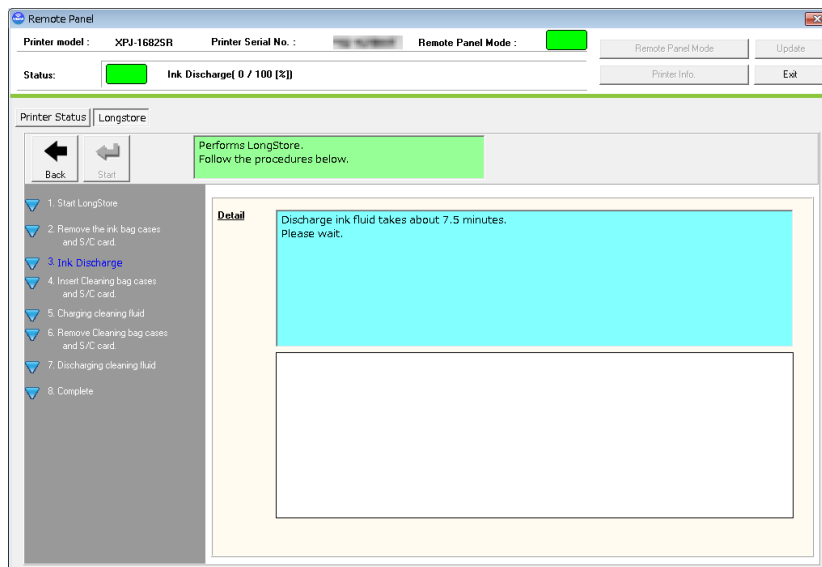

4) Insert Cleaning bag cases and S/C card.

Insert cleaning bag cases and S/C card to all the slots.

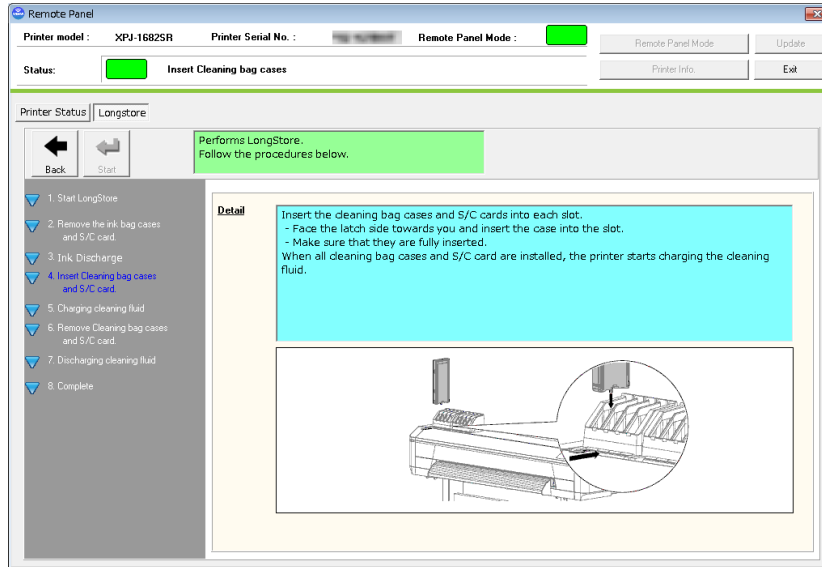

5) Charging cleaning fluid

After the cleaning bag cases and S/C card are inserted into the slots, the printer will start charging cleaning fluid.

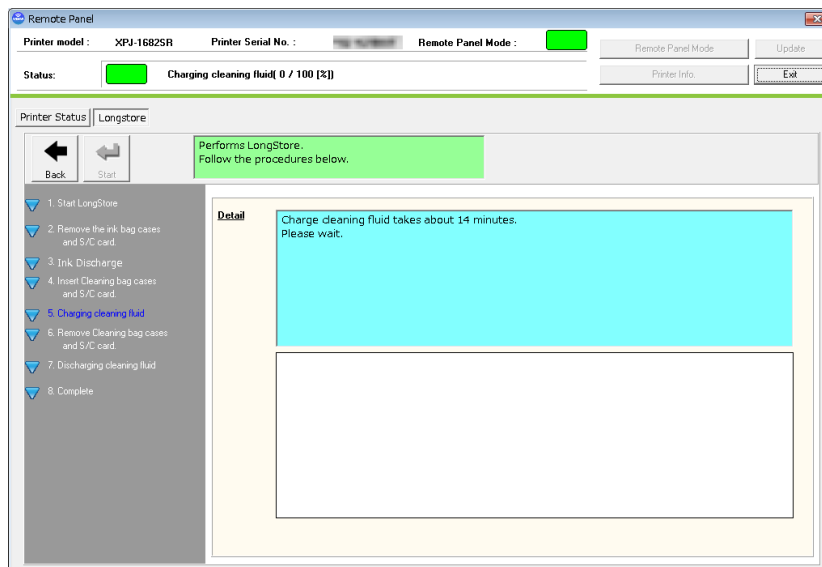

6) Remove cleaning bag cases and S/C card

After charging fluid, remove all the cleaning bag cases and S/C card.

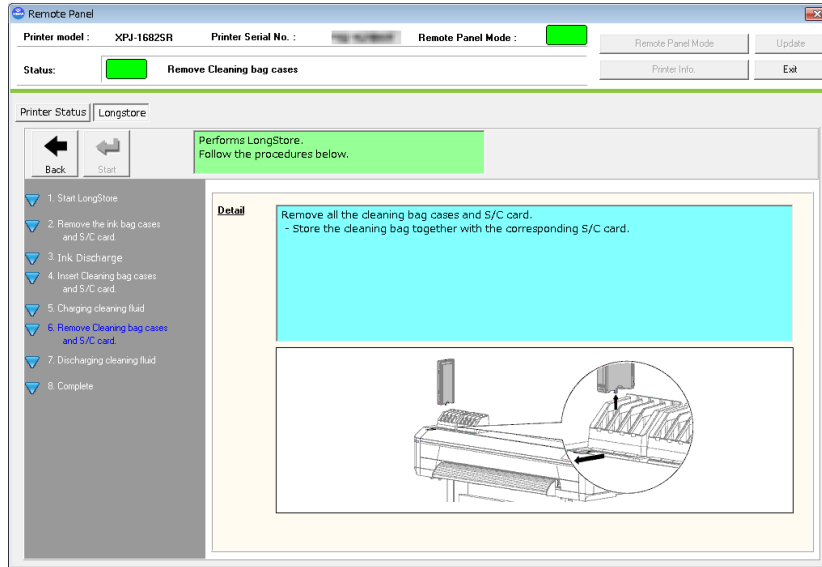

7) Discharging cleaning fluid

After removing the cleaning bag cases and S/C card, the printer will discharge cleaning fluid.

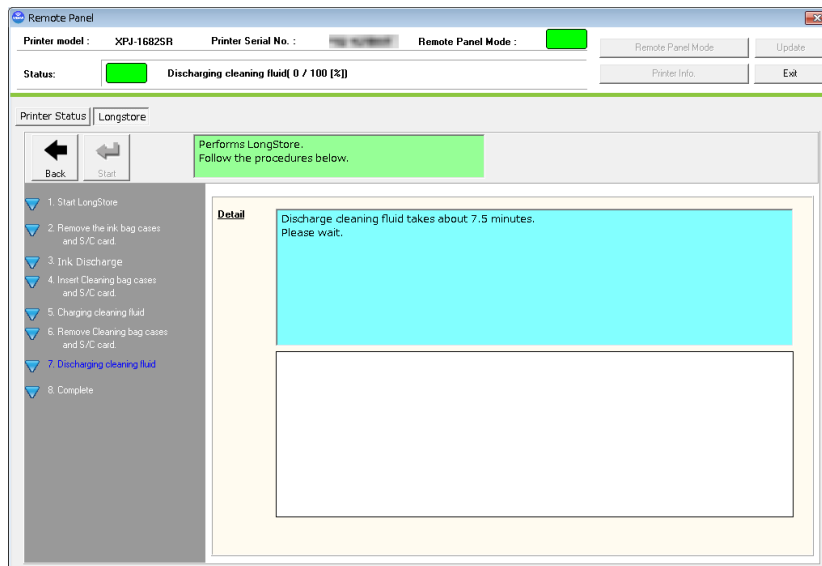

8) Complete

“Longstore” maintenance has been completed.

Restart the printer and perform initial ink charge.

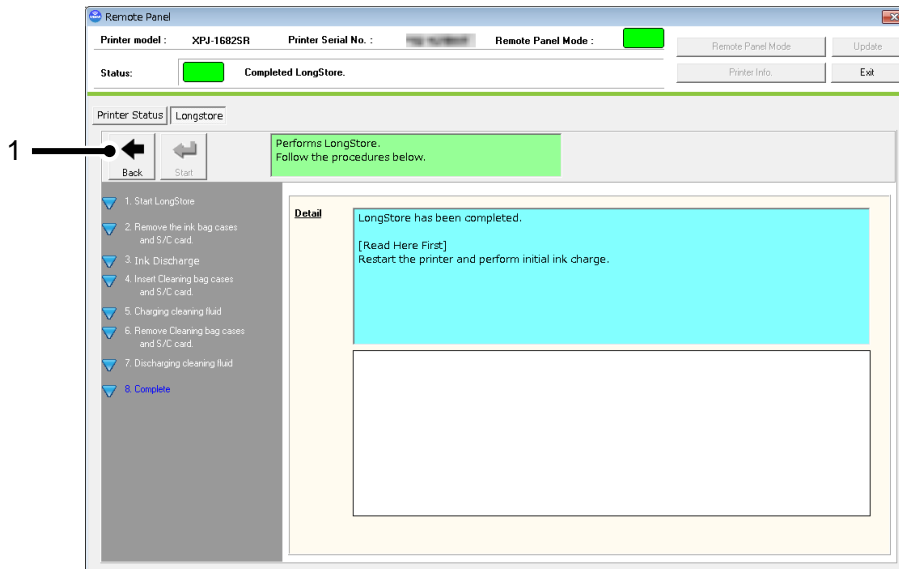

No.	Name	Description
1	Back	Go back to the Printer Control Main Menu.

13.4.3.4. Cleaning

Performs head cleaning.

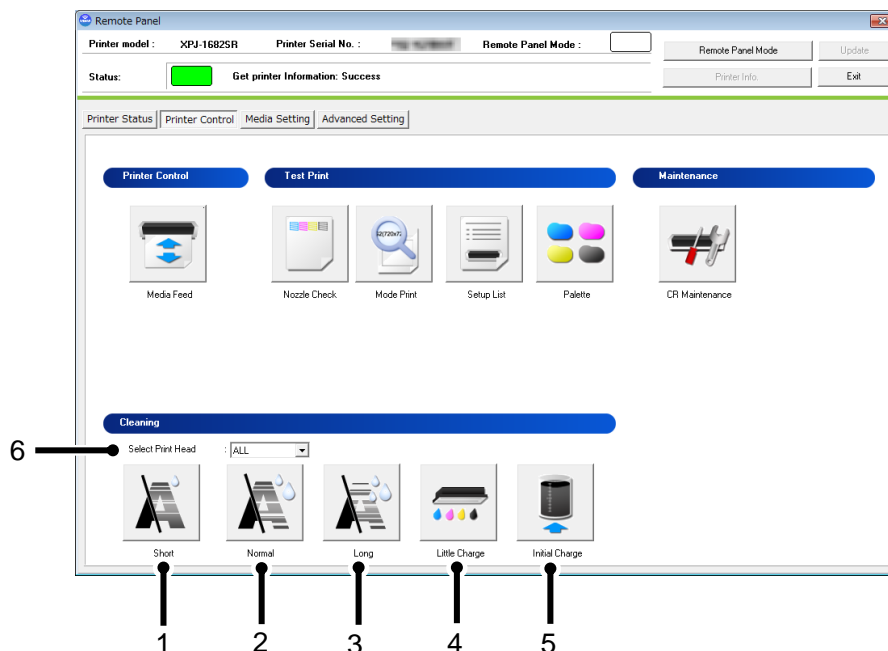

No.	Name	Description
1	Short Cleaning *1	Discharges smaller amount of ink compared to "Normal".
2	Normal Cleaning *1	Select this mode normally.
3	Long Cleaning *1	Discharges larger amount of ink compare to "Normal". Used when the print head does not improve by normal Head cleaning.
4	Little Charge *1	Refills a small amount of ink. Charge a small amount of ink when printing is not stable after initial ink charge.
5	Initial Charge	Perform initial ink charge. Refer to the (1)Initial Charge for the details.
6	Select Print Head	Select the print head to be cleaned if the printer has more than one print head. Setting : <ALL> / Head 1 / Head 2

NOTE

- *1 The print head can be selected.
- Do not remove ink cartridges/ink bags during cleaning. Air may enter the ink tubes.

(1) Initial Charge

Perform the initial ink charge after ink cartridges are inserted into the correct slots.

1) Insert Ink bag cases and S/C card

After the counter reset, insert the ink bag cases and S/C card.

After the ink bag cases and S/C card are inserted into the correct slots, the printer will start initial ink charge.

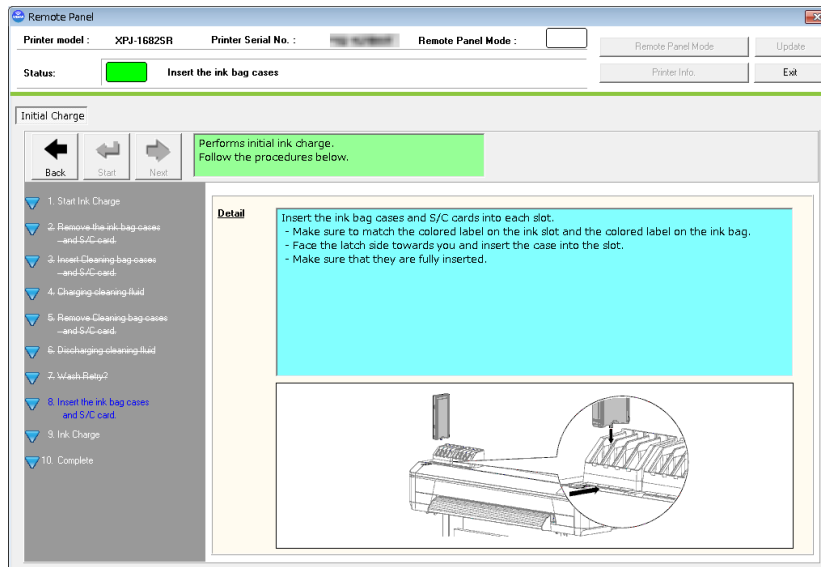

2) Ink Charge

The printer is charging inks.

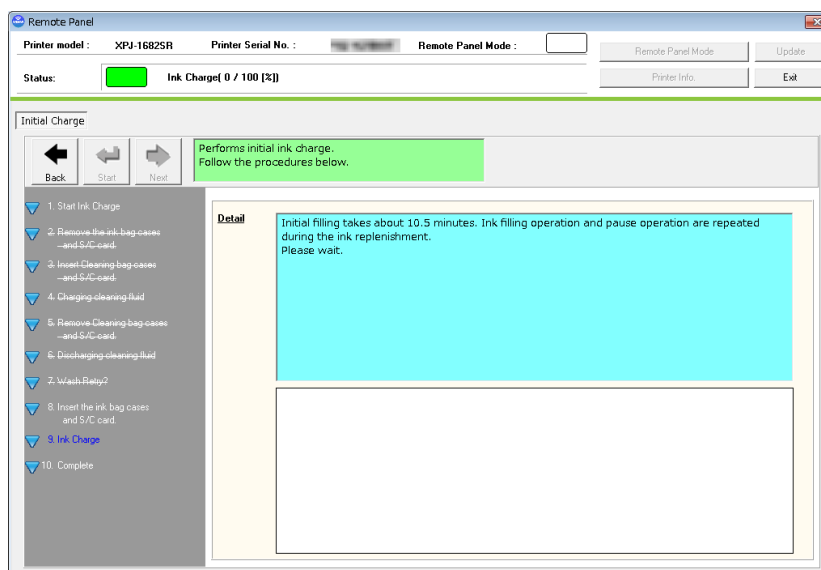

3) Complete

Initial ink charge has been completed.

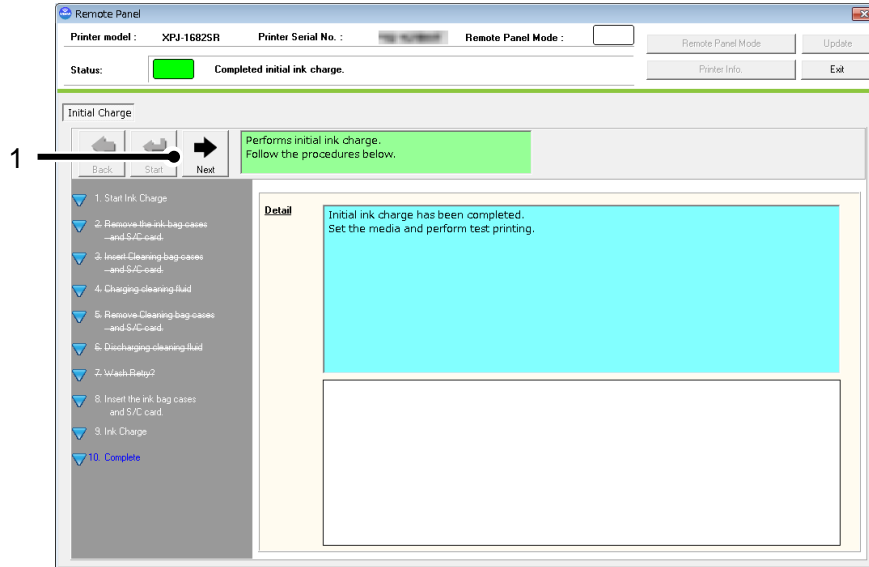

No.	Name	Description
1	Back	Go back to the Printer Control Main Menu.

13.4.4 Media Setting

Check and change the media setting.

If you use more than one media, you can store the each media setting including the heater temperature from this menu.

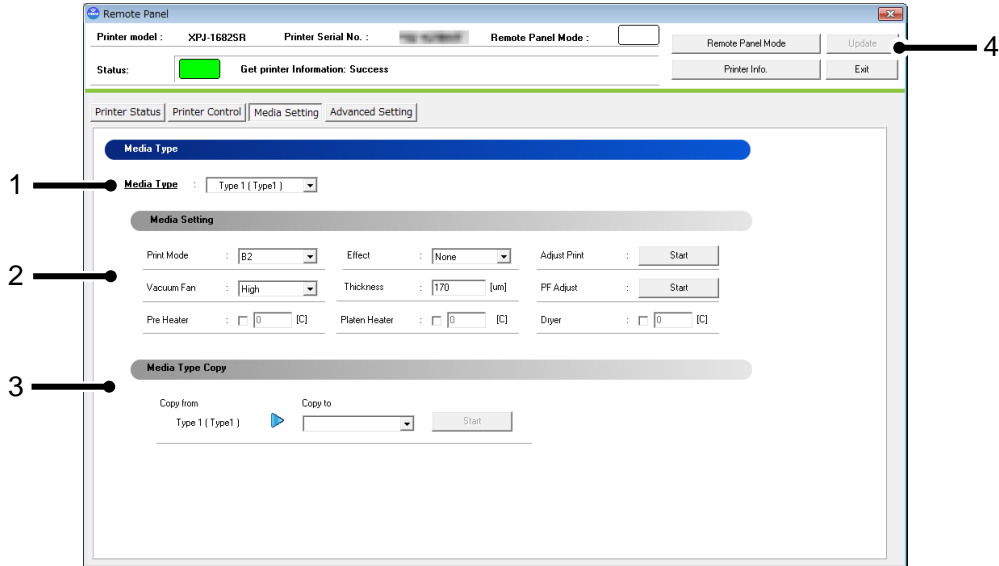

No.	Name	Description
1	Media Type	Check and change the media type loaded in the printer.
2	Media Setting	Check and change the current media setting.
3	Media Type Copy	Copy the current media setting to other Media Type.
4	Update	Change the media setting.
5	Initialization	Initialize the each setting to factory default.

NOTE

- To change the setting, change the values or settings and then click [Update] button.
- Multiple settings can be changed at once.

13.4.4.1. Media Type

Check and change the Media Type loaded in the printer.

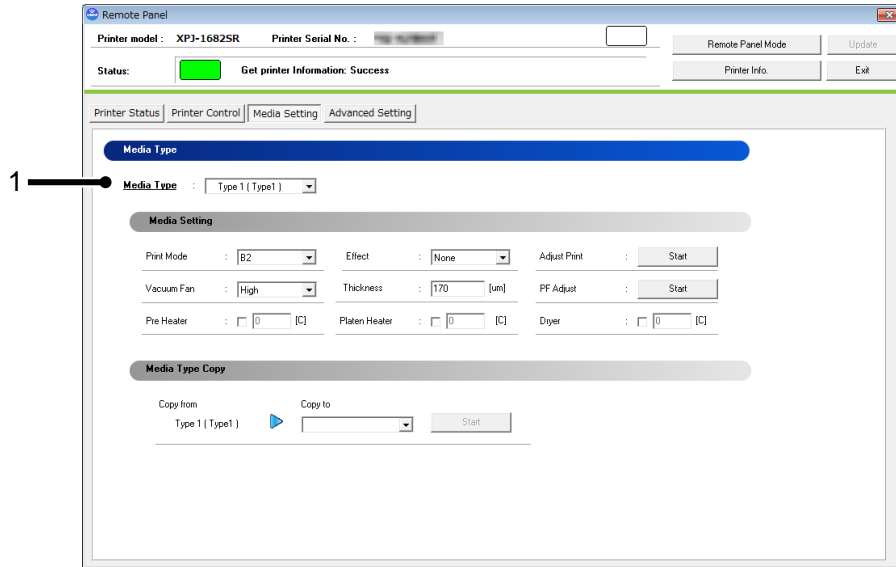

No.	Name	Description
1	Media Type	Check and change the Media Type loaded in the printer.

NOTE

- To change the setting, change the values or settings and then click [Update] button.

13.4.4.2. Media Setting

Check and change the media setting currently loaded in the printer.

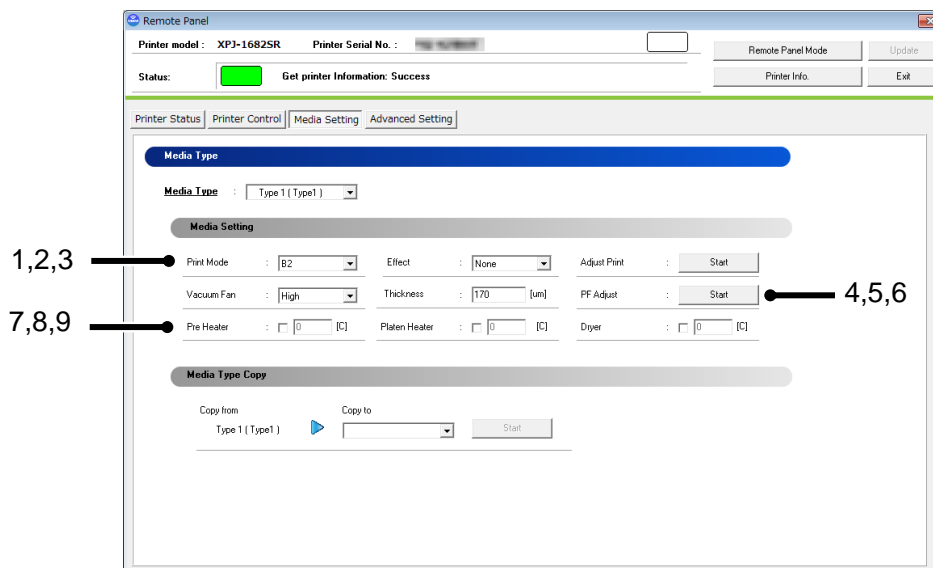

No.	Name	Description
1	Print Mode *3	Check and change the Print Mode of the media. XPJ-1682SR/1682WR/1642WR: Setting : Q1 / Q2 / Q3 / Q4 / G1 / <G2> / B1 / B2 / B3 / B4 XPJ-1641SR: Setting : Q1 / Q2 / Q3 / Q4 / G1 / <G2> / G3 / G4 / B1 / B2 / B3 / B4 XPJ-1341SR-P/1641SR-P/1341WR-P: Setting : High Quality / < Quality > / Production / High Speed
2	Effect *3	Check and change the Effect of the media. XPJ-1682SR/1682WR: Setting : None / Wave / Fine&Fuzz / <Fine&Fog> / A-S.Fine&Wave / B-S.Fine&Wave XPJ-1641SR: Setting : None / Wave / Fog / Fine&Fuzz / <Fine&Fog> / A-S.Fine&Wave / B-S.Fine&Wave XPJ-1642WR: Setting : None / Wave / Fine&Fuzz / <Fine&Fog> / A-S.Fine&Wave / B-S.Fine&Wave / i-Weave Ex / i-Screen XPJ-1341SR-P/1641SR-P/1341WR-P: Setting : None / Wave / Fine&Fuzz / <Fine&Fog> / i-Weave Ex / i-Screen
3	Adjust Print	Perform Bi-D adjustment for the media.

4	Vacuum Fan	<p>Check and change the vacuum fan of the media.</p> <p>XPJ-1682SR/1682WR Setting : Low / Middle / <High> / Ex High</p> <p>XPJ-1642WR Setting : <Off> / Low / Middle / High / Ex High</p> <p>XPJ-1341SR-P/1341WR-P Setting : Off / Low / Middle / <High></p> <p>XPJ-1641SR-P/1682SR-P/HA-1642 Setting : Off / Low / Middle / <High> / Ex High</p>
5	Thickness	<p>Check and change the thickness of media.</p> <p>XPJ-1682SR/1682WR/1641SR: Setting : 80 – <170> – 2800 [μm]</p> <p>XPJ-1642WR: Setting : 40 – <170> – 1000 [μm]</p> <p>XPJ-1341SR-P/1641SR-P/1341WR-P/1682SR-P/HA-1642: Setting : 80 – <170> – 1300 [μm]</p>
6	PF Adjust	Perform the paper feed adjustment of the media.
7	Pre Heater *1	<p>Check and change the pre heater temperature for the media.</p> <p>Setting : Off / <30> – 50 [°C]</p>
8	Platen Heater *1	<p>Check and change the platen heater temperature for the media.</p> <p>Setting : Off / <30> – 50 [°C]</p>
9	Dryer *1,2	<p>Check and change the dryer temperature for the media.</p> <p>Setting : Off / <30> – 50 [°C]</p>

NOTE

- To change the setting, change the values or settings and then click [Update] button.
- Multiple settings can be changed at once.
- *1 This function is available for XPJ-1682SR/XPJ-1641SR/1341SR-P/1641SR-P.
- *2 This function is available for XPJ-1642WR.
- *3 HA-1642 is not supported.

(1) Adjust Print

Perform Bi-D adjustment for the media loaded in the printer.

1) Thickness

Specify the media thickness.

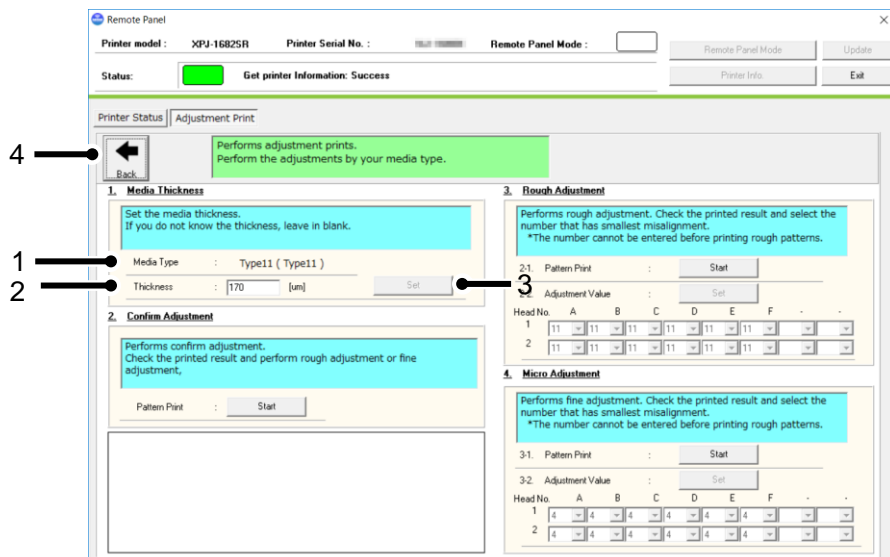

No.	Name	Description
1	Media Type	The Media Type loaded in the printer is displayed.
2	Thickness	Enter the media thickness set in the printer.
3	Set	Set the media thickness to the printer.
4	Back	Go back to the Media Setting Menu.

2) Confirmation

Print the adjustment pattern in the current setting.

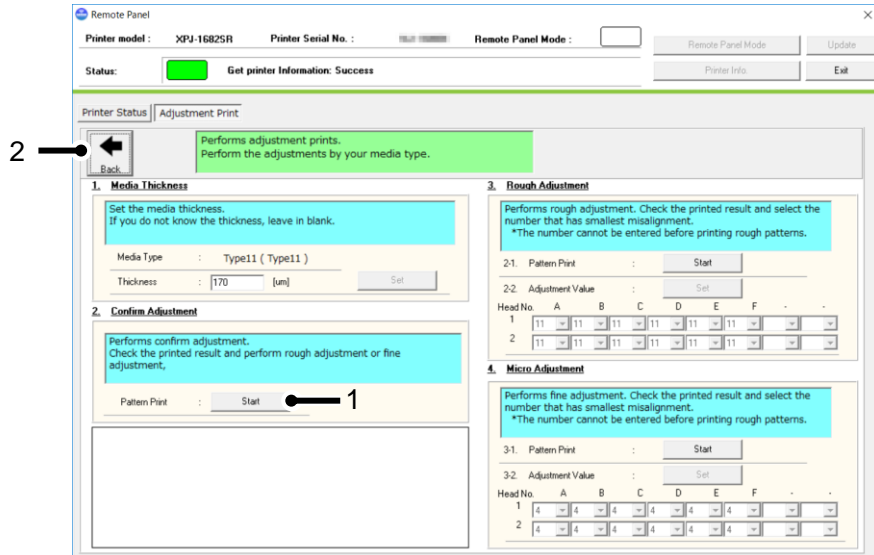

No.	Name	Description
1	Start	Print the adjustment pattern in the current setting.
2	Back	Go back to the Media Setting Menu.

3) Rough Adjustment

Perform rough adjustment.

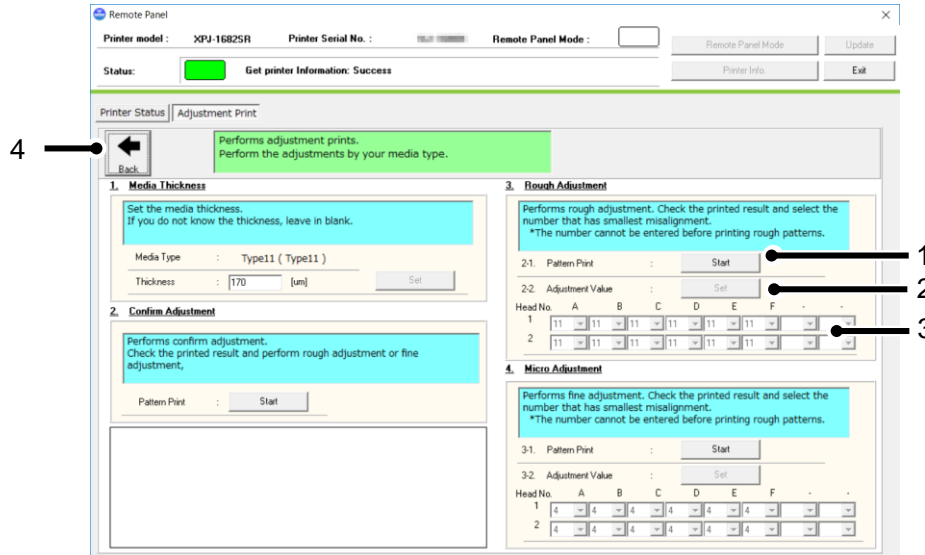

No.	Name	Description
1	Start	Print the rough adjustment pattern.
2	Set	Set the adjustment value to the printer after the value change.
3	Adjustment Value	Change each adjustment value. *Adjustment patterns and adjustment range vary depending on the printer or ink type you use.
4	Back	Go back to the Media Setting Menu.

4) Micro Adjustment

Perform micro adjustment.

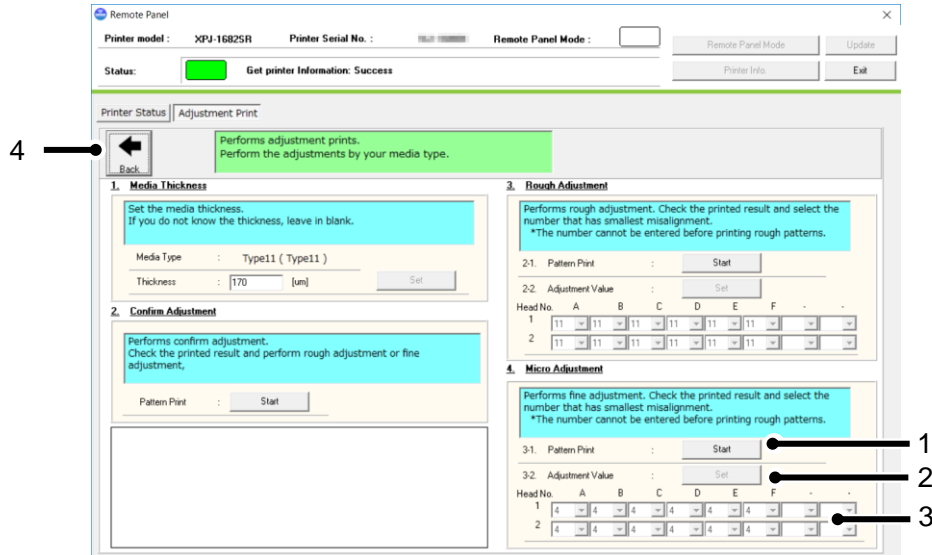

No.	Name	Description
1	Start	Print the rough adjustment pattern.
2	Set	Set the adjustment value to the printer after the value change.
3	Adjustment Value	Change each adjustment value. *Adjustment patterns and adjustment range vary depending on the printer or ink type you use.
4	Back	Go back to the Media Setting Menu.

(2) PF Adjust

Perform the paper feed adjustment.

1) Initial Adjust

Performs initial adjustment.

Click [Start] button to print initial adjustment pattern and measure the distance between the printed two pluses (+)

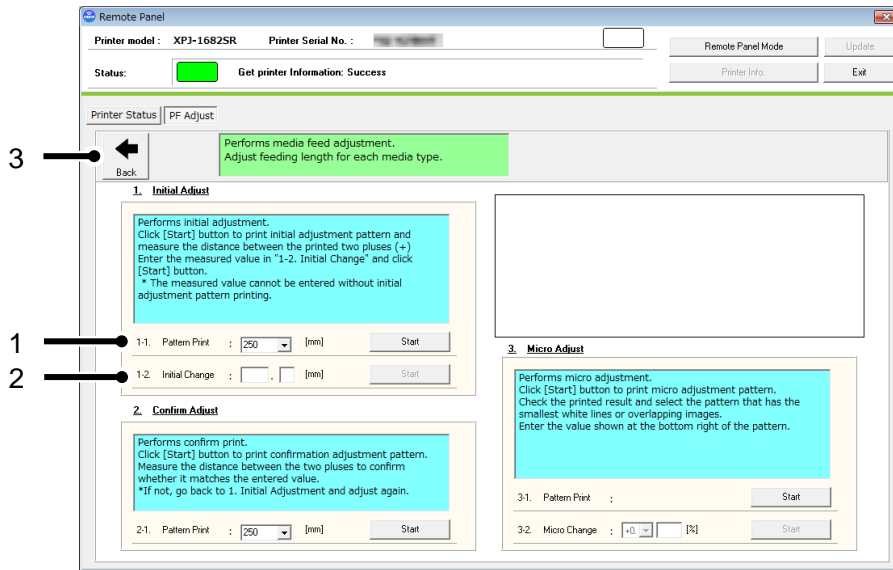

No.	Name	Description
1	Pattern Print - Start	Print the initial PF adjustment pattern. Pattern length : 100 [mm] ~ < 250 [mm] > ~ 500 [mm] (in increments of 50 [mm])
2	Initial Change - Start	Set the initial PF adjustment value to the printer. Adjustable range : ±50.0 [mm] from the initial PF adjustment pattern (in increments of 0.1[mm]). e.g.) If the initial PF adjustment pattern is set to 250[mm], the adjustable range will be 200 [mm] ~ 300 [mm].
3	Back	Go back to the Media Setting Menu.

2) Confirm Adjust

Performs confirm print.

Click [Start] button to print confirmation adjustment pattern.

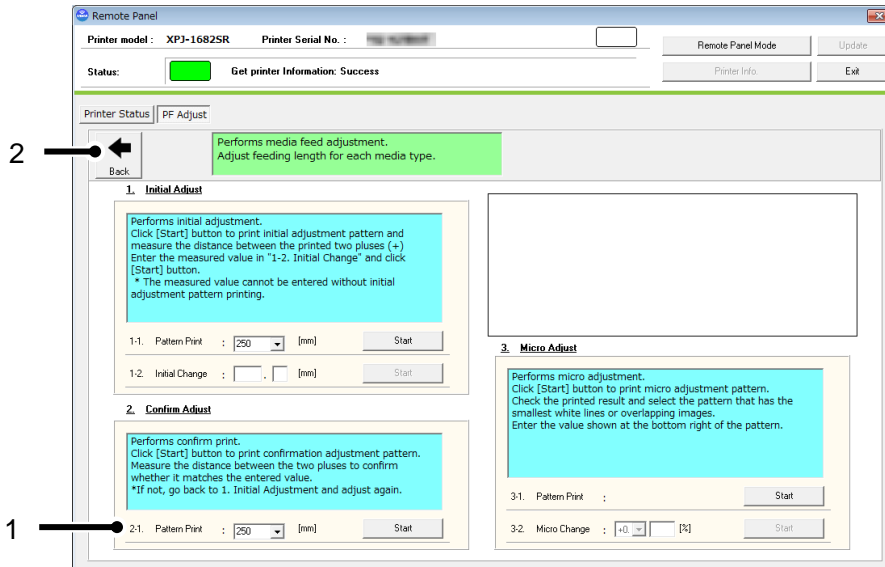

No.	Name	Description
1	Pattern Print - Start	Print the PF adjustment pattern with current setting. Pattern length : 100 [mm] ~ < 250 [mm] > ~ 500 [mm] (in increments of 50 [mm])
2	Back	Go back to the Media Setting Menu.

3) Micro Adjust

Performs micro adjustment.

Click [Start] button to print micro adjustment pattern.

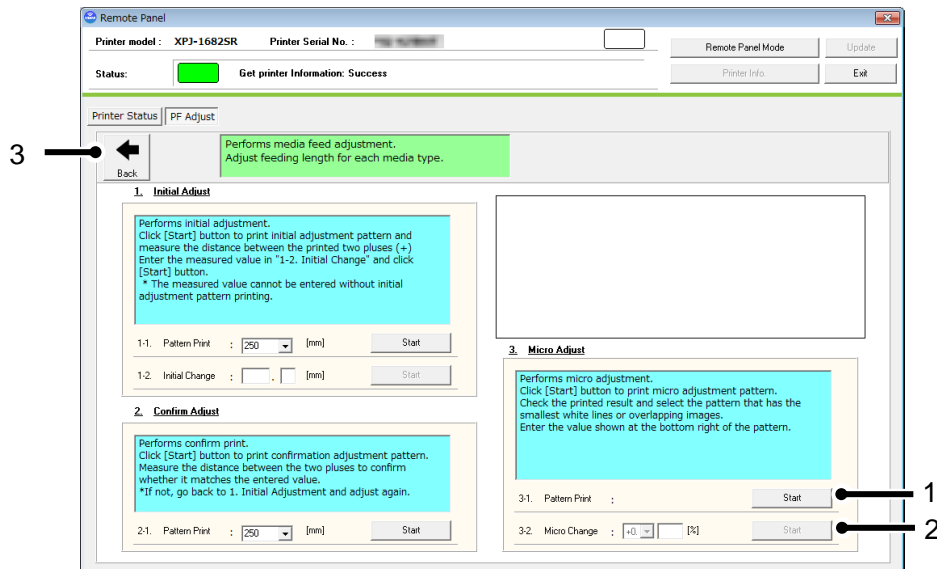

No.	Name	Description
1	Pattern Print - Start	Print the PF adjustment pattern with current setting.
2	Micro Change - Start	Set the micro adjustment value to the printer. Adjustable range: ± 5.00 [%] from the initial PF adjustment pattern (in increments of 0.01[%]).
3	Back	Go back to the Media Setting Menu.

13.4.4.3. Media Type Copy

The selected user type settings can be copied to other user type.

The settings which can be copied are as follows:

Print Mode / Effect / set values for Adjust Print /

PF Adjustment values (initial feeding length/initial adjustment value/micro adjustment value) /

Heater / Vacuum Fan / Media Thickness / Media Setting

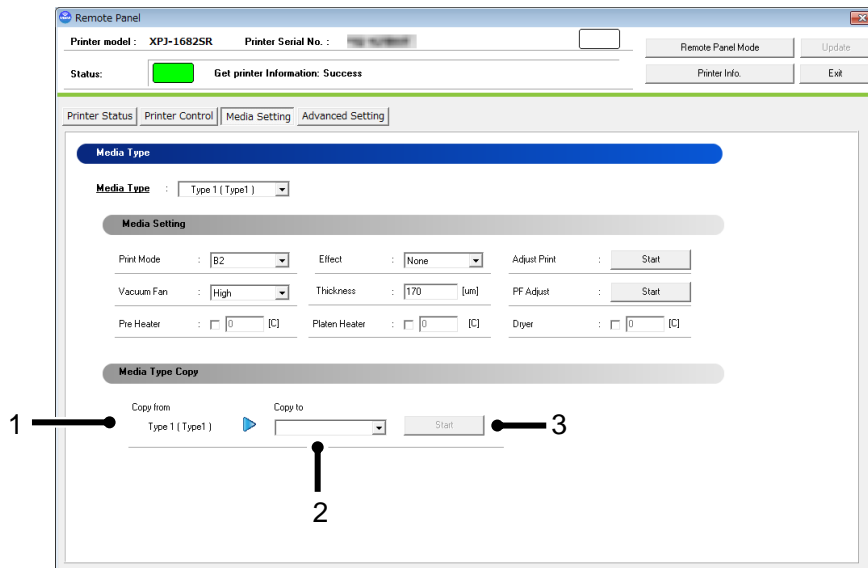

No.	Name	Description
1	Copy from	The selected Media Type is displayed.
2	Copy to	Select a Media Type that you want to copy to. All the Media Types other than the source Media Type can be selected. e.g.: If "User Type 1" is selected, the available copy destination will be User Type 2-15 or ALL.
3	Start	Start copying the setting.

NOTE

- Once the setting of copy destination is changed, it cannot restore to the original setting.

13.4.5 Advanced Setting

Check and change the advanced setting set in the printer.

From this menu, user can check the initial printer settings, and initialize the each setting to factory default.

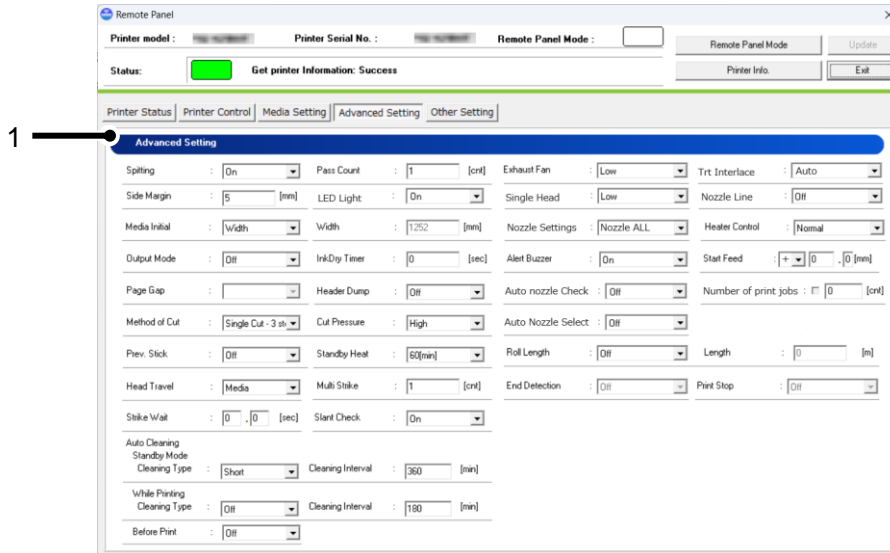

No.	Name	Description
1	Advanced Setting	Check and change the advanced setting set in the printer.

13.4.5.1. Advanced Setting

Check and change the advanced setting set in the printer.

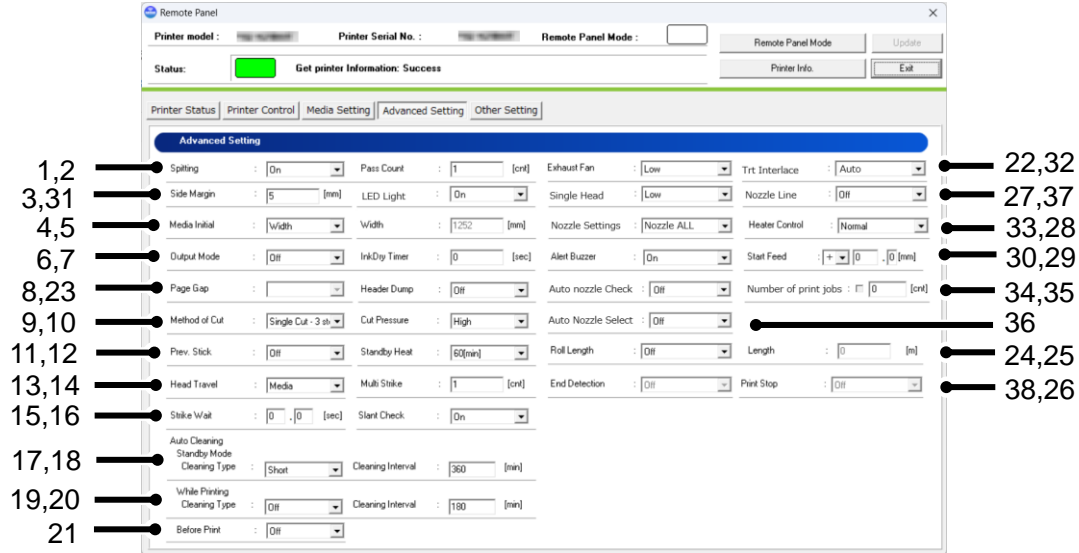

No.	Name	Description
1	Spitting	Set the spitting operation while printing. Setting : < On > / Off
2	Pass Count	Set the frequency (Pass Count) that the print head returns to the spitting box (located) on the origin side when setting "On" or "On Media" in the Spitting menu. Setting : < 1 Cnt > ~ 999 Cnt
3	Side Margin	Check and change the side margin setting of the media. Setting : < 5 mm > ~ 25 mm
4	Media Initial	Check and change the media initial setting of the media. Setting : Off / Top&Width / < Width >
5	Width	Check and change the width of media. When the "Media Initial" is set to "Off", the "Media Width" can be changed. When the "Media Initial" is set to other than "Off", the media initialization will be performed and the media width will be displayed on this menu. XPJ-1682SR/1641SR/1682WR/1642WR/1641SR-P/1682SR-P/PK Setting : 210 mm ~ < 1000 mm > ~ 1625 mm XPJ-1341SR-P/1341WR-P Setting : 210 mm ~ < 1000 mm > ~ 1371 mm
6	Output Mode *1	Set the media operation after printing. Setting : < Off > / Take-up *1 / Auto Cut
7	InkDry Timer	Set the ink drying time. Setting : < 0 sec > ~ 3600 sec (60 min)

No.	Name	Description
8	Page Gap *2	Set the margin between images. Setting : < Normal > / Narrow
9	Method of Cut *3	Set the media cutting operation after printing. Setting : SingleCut-2 steps / < SingleCut-3 steps > / DoubleCut-2 steps / DoubleCut-3 steps
10	Cut Pressure	Set the media cutting pressure for the cutting operation. Setting : Low / < High >
11	Prev. Stick *4,8,9	Set to prevent media from sticking when printing starts. Setting : < Off > / On
12	Standby Heat *8,9	Set the time to preheat the heater while the printer is n standby mode. Setting : Off ~ 10 min ~ < 60 min >
13	Head Travel	Set the range that the print head moves while printing. Setting : Data / Machine / < Media Width >
14	Multi Strike	Set the overwrite count per line. Setting : < 1 Cnt > ~ 9 Cnt
15	Pass Wait	Set the waiting time while overwrite printing. Setting : < 0.0 sec > ~ 0.1 sec ~ 5.0 sec Use this setting when you want to print on the narrow media or the heater is unable to sufficiently warm up the media.
16	Slant Check	Set the slanting detection during media loading. Setting : Off / < On >
17	Auto Cleaning - Standby Mode Cleaning Type *16	Select the cleaning type to be performed automatically during standby mode. Setting : < Off > / Short / Normal / Long XPJ-1641SR-P/1341SR-P Setting : Off / Short / Normal / Long / < Flushing >
18	Auto Cleaning - Standby Mode Cleaning Interval	Set the time for auto-cleaning in WaitingTime mode. Setting : 10 min ~ < 360min> ~ 1440 min XPJ-1682WR/1341WR-P Setting : < Off > / 10 min ~ 360min ~ 1440 min
19	Auto Cleaning - While Printing Cleaning Type *12	Select the cleaning type to be performed automatically during printing. Setting : < Off > / Short / Normal / Long
20	Auto Cleaning - While Printing Cleaning Interval	Select the time for auto-cleaning while printing. Setting : < 5 min > ~ 180 min XPJ-1682WR/1341SR-P/1341WR-P Setting : < Off > / 5 min ~ 180 min
21	Auto Cleaning - Before Print	Set the value for auto-cleaning in pre-printing mode. Setting : < Off > / Short / Normal / Long XPJ-1341SR-P/1341WR-P Setting : < Off > / On

No.	Name	Description
22	Exhaust Fan *10	Set the exhaust fan. Setting : < Off > / Low / High XPJ-1642WR Setting : Off/ Low / <Medium> / High
23	Header Dump	Set whether to print the following information (dump data) of print data. The dump data will be used as a reference material to receive technical supports.
24	Roll Length	Set the roll media length. Setting : < Off > / Roll1 / Roll2 / Roll3
25	Length *5	Set the roll media length. Setting : 1 m ~ < 30 m > ~ 1500 m XPJ-1341SR-P/1341WR-P Setting : 1 m ~ < 30 m > ~ 200 m
26	Print Stop *6	Specify whether to stop printing when the remaining roll media is 0[m]. Setting : < Off > / On
27	Single Head *7	Set the single head. Setting : < Off > / Head1 / Head2
28	Heater Control *8	Set the heater control. Setting : < Normal > / Fixer / Dryer
29	Start Feed	Set the media feed amount at print start. Setting : -10.0mm ~ < 0 mm > ~ 500.0mm Unit : 0.1mm
30	Alert Buzzer	Check and change the alert buzzer setting. Setting : < On > / Off
31	LED Light *10,17	Check and change the LED light setting. Setting : < Auto > / On / Off
32	Top Edge Treatment	Check and change the Top Edge Treatment in the printer. Setting : Off / < Auto >
33	Nozzle Settings *13 Nozzle Area Select *15	Check and change the Nozzle Settings in the printer. Setting : < Nozzle ALL > / Nozzle A / Nozzle B / Nozzle C / Nozzle D / Nozzle E / Nozzle F
34	Auto Nozzle Check *14	Check and change the Auto Nozzle Check in the printer. Setting : < Off > / On
35	Number of print jobs *11,14	Check and change the Numver of print fobs in the printer. Setting : < Off > / 1 – 30 [Cnt]

No.	Name	Description
36	Auto Nozzle Select *11,14	Check and change the Auto Nozzle Select in the printer. Setting : Off / < On >
37	Nozzle Line *15	Check and change the Nozzle Line in the printer. Setting : < Off > / Odd / Even
38	End Detection*6,18	Check and change the End Detection in the printer. Setting : Off / < On >

NOTE

- If the previous version of F/W is installed, the settings may not be properly reflected. Make sure to install the latest F/W.
- *1 When the take-up unit is not installed, do not set Output mode to "Take-up".
By doing so, the product will be unable to function properly.
- *2 When the Output Mode menu is set to "Take Up", the Page Gap menu will be available.
- *3 When the media detection is set to "Off", the media cannot be cut automatically.
Some media may not be cut (cannot be cut at all or cannot be cut finely).
If the roll media length is not specified, the remaining media length may not be displayed correctly.
- *4 When the Output Mode menu is set to "Take-up", the setting for the Prev. Stick menu is disabled.
- *5 After replacing the roll media, set the roll media length again.
If the roll media length is not set, the residual quantity of roll media may not be displayed correctly.
- *6 The Print Stop menu is available when the Roll Length menu is set to either of Roll1, Roll2 or Roll3.
- *7 This function is available for XPJ-1682SR/1682WR/1642WR
- *8 This function is available for XPJ-1682SR/1641SR *9 This function is available for XPJ-1642WR
- *10 This function is available for non-XPJ-1341SR/1341WR-P.
- *11 Enabled when the Auto Nozzle Check is set to "on".
- *12 This function is available for XPJ-1682SR/1641SR/1642WR/1641SR-P
- *13 This function is available for 1642WR/1341SR-P/1641SR-P/1341WR-P
- *14 This function is available for XPJ-1641SR-P/1642WR
- *15 This function is available for XPJ-1682SR-P/PK
- *16 This function is available for XPJ-1682SR/1641SR/1641SR-P/1642WR/1682SR-P/PK/1341SR-P
HA-1642
- *17 HA-1642 is not supported.
- *18 This function is available for HA-1642

13.4.6 Other Setting

From this menu, user can check the initial printer settings, and initialize the each setting to factory default.

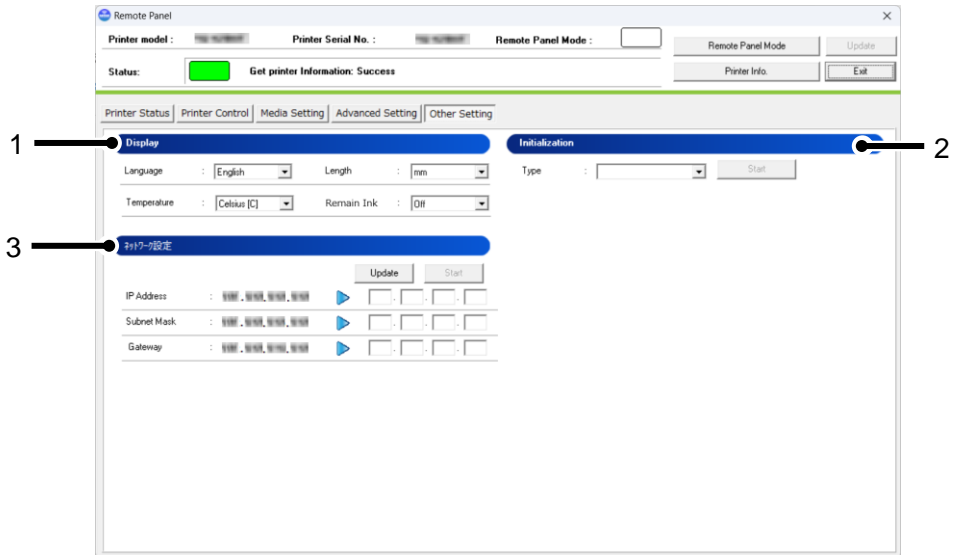

No.	Name	Description
1	Display	Check and change the display setting set in the printer.
2	Initialization	Initialize the each setting to factory default.
3	Network setting	Check and change the network setting set in the printer.

13.4.6.1. Display

Check and change the display set in the printer.

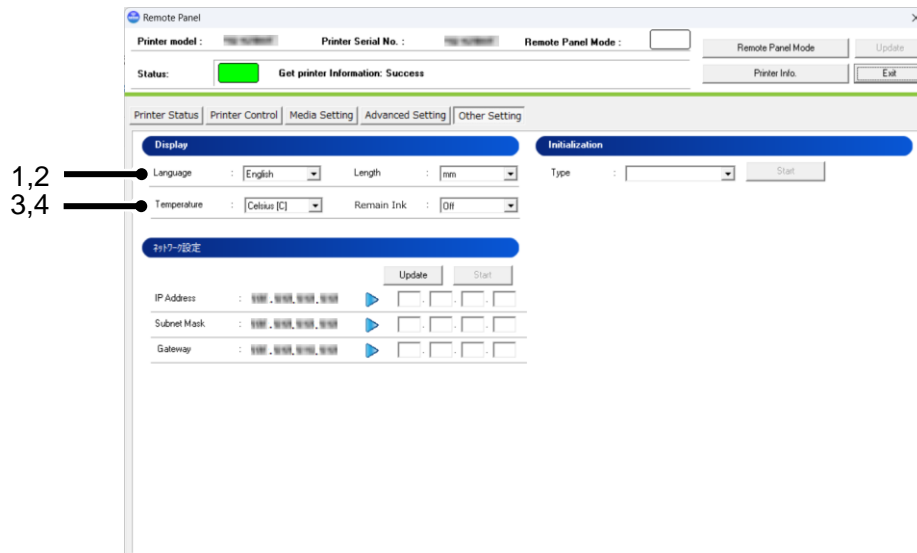

No.	Name	Description
1	Language	Check and change the Language in the printer. Setting : < English > / Dutch / Spanish / French / Italian / Portuguese / German / Japanese XPJ-1341SR-P / 1341WR-P : Setting : < English > / Japanese
2	Temperature	Check and change the Temperature in the printer. Setting : < Celsius [C] > / Fahrenheit [F]
3	Length	Check and change the Length in the printer. Setting : < mm > / inch
4	Remain Ink *1	Set whether to display the remaining ink amount. Setting : Off / <On>

NOTE

- *1 This function is available for XPJ-1341SR-P/1341WR-P

13.4.6.2. Initialization

Returns the settings of the printer to default.

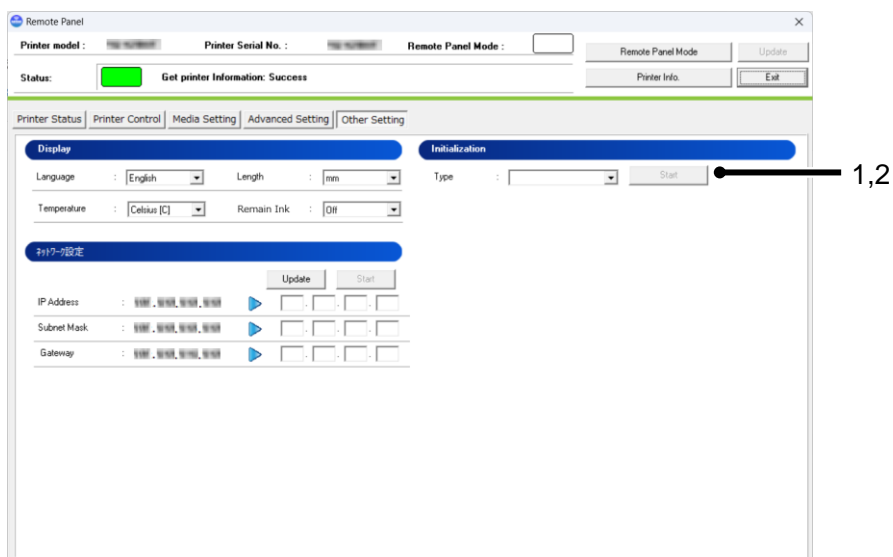

No.	Name	Description
1	Type	<p>ALL :</p> <p>All settings can be returned to factory default.</p> <p>Media Type :</p> <p>The setting of the Media Type is returned to factory default.</p> <p>Except Media Type :</p> <p>All settings except the Media Type are returned to factory default.</p>
2	Start	Initialize the selected setting to the factory default.

NOTE

- The network configuration cannot be initialized.
To change the network configuration, use the MUTOH LFP Finder application.

13.4.6.3. New network setting

Check and change the network setting set in the printer.

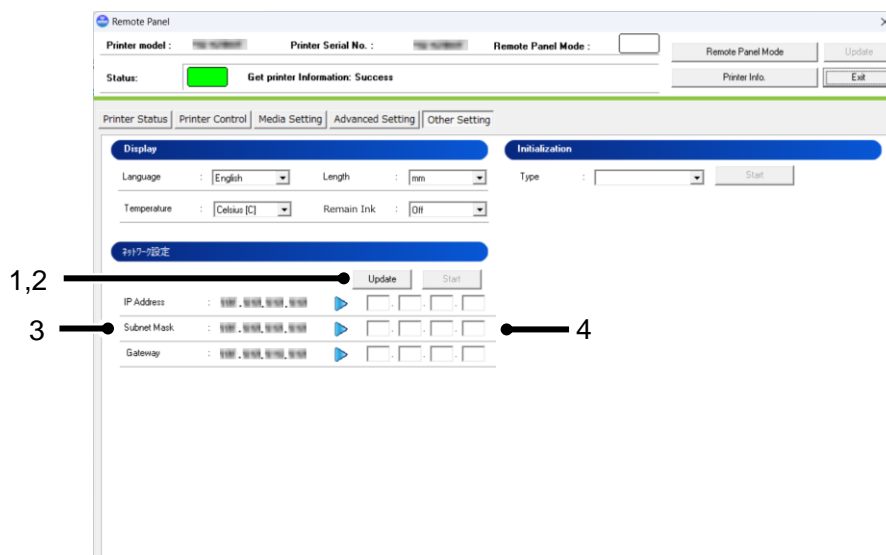

No.	Name	Description
1	Update	Enable input boxes to enter new setting.
2	Start	Change the network configuration setting.
3	Current network configuration setting	Displays the current network configuration setting.
4	New network configuration setting	Enter the new network configuration setting that you want to change.

NOTE

- If you want to change the network configuration setting of the printer which does not support this function, change the setting using the ValueJet Finder application which comes with the printer.
- If you change the network configuration while printing, you cannot complete printing.
- If unable to communicate with the printer after changing the network configuration, restart your printer. If the communication is still not successful, check the network configuration from MUTOH LFP Finder.
- The network configuration cannot be initialized.
To change the network configuration, use the MUTOH LFP Finder application.

14. MUTOH Print Server

As a data pre-processing application, Mutoh Print Server (MPS) enhances the printing performance.

14.1. Notes for Use

14.1.1 Preparation

MPS runs as preprocessing software for MUTOH printers to help printer functions via Ethernet connection.

By specifying PC's IP address from RIP, MPS receives a print data to optimize and send it to printer.

Fig 1 Before Installing MPS

RIP sends a print data directly to printer .

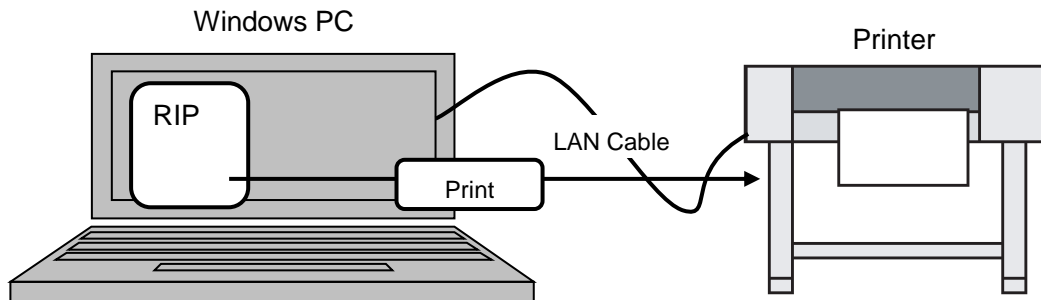
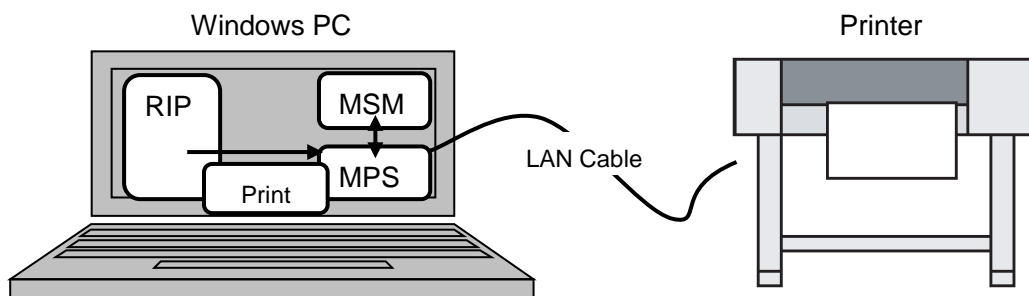

Fig 2 After Installing MPS

RIP sends a print data to MPS. MPS optimizes and sends it to printer.



NOTE

- MSM can run, stop or monitor MPS.

14.1.2 Software RIP Setup

Specify your PC's IP address from RIP.

For the IP address settings, refer to the manual that comes with the RIP software.

NOTE 

- When the protocol such as "FTP" or "LP" is specified in the software RIP setting, the protocol change may be also required. Select "Raw" or "RawIP" for this case.
For the process to specify the protocol to software RIP, refer to the setting process for each software RIP.
- 

14.1.3 Windows Firewall Exception Setting

If you installed Windows Vista or later, MPS needs to be allowed through Windows Firewall.

MPS is automatically added to the Windows Firewall exception list while installing MSM.

If the printing is not available via MPS, check the Windows Firewall exceptions setting.

NOTE

- If using virus security software other than Windows firewall, the exception setting may be required depending on the software. For further details, contact to the software manufacturer.

(1)

Open the Control Panel from Windows Start menu.

「Windows10」

Go to **Start** menu. Scroll down and open **Control Panel** in **Windows System**.

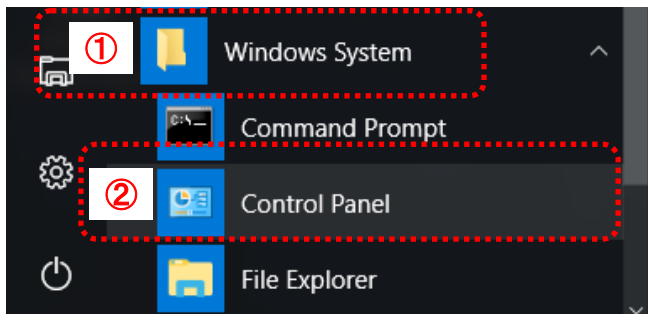

(2)

Execute [System and Security].

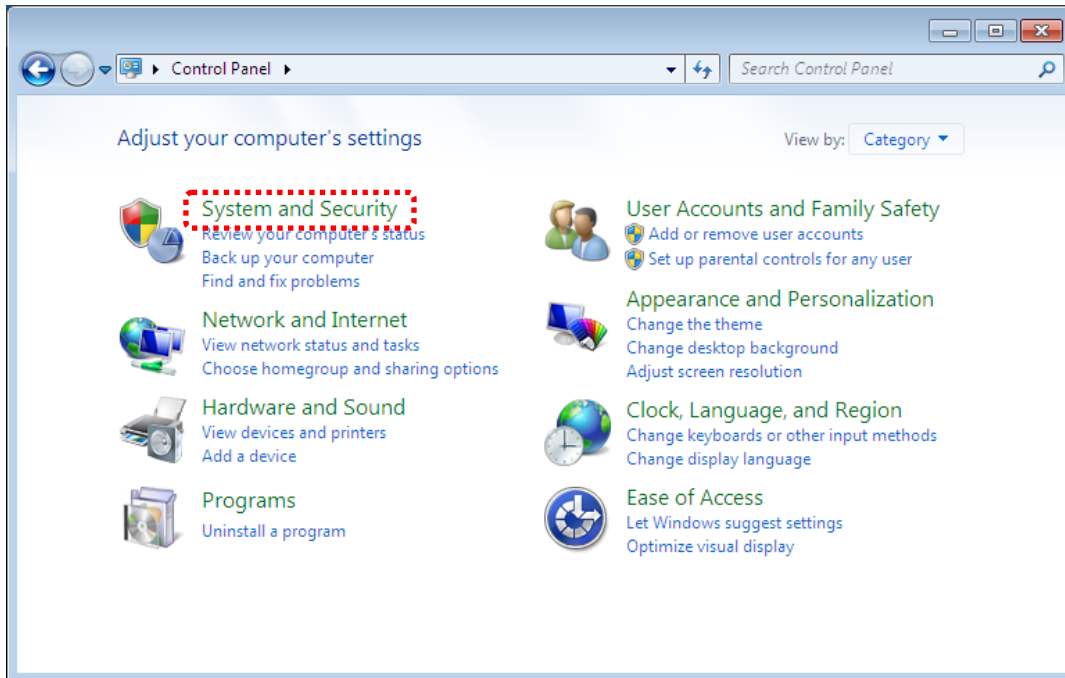

(3)

Click [Allow a program through Windows Firewall].

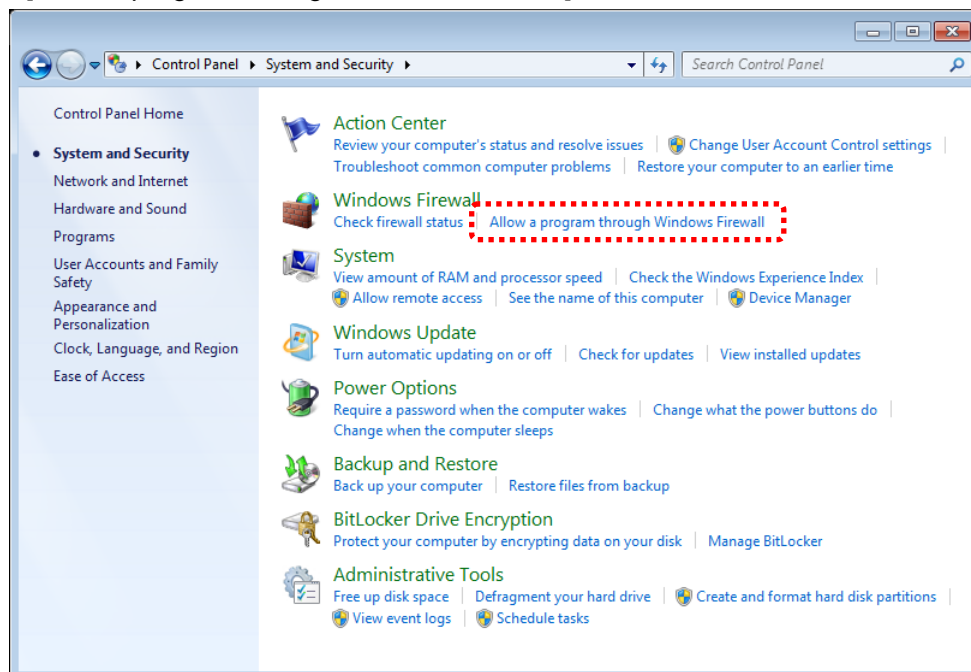

(4)

Click [Change Settings].

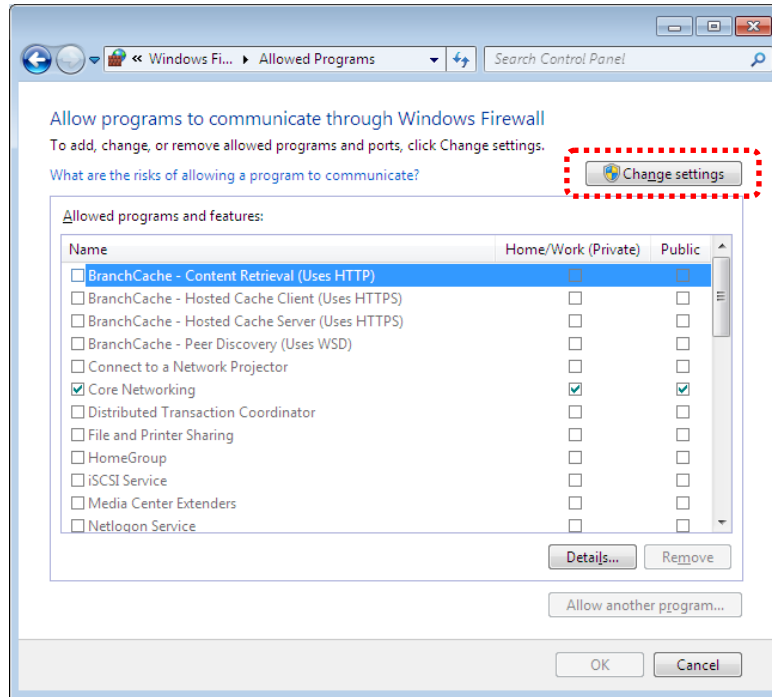

(4)

Click [Allow another program].

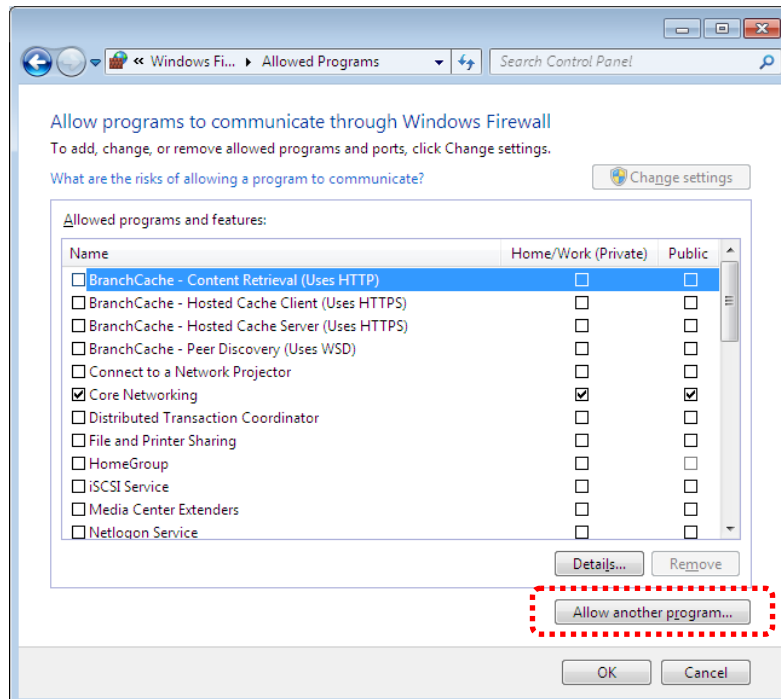

(5)

Click [Browse].

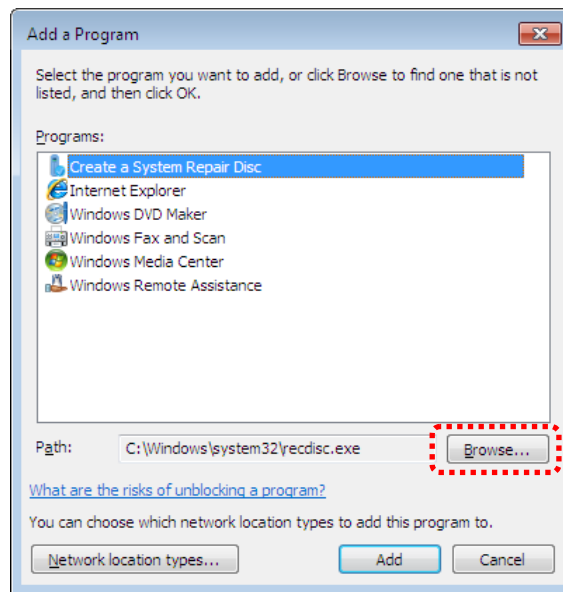

(6)

Select the installed folder.

If the folder with MUTOH Print Server installed has not changed, the installed folder is

[C:\Program Files (x86)\Mutoh\MUTOH Status Monitor\MPS]

Select "VJEXTERNALSVC.exe" *1 and click [Open].

NOTE

- The location of this folder depends on your operating system.

Example) Windows 10 32bit :

[C:\Program Files\Mutoh\MUTOH Status Monitor]

Example) Windows 10 64bit :

[C:\Program Files (x86)\Mutoh\MUTOH Status Monitor]

*1 When using XPJ-1642WR, select VJEXTERNALSVC-2ndGen.exe.

When using XPJ-1682SR-P, select VJEXTERNALSVC-3rdGen.exe.

(7)

With selecting "VJEXTERNALSVC.exe", click [Add].

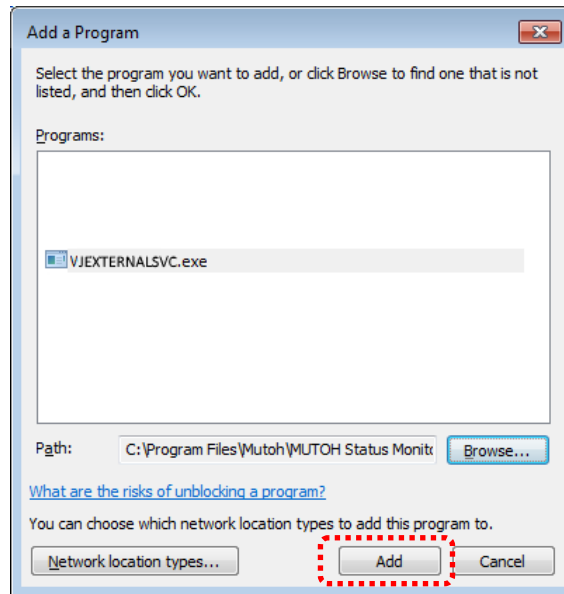

(8)

Click [OK].

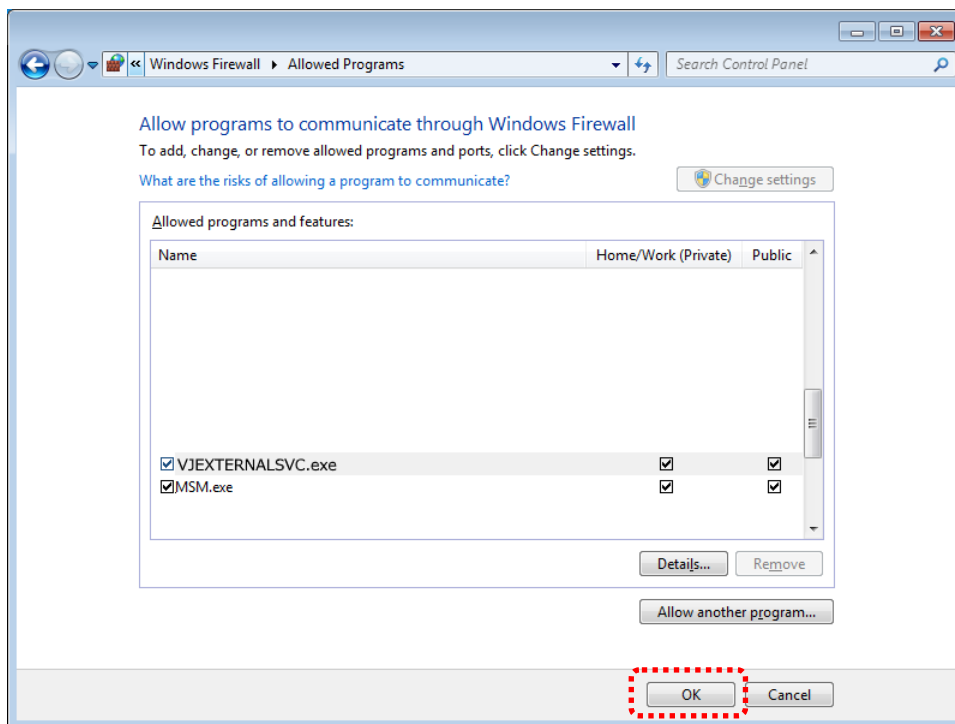

14.1.4 Notes

- To install or run MPS, enable the Windows administrator account.
- Check that the printing is performed via Gigabit Ethernet connection from Windows Task Manager (excluding VJ-1638/VJ-1638W).

14.2. Hardware Requirements

14.2.1 Recommended Hardware Requirements

The recommended hardware requirements to operate MPS are shown in the table below.

Item	Contents
OS (*1)	Windows10 32bit(*2) / 64bit Windows 8/8.1 32bit(*2) / 64bit Windows 7 32bit(*2) / 64bit Service Pack 1
CPU	Intel® Core™ i5 / i7 3GHz or larger
Memory	4GByte or larger (*2)
HDD	SSD (Solid State Drive)
HDD (Free Space)	Network port to compliant with Gigabit Ethernet (requires the printer with Gigabit Ethernet connectivity)
LAN	Windows10 32bit(*2) / 64bit Windows 8/8.1 32bit(*2) / 64bit Windows 7 32bit(*2) / 64bit Service Pack 1

*1 When the above OS support ends, the operation on MPS cannot be ensured.

*2 Please use a 64-bit OS and more than 8 GB of memory if multiple printers or 4head Printer are connected to your PC.

NOTE

You can register the printer up to 5 units. The number of printer that can perform printing at the same time depends on your PC and software.

The read/write speed will slow down when you run RIP on HDD (Hard Disk Drive) and send a print job from RIP to more than one printer via MPS.

It is recommended to run RIP on SSD (Solid State Drive).

If you uninstall MSM when MPS is still enabled, the error appears in Windows event viewer.

The error will not be displayed by installing the next version of MSM.

If you no longer use MPS, please disable MPS on MSM.

NOTE

For recommended operating environment, see the product specification of applicable MUTOH printer.

When PC does not meet the recommended hardware requirements, or depending on the resident software, you cannot achieve the full potential performance of MPS. In this case, try the following solutions:

- **When using network HUB between the PC and printer:**
Connect the PC and printer directly without network.
 - **When using on-the-fly print from RIP:**
Change to RIP then Print.
 - **When using print data from USB hard disk or network drives:**
Copy print data to the hard disk built in PC before printing.

 - **When the printing is temporarily stopped while resident software runs or Windows Update is downloading:**
Stop the program running in the background or change the settings to prevent its running during printing.
-

14.2.2 Example of Network Configuration to use MPS

The application can be used in any one of the recommended environments below.

NOTE

The LAN cable to be connected to the printer should be more than category 5 (CAT5).
If the Printer has Gigabit Ethernet, the network cable should be more than category 5e (CAT5e).

14.2.2.1. Example 1) Peer-to-peer connection

Connect the printer and MPS directly with LAN cable.

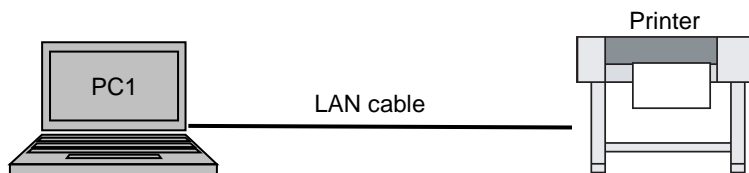

Device	Requirement
PC1	PC with MPS and RIP

14.2.2.2. Example 2) HUB Connection

Connect the printer and MPS via HUB.

You can connect with several printers and start MPS for each printer.

NOTE

If the printer has a Gigabit Ethernet port, use a Gigabit Ethernet HUB.

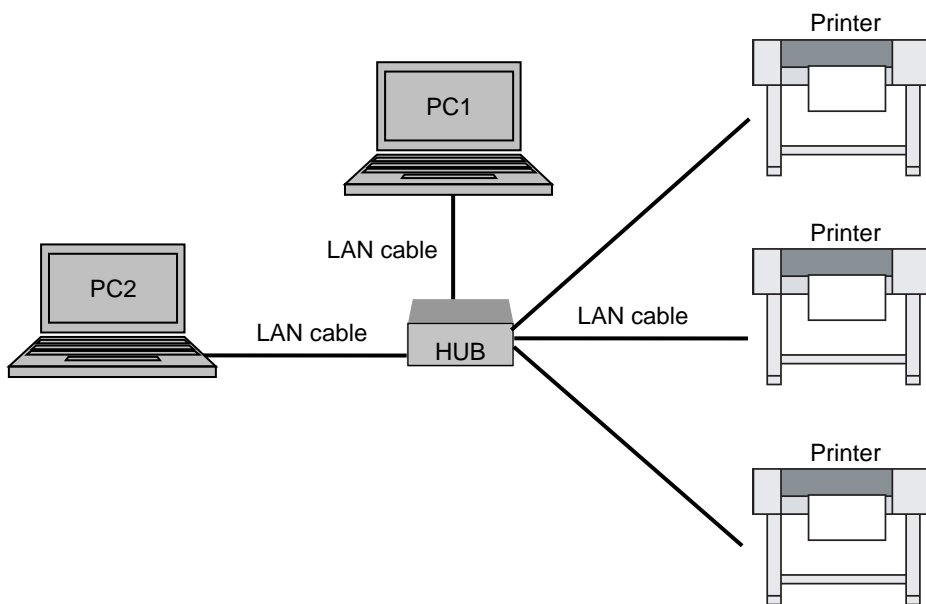

Device	Requirement
PC1	PC with MPS
PC2	PC with RIP for non-Windows platforms

14.3. How to Use MPS

Please follow the procedure below to start MPS. After the setting is completed, the MPS main screen will appear and display the operation status.

14.3.1 Enable MPS

Click [Enable MPS] checkbox when registering a printer.

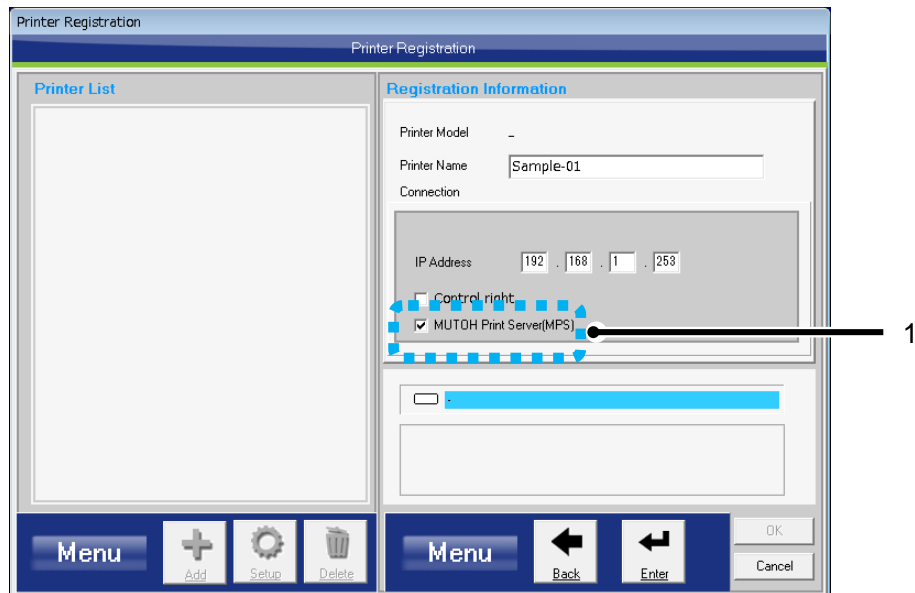

14.3.2 Start MPS

Click [Start MPS] from MSM main menu.

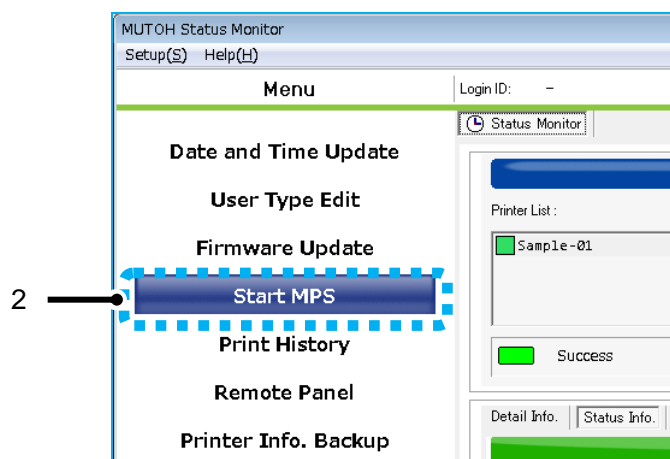

If MPS is disabled, the following message will appear. Click [Yes].

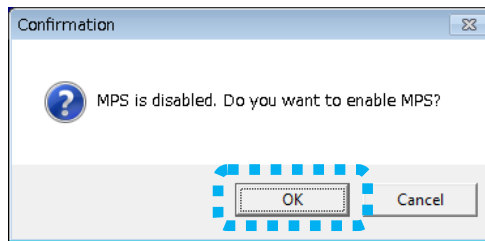

14.3.3 MPS Settings Confirmation Dialog

Click [OK] in the MPS Settings Confirmation dialog.

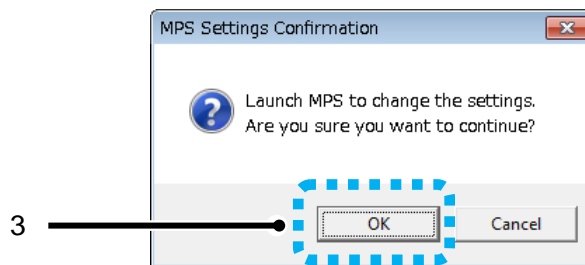

14.3.4 Select MPS Service Number

After the MPS settings confirmation, a window to select the MPS service number will be displayed.

The ValuJet printer information will be registered for each MPS service number.

Select the service number from 001 to 005, and click [Apply].

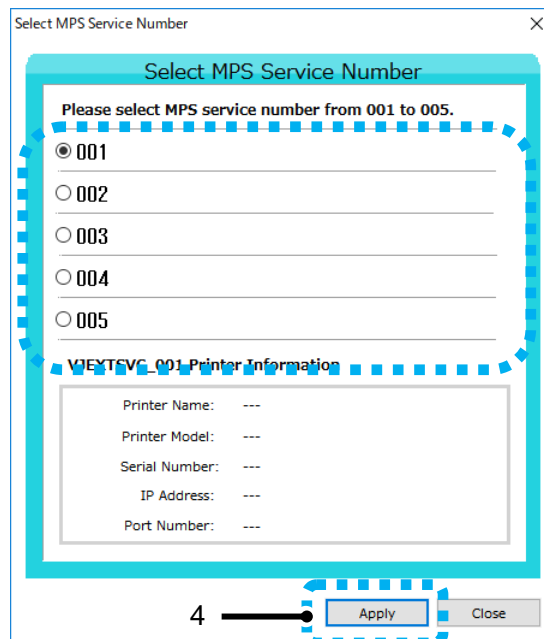

14.3.5 MPSSettings

After selecting the MPS service number, a window to configure each setting for MPS will be displayed. The specific "Port number" is required for each service number.

Click [Save] after setting is completed.

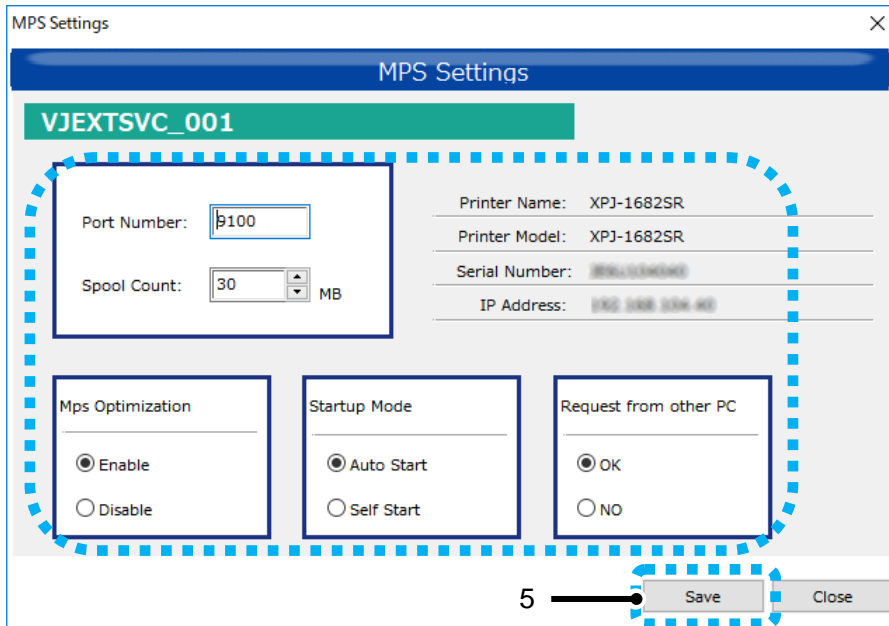

14.3.6 MPS Main Screen

After setting is completed, the MPS main screen will appear and display the start-up status.

You can open each setting screen from the main screen.

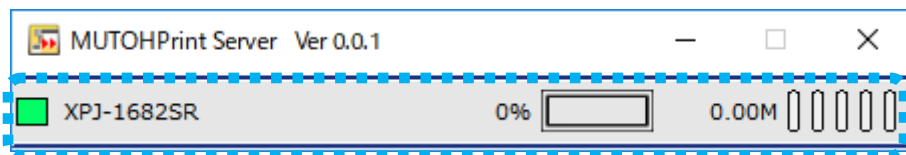

14.4. How to Configure MPS Settings

This chapter explains each setting for MPS.

14.4.1 MPS Service Number

Select the MPS service number to register the ValuJet printer information.

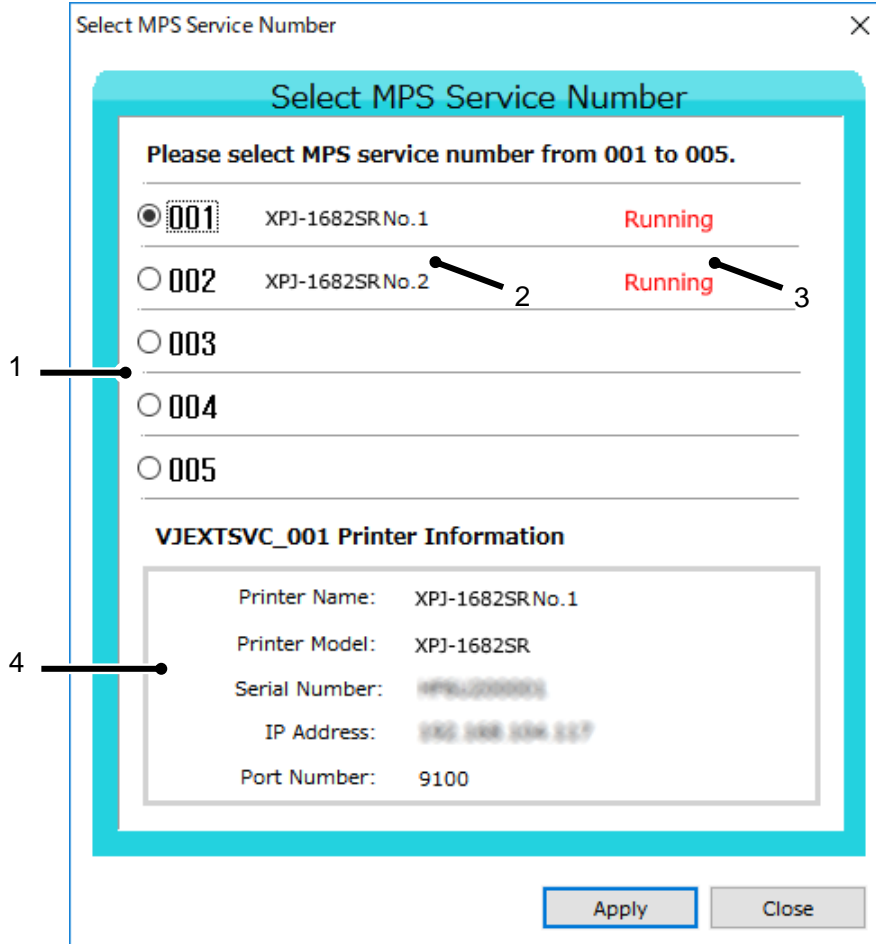

No.	Name	Description
1	MPS Service Number	Select the MPS service number to be registered in Windows service (resident program).
2	Printer Name	Displays the printer name set in the service number being used.
3	Running Status	Displays the running status of each service number being used.
4	Printer Information	Displays the printer information set in the service number being used.

(1)Notes for selecting the service number

You cannot select the service number being used. Please select the number that the printer name is not displayed. If selecting the number being used, the following warning message will be displayed.

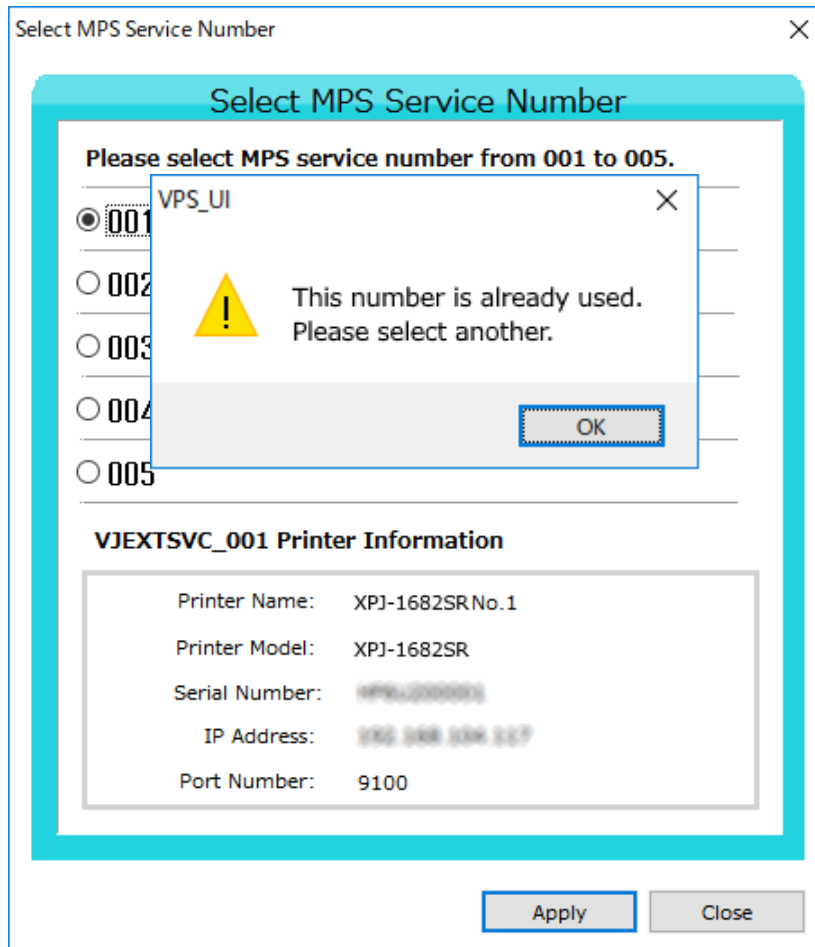

14.4.2 MPS Setting

Configure the initial settings for each MPS service number.

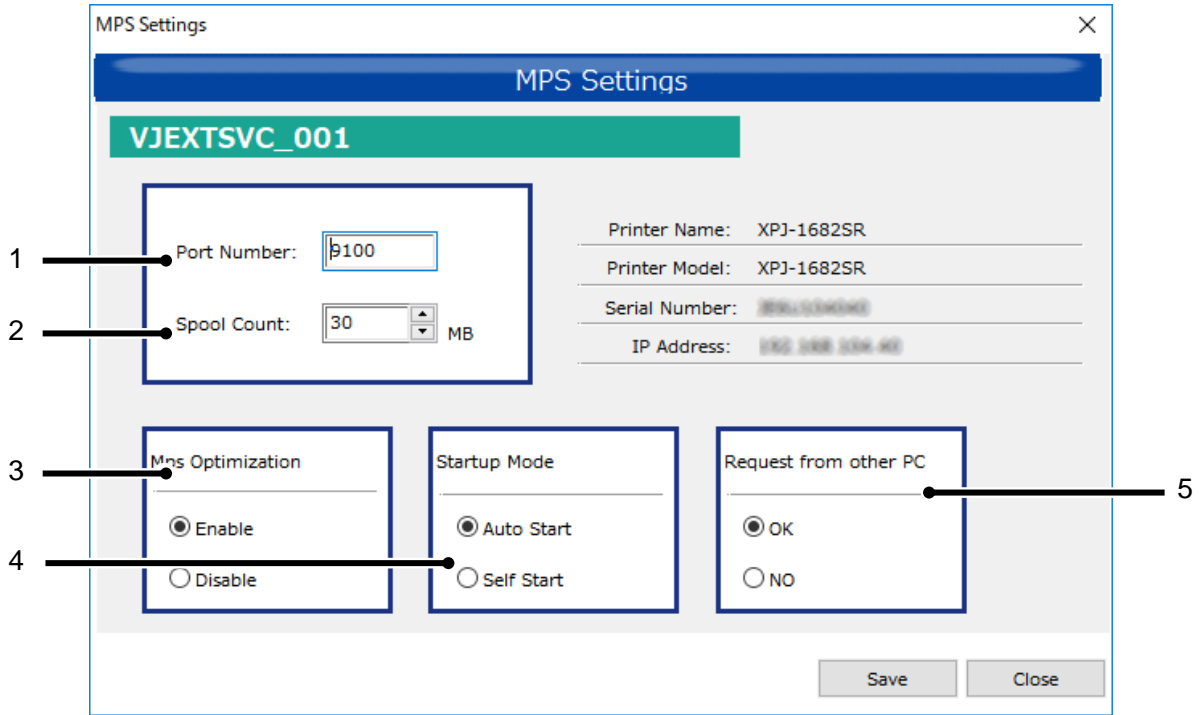

No.	Name	Description
1	Port Number	When port 9100 is used by another program, change the port number for MPS. Change a RIP port number accordingly. See the RIP manual for the procedures.
2	Spool count	Set the spool size for MPS. The default value is set to an optimal value for each printer.
3	MPS Optimization	If the check box is checked, perform the data processing via MPS. If a data cannot be printed via MPS, uncheck the check box.
4	Starting Service	Set the auto-start service.
5	Access from other PC	Permit the RIP connection from other PC. If the check box is unchecked, printing from other PC will not be available.

14.4.3 Main Screen

The main screen will appear after MPS start. You can open the "MPS information" window from this screen.

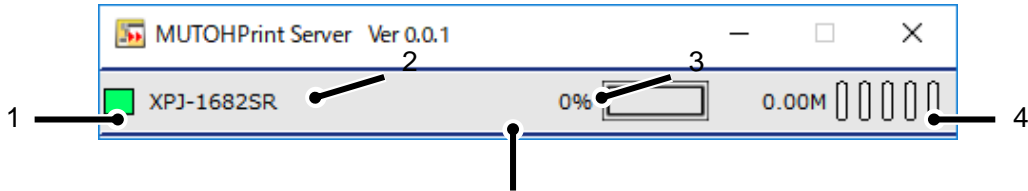

No.	Name	Description
1	Operation Status	Displays the MPS status.
2	Printer Name	Displays the name of printer using MPS.
3	Job Processing Status	Displays the job processing status of MPS.
4	Spool Count	Displays the spool usage if MPS is in process.
5	MPS Information	Click and display the MPS information window.

(1) How to display the MPS information

If you mouse over the printer name on the main screen, the background color will change.

Click on the printer name to display the MPS information.

<p>The screenshot shows two printer entries: 'XPJ-1682SR No.1' and 'XPJ-1682SR No.2'. Both have a green square on the left and '0%' and '0.00M' to the right. A dashed blue box highlights both entries.</p>	<p>Mouse over the printer name you want to check.</p>
<p>The screenshot shows the same two printer entries. The first entry, 'XPJ-1682SR No.1', is now highlighted in dark blue. A mouse cursor is positioned over the printer name.</p>	<p>Click to display the MPS information when the color changes.</p>

14.4.4 MPS Information

You can check each setting for MPS and start/stop the MPS operation on this screen.

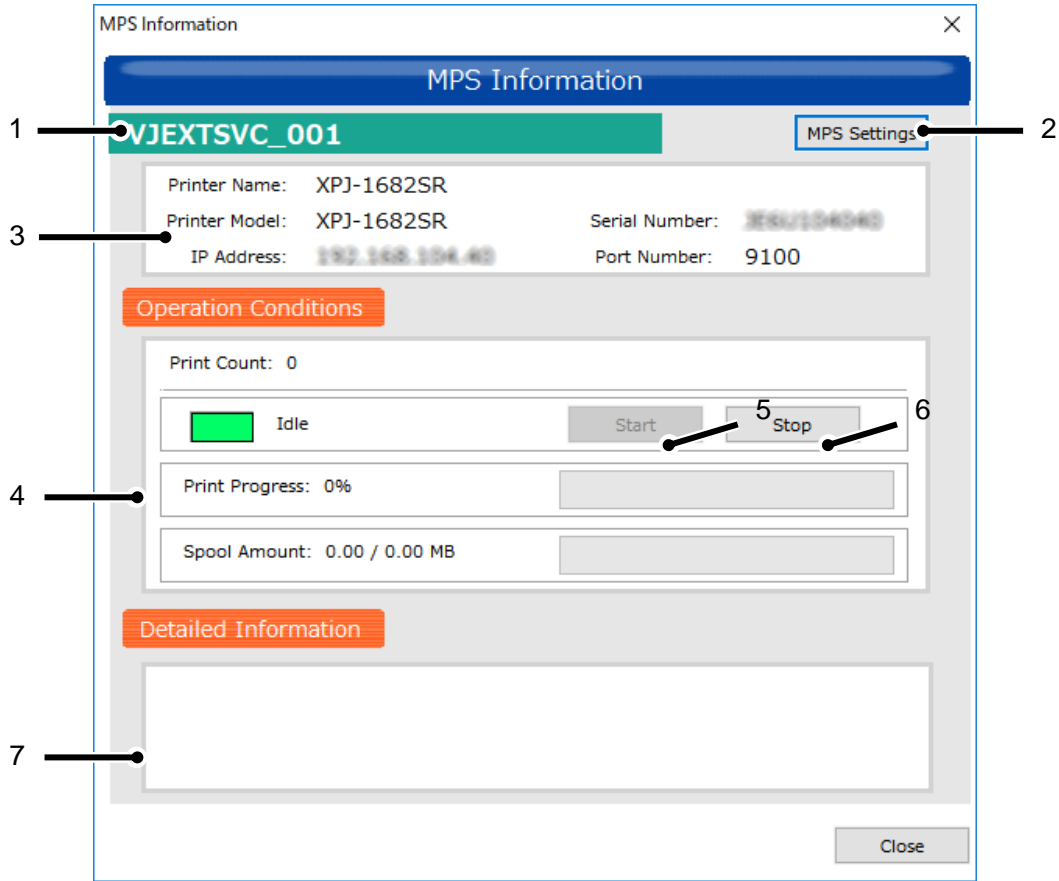

No.	Name	Description
1	MPS Registration Service Name	Displays the MPS service name registered in Windows service (resident program).
2	MPS Setting	Displays 14.4.2 "MPS Setting" window.
3	Printer Information	Displays the printer information set in the MPS service number.
4	Operation Status	Displays the operation status if MPS is in process.
5	Start	Start the MPS operation.
6	Stop	Stop the MPS operation.
7	Detail Information	Displays the detailed information (e.g. error status).

14.4.5 Restart MPS

If an error occurs or after changing the settings, you need to restart MPS.

To restart, click [Stop] button, and then click [Start] button.

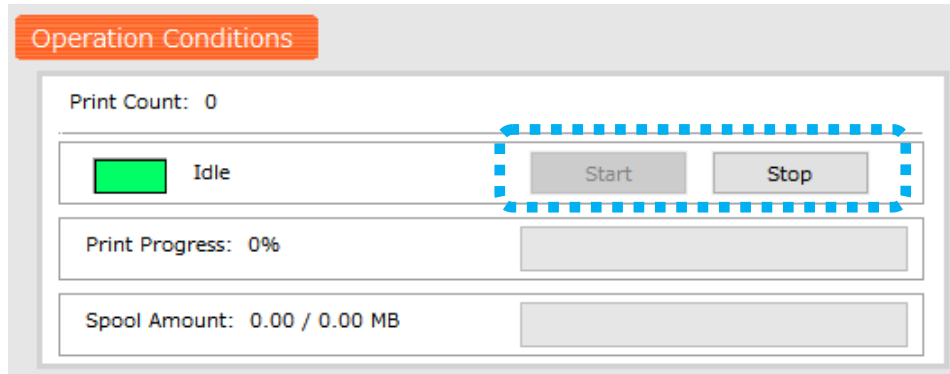

(1) If an error occurs while using MPS

Restart MPS if an error occurs while MPS is in operation.

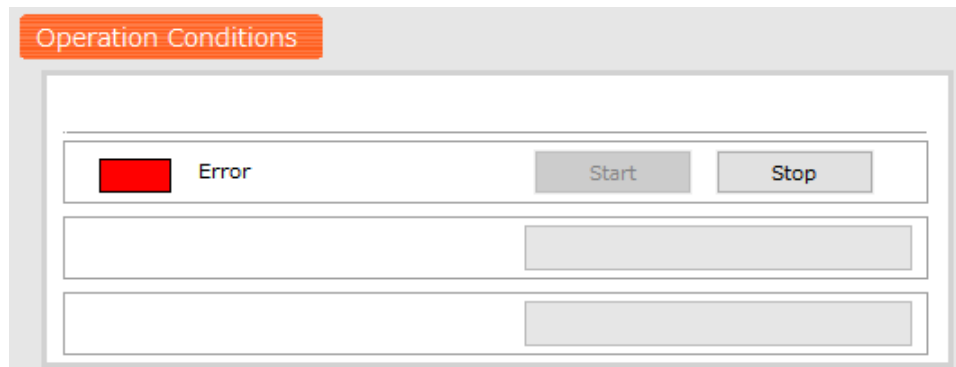

(2) After changing the MPS settings

The MPS settings can be changed on the MPS Settings screen even after the setting is completed.

Restart MPS after changing the settings.

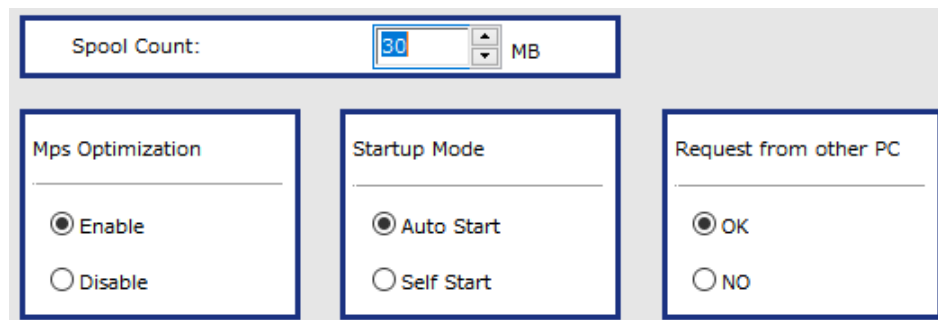

14.5. Restrictions

This chapter describes the restrictions to use MPS and the differences from the direct printing.

14.5.1 When RIP and Spectrophotometer (SPECTROVUE) are used in combination

If you want to use Spectrophotometer (SPECTROVUE) with RIP, directly specify your printer's IP address from RIP. After performing the color measurement, specify the PC's IP address to print via MPS.

See the RIP manual for the IP address settings.

To operate the spectrophotometer via MSM, the IP address change is not required.

14.6. Troubleshooting

This chapter describes common errors and solutions for MPS.

The troubleshooting below is based on that the printer warming-up has been completed.

14.6.1 Troubles for Installation

(1) Printing cannot be performed even after the setup is completed.

1: If you use the following printers, the F/W should be updated as below:

VJ-2638, VJ-1638, VJ-1638W F/W Ver. 2.06 or later

2: Panel messages and solutions:

Case 1: Panel displays **Ready to Print** or **Print Ready**.

Solution: Check the IP address setting.

- MPS > Connection Settings tab

Specify the printer's IP address.

 14.4.4 MPS Information

- Software RIP

Specify your PC's IP address with MSM.

See the RIP manual for the IP address setting.

(If you specify the IP address according to the RIP manual, the PC's IP address for RIP might be specified instead of the PC's IP address for MSM.)

Case 2: Panel displays **Ready to Print** or **Print Ready**.

Solution: If the IP address setting is correct, check if MPS operates properly.

 14.4.4 MPS Information

Case 3: Panel displays **Receiving**.

Solution: Check the Windows Firewall exceptions setting.

 14.1.3 Windows Firewall Exception Setting

NOTE

- The error in Case 3 might occur depending on the network restrictions or resident software.
Check the operating manual of the installed software.
- The error in Case 3 might occur due to the protocol setting of software RIP.

 14.1.2 Software RIP Setup

(2) How to check which **Direct Print** or **Print via VPS** is performed:

1: Check from MSM.

☞ 14.4.4 MPS Information

2: Check the printer status soon after the printing is performed.

If **Print via VPS** is selected, the printer displays **Receiving** and then performs initializations.

If **Direct Print** is selected, the printer displays **Printing** and performs initializations.

3: Check the netstat command from the command prompt.

Example)

Machine	Name	IP Address	Note
PC	PC123	192.168.1.100	PC with MSM and RIP
ValueJet	-	192.168.1.253	VJ-2638

(The numerical value is different every time.)

“MPS”

```
C:\>netstat

Active Connections

Proto Local Address          Foreign Address        State
TCP   PC123:1077             192.168.1.100:9100    ESTABLISHED
TCP   PC123:9100             192.168.1.100:1077   ESTABLISHED
TCP   PC123:1078            192.168.1.253:9200    ESTABLISHED
```

“Direct Print”

```
C:\>netstat

Active Connections

Proto Local Address          Foreign Address        State
TCP   PC123:1076            192.168.1.253         ESTABLISHED
```

14.6.2 Troubles related to Printing

(1) Print result differs between 'via MPS' and 'without MPS'.

1: Check the restrictions may cause this issue.

 **14.5 Restrictions**

(2) Printing cannot be performed suddenly.

1: Restart MPS.

 **14.4.4 MPS Information**

2: If the panel does not display **Ready to Print** or **Print Ready**, restart the printer.

See *Troubleshooting* in the printer's operation manual.

3: If the problem still persists after step.1 and 2, restart PC with MPS and RIP.

15. MiniMSM

The MSM window can be downsized by enabling MiniMSM. With this feature, some functions are limited.

15.1. How to start

Select "MiniMSM" from the MSM setting menu.

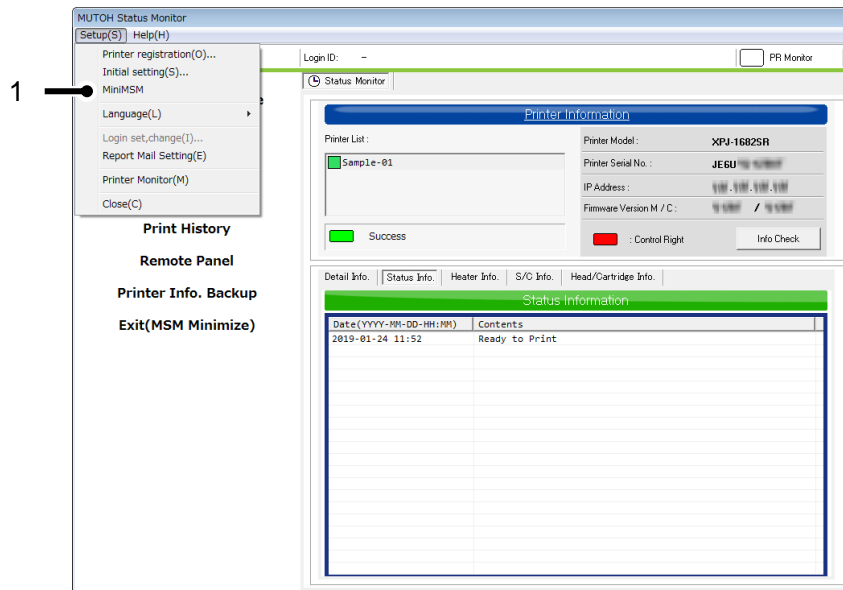

No.	Name	Description
1	MiniMSM	Open the MiniMSM window.

15.2. Main Screen(For models other than XPJ-1462UF)





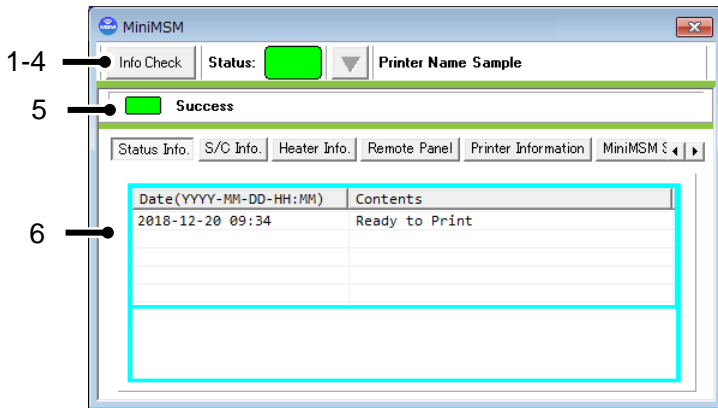

On the MiniMSM main screen, you can check the printer information and remotely control the printer.

Also, the window is resizable.

Maximum size

Minimum size



No.	Name	Description
1	Information Check	Acquire the printer information.
2	Status	Displays the printer status.  : Ready to print  : Error (Not ready to print)  : Warning (Ready to print)
3	Printer Select ▼	Select the printer to obtain the information if multiple printers are registered.
4	Printer Name	Displays the printer name currently selected.
5	Communication Status	Displays the communication status between the printer and PC.  : Communication Success  : Communication Error  : Communicating
6	Printer information	Displays the printer information.

15.2.1 Status Information

Displays the printer status.

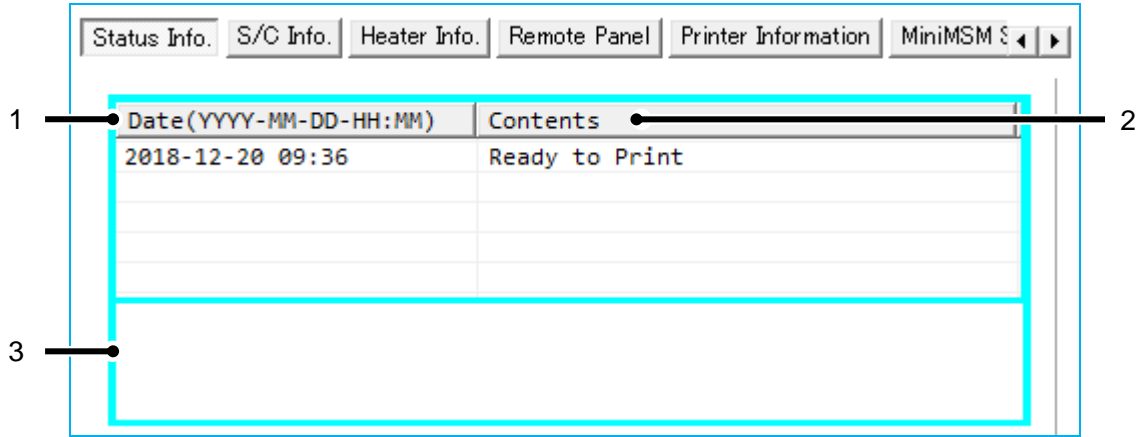

No.	Name	Description
1	Date	Displays the date and time acquired the printer information. The date and time set on the printer will be displayed.
2	Contents	Displays the printer status.
3	Detail Information	Displays the solution if an error occurs.

15.2.2 S/C Information

Displays the S/C remaining ink information in %.

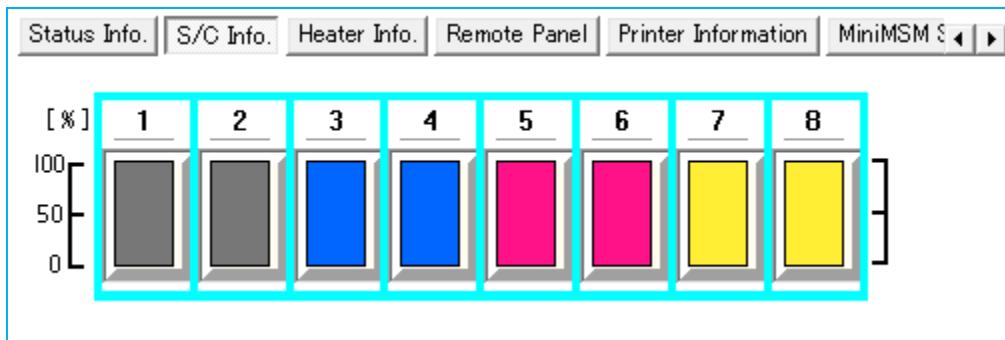

NOTE

- For the details of S/C card recovery, see 7.7.2 S/C Card Recovery.

15.2.3 Smart/C Information

Displays the Smart/C information.

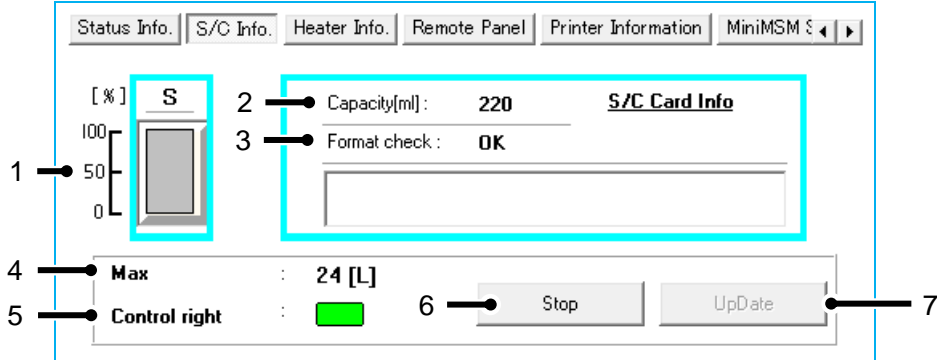

No.	Name	Description
1	Format check	Displays the status of the read S/C card.
2	Capacity [ml] / [L]	Displays the capacity of the read S/C card in ml or L.
3	Detail Information	Displays the reason for the S/C card reading error.
4	Start-Stop	Check and cancel the reading of S/C card.
5	Max	Displays the maximum Smart/C of the printer that has been monitored. * The Smart/C MAX varies according to printer model.
6	Smart/C Amount	Displays in % the remaining amount of Smart/C for the printer that has been monitored.
7	Update	Click the "Update" button to update the Smart/C. Refer to "7.4.4.1 Smart/C Update" for details.

15.2.4 Heater Information

Displays the heater information.

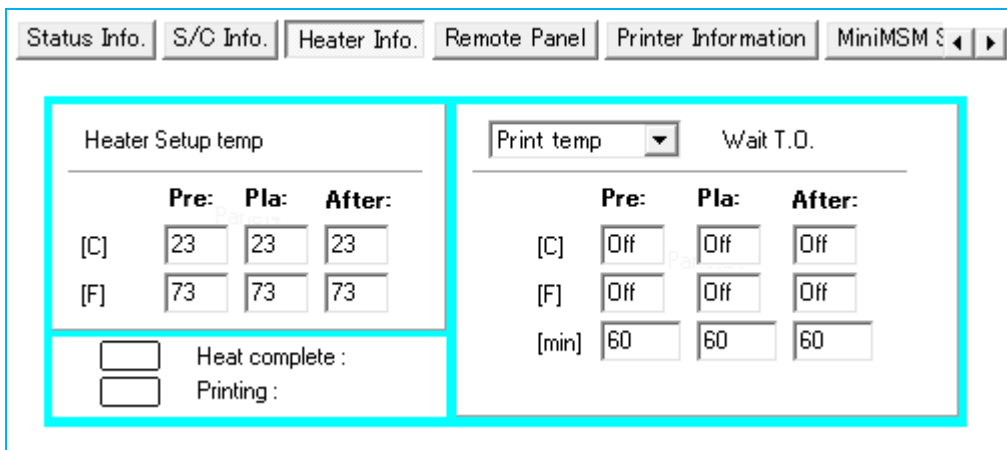

15.2.5 Remote Panel

Remotely control the printer.

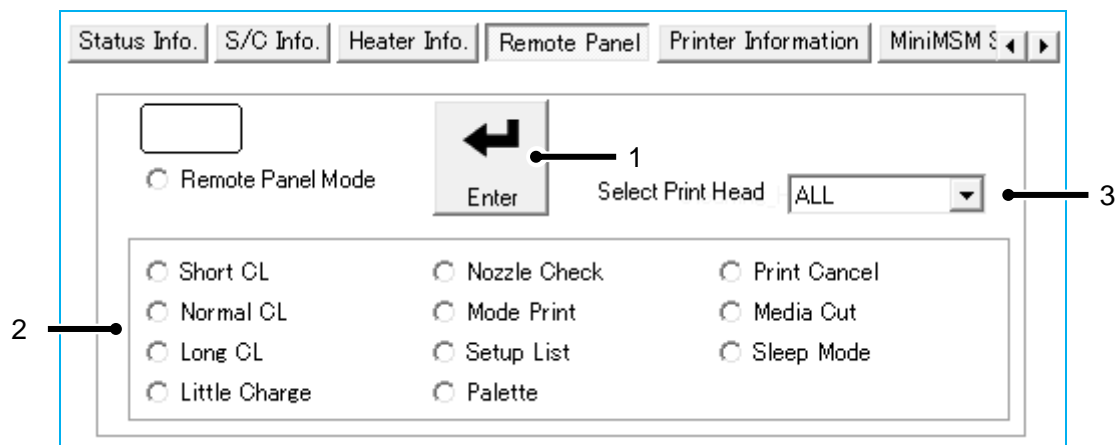

No.	Name	Description
1	Enter	Remotely perform the selected operation.
2	List	Select the operation to be performed remotely.
3	Select Print Head	Select the print head to be cleaned if the printer has more than one print head. Setting : <ALL> / Head 1 / Head 2

NOTE

- The operation that you can perform remotely depends on printer model.
- The remote operation may not be available depending on the printer condition.

15.2.6 Printer Information

Displays the basic printer information.

The screenshot shows the 'Printer Information' tab selected. The interface includes a navigation bar at the top with tabs for 'Status Info.', 'S/C Info.', 'Heater Info.', 'Remote Panel', 'Printer Information', and 'MiniMSM Settings'. The main content area, outlined in cyan, contains the following information:

- Printer Model : [blurred]
- Printer Serial No. : [blurred]
- IP Address : [blurred]
- Firmware Version M / C : [blurred] / [blurred]

15.2.7 MiniMSM Settings

Configure the settings for MiniMSM.

The screenshot shows the 'MiniMSM Settings' tab selected. The interface includes a navigation bar at the top with tabs for 'S/C Info.', 'Heater Info.', 'Remote Panel', 'Printer Information', and 'MiniMSM Settings'. The main content area, outlined in cyan, contains the following settings:

- 1 Auto Printer Information
- Interval : 60 [sec] 2
- 3 Selected Printer

No.	Name	Description
1	Auto Printer Information	Check this box to automatically get printer information. On : Enable Off : Disable *This function is not available when MSM is launched from the Windows printer driver.
2	Interval	When "Auto Printer Information" is ON, set a time interval to get the latest information from the printer. Value can be set from: <60[sec]> / 30[sec] / 10[sec] / 3[sec]
3	Selected Printer	Check this box to monitor only one printer when multiple printers are registered.

15.3. XPJ-1462UF

In the case of XPJ-1462UF, it is possible to remotely control some processing with MiniMSM.

In addition, the MiniMSM screen is always displayed in front of the PC monitor.

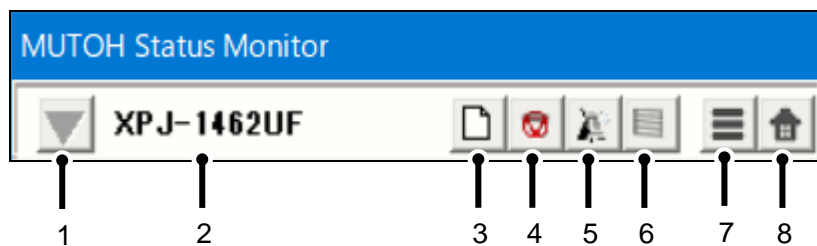

No.	Name	Description
1	Printer Select	Change the printer for which information is obtained when multiple printers are registered.
2	Printer Name	Displays the currently displayed printer name.
3	Media Set	Perform the media set.
4	Print Cancel	Perform the print cancel.
5	Cleaning	Perform the cleaning.
6	Nozzle Check	Perform the nozzle check.
7	Setting	Display the setting screen.
8	Exit	Exit MiniMSM and display the MSM main screen.

15.3.1 Setting screen (Cleaning)

Set the cleaning type and execute cleaning.

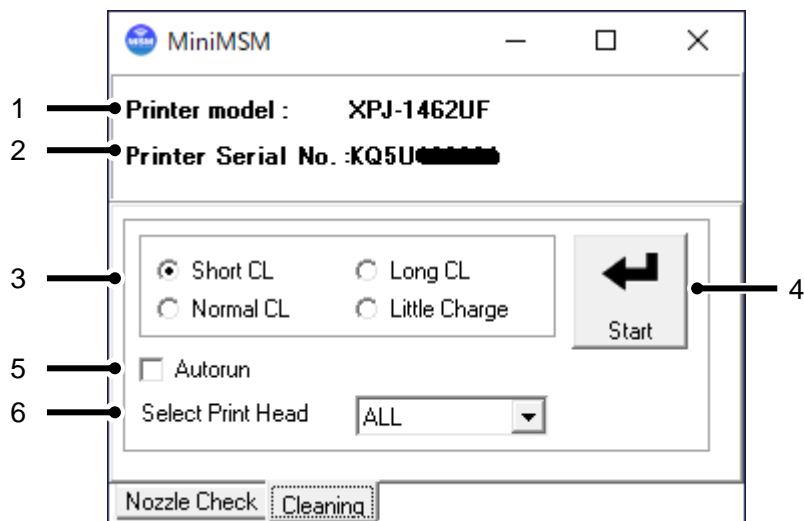

No.	Name	Description
1	Printer Model	Displays the currently displayed printer model.
2	Printer Serial No.	Displays the currently displayed printer serial no.
3	Cleaning Type	Select a cleaning type. Setting : Short / Normal / Long / Little Charge
4	Start	Perform the cleaning.
5	Aurun	When the setting is enabled, when the cleaning type on the MiniMSM screen is selected, cleaning is performed using the set cleaning type without displaying the setting screen.
6	Select Print Head	Select the head to be cleaned.

15.3.2 Setting screen (Nozzle Check)

Set the type of nozzle check and execute the nozzle check.

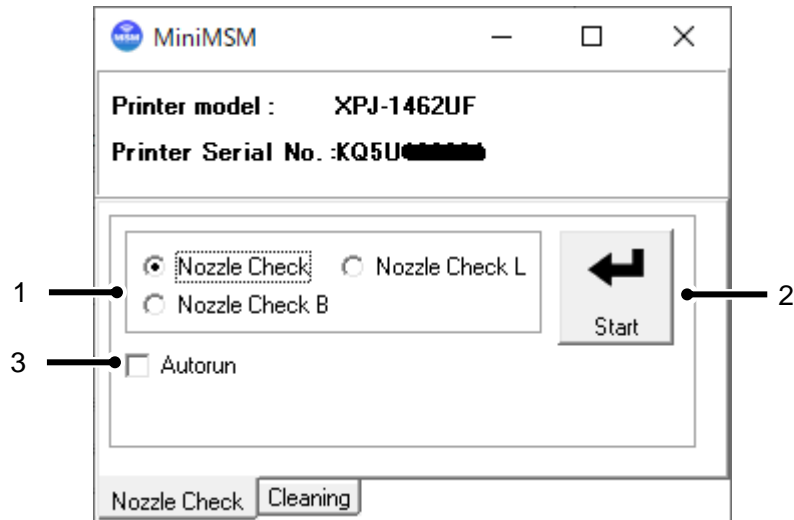

No.	Name	Description
3	Nozzle Check Type	Select a nozzle check type. Setting : Nozzle Check / Nozzle Check B / Nozzle Check L
4	Start	Perform the nozzle check.
5	Aurun	When the setting is enabled, when the nozzle check type on the MiniMUM screen is selected, nozzle check is performed using the set nozzle check type without displaying the setting screen.

16. VerteLith

MSM icon on VerteLith allows user to start MSM installed in the computer.

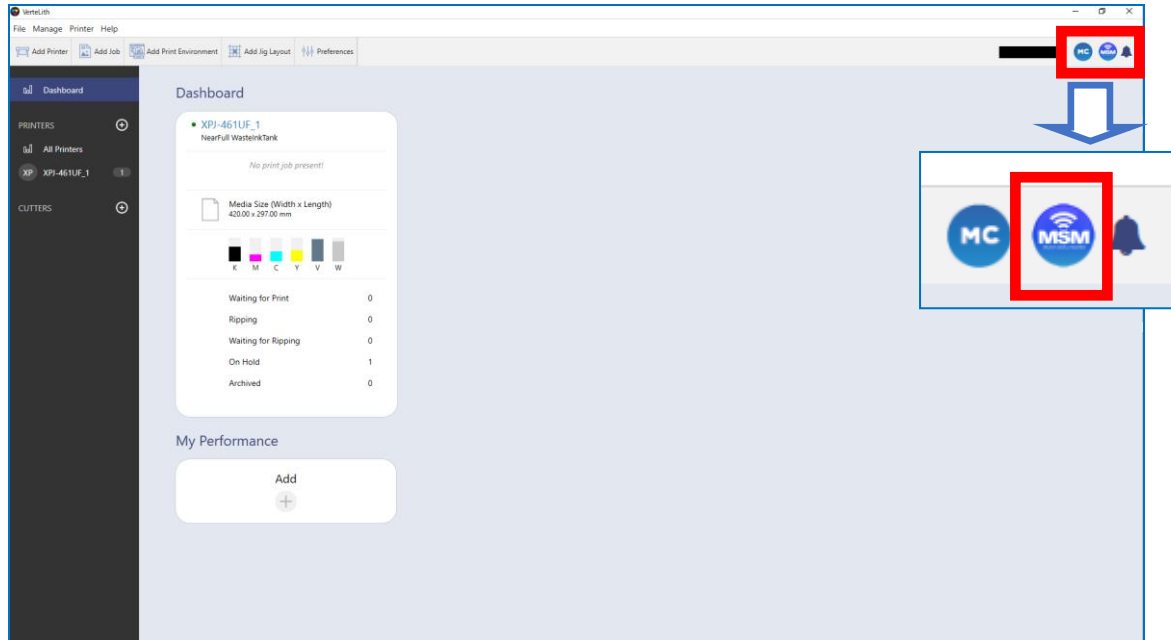

[When MSM is launched from VerteLith]

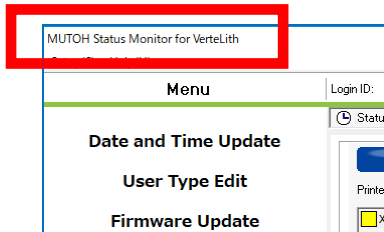

[When MSM is launched independently]

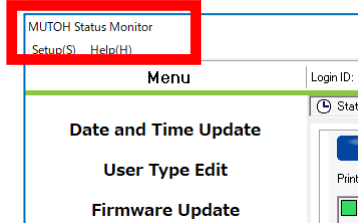

The following restrictions apply when launching MSM from VerteLith.

[Restrictions]

1. MPS:
 - MPS in VerteLith will be launched (not MPS in MSM).
2. MSM configuration:
 - The MSM configuration settings including registered printer will take over from VerteLith. It differs from the settings used when MSM is started independently.

NOTE

- VerteLith will transfer the settings when MSM is launched. If user changes the language on VerteLith after MSM is launched, exit MSM once and restart it from VerteLith.

17. List of Supported Functions for Each Machine Model

The table "Table 16 List of Supported Function for Each Machine Model" below shows the functions that the MSM supports for each printer model.

Table 17.1. List of Functions Supported by MSM for Each Machine Model

O: Supported Δ: Limited Supported -: Not Supported

List of Supported Function	Machine Model			
	VJ-1324 VJ-1624 VJ-1638 VJ-2638	VJ-1638X VJ-1938X	VJ-1638W VJ-1624W VJ-1924W	VJ-1638WX VJ-1938WX VJ-1938WX-K4
Date and Time Update	O	O	O	O
Media Type Edit / User Type Edit	O	O	O	O
Firmware Update	O	O	O	O
Check current firmware	O	O	O	O
e-mail Notification	O	O	O	O
Color Verify *4	Δ*1	Δ*1	-	-
Status monitor	Printer Information	O	O	O
	Details Information	O	O	O
	Smart/C Information	Δ	Δ	Δ
	Head / Cartridge Information	O	O	O
	Heater Information	O	-	-
	S/C Card / Ink Information	O	O	O
	Media Information	-	-	-
Print Information	-	-	-	
MPS Start	Δ	Δ	Δ	Δ
VSM MobileÅ *2	O	O	O	O
Print History	-	O	-	O
Remote Panel	-	O	-	O
Printer Information Backup	O	O	O	O
Printer Information Upload	O	O	O	O

*1:Firmware Version : 1.09 or later version(VJ-1638 :2.01 , VJ-2638 :2.04 or later version)

*2:Application "VSM Mobile" for Handheld terminal is required.

*3:Firmware Version : 2.06 or later version(VJ-1638 / VJ-1638W / VJ-2638)

Refer to the VPS Operation Manual for details of VPS (ValueJet Print Server).

You can download the VPS Operation Manual from Mutoh Club.

*4 The printer model, which was launched after the EOL of VM-10, does not support this function.

Table 17.2. List of Functions Supported by MSM for Each Machine Model

○:Supported △: Limited Supported -: Not Supported

List of Supported Function		Machine Model			
		VJ-1628TD VJ-2628TD	VJ-1608HS VJ-1617H	RJ-900X RJ-901X	VJ-628 VJ-628X VJ-628MP
Date and Time Update		○	○	○ *5	○
Media Type Edit / User Type Edit		○	○	-	○
Firmware Update		○	○	○ *5	○
Check current firmware		○	○	○ *5	○
e-mail Notification		○ *1	○ *2	○ *5	○
Color Verify *7		-	△ *3	-	-
Status monitor	Printer Information	○	○	○	○
	Details Information	○	○	○	○
	Smart/C Information	△	△	-	△
	Head / Cartridge Information	○	○	○	○
	Heater Information	○	○	○	○
	S/C Card / Ink Information	○	○	○	○
	Media Information	-	-	-	-
	Print Information	-	-	-	-
MPS Start		-	-	-	-
VSM Mobile *4		○	○	○ *5	○
Print History		-	○	○ *5	○
Remote Panel		-	-	-	○
Printer Information Backup		○	○	○	○
Printer Information Upload		○	○	○	○

*1:Firmware Version : 1.08 or later version

*2:Firmware Version : 1.06 or later version(VJ-1608HS)

*3:Firmware Version : 2.00 or later version(VJ-1608HS)

*4:Application "VSM Mobile" for Handheld terminal is required.

*5:Support only LAN connection

*6:Support only USB connection

*7 The printer model, which was launched after the EOL of VM-10, does not support this function

Table 17.3. List of Functions Supported by MSM for Each Machine Model

○:Supported △: Limited Supported –: Not Supported

List of Supported Function		Machine Model		
		VJ-426UF VJ-626UF	VJ-1626UH	VJ-1628X
Date and Time Update		○	○	○
Media Type Edit / User Type Edit		○	○	○
Firmware Update		○	○	○
Check current firmware		○	○	○
e-mail Notification		○	○	○
Color Verify *2		–	–	△
Status monitor	Printer Information	○	○	○
	Details Information	○	○	○
	Smart/C Information	△	△	△
	Head / Cartridge Information	○	○	○
	Heater Information	–	–	○
	S/C Card / Ink Information	○	○	○
	Media Information	–	–	–
Print Information		–	–	–
MPS Start		–	–	○
VSM Mobile *1		○	○	○
Print History		○	○	○
Remote Panel		○	–	○
Printer Information Backup		○	○	○
Printer Information Upload		○	○	○

*1: Application "VSM Mobile" for Handheld terminal is required.

*2 The printer model, which was launched after the EOL of VM-10, does not support this function.

Table 17.4. List of Functions Supported by MSM for Each Machine Model

○:Supported △: Limited Supported –: Not Supported

List of Supported Function	Machine Model				
	VJ-1324X VJ-1324XS VJ-1624X	VJ-1624WX VJ-1924WX	VJ-2638X	VJ-1638UH VJ-1638UR	
Date and Time Update	○	○	○	○	
Media Type Edit / User Type Edit	○	○	○	○	
Firmware Update	○	○	○	○	
Check current firmware	○	○	○	○	
e-mail Notification	○	○	○	○	
Color Verify *2	△	–	△	–	
Status monitor	Printer Information	○	○	○	○
	Details Information	○	○	○	○
	Smart/C Information	△	△	△	△
	Head / Cartridge Information	○	○	○	○
	Heater Information	○	–	○	–
	S/C Card / Ink Information	○	○	○	○
	Media Information	–	–	–	–
	Print Information	–	–	–	–
MPS Start	–	–	○	○	
VSM Mobile *1	○	○	○	○	
Print History	○	○	○	○	
Remote Panel	○	○	○	○	
Printer Information Backup	○	○	○	○	
Printer Information Upload	○	○	○	○	

*1: Application "VSM Mobile" for Handheld terminal is required.

*2 The printer model, which was launched after the EOL of VM-10, does not support this function.

Table 17.5. List of Functions Supported by MSM for Each Machine Model

○:Supported △: Limited Supported -: Not Supported

List of Supported Function		Machine Model		
		VJ-1938TX	VJ-1948WX	VJ-1627MH
Date and Time Update		○	○	○
Media Type Edit / User Type Edit		○	○	○
Firmware Update		○	○	○
Check current firmware		○	○	○
e-mail Notification		○	○	○
Color Verify		-	-	-
Status monitor	Printer Information	○	○	○
	Details Information	○	○	○
	Smart/C Information	△	△	△
	Head / Cartridge Information	○	○	○
	Heater Information	-	○	○
	S/C Card / Ink Information	○	○	○
	Media Information	-	-	-
	Print Information	-	-	-
MPS Start		○	○	-
VSM Mobile *1		○	○	○
Print History		○	○	○
Remote Panel		○	○	○
Printer Information Backup		○	○	○
Printer Information Upload		○	○	○

*1: Application "VSM Mobile" for Handheld terminal is required.

Table 17.6. List of Functions Supported by MSM for Each Machine Model

○:Supported △: Limited Supported –: Not Supported

List of Supported Function		Machine Model		
		XPJ-1641SR XPJ-1641SR-P	XPJ-1682SR XPJ-1682SR-P	XPJ-1682WR
Date and Time Update		○	○	○
Media Type Edit / User Type Edit		○	○	○
Firmware Update		○	○	○
Check current firmware		○	○	○
e-mail Notification		○	○	○
Status monitor	Printer Information	○	○	○
	Details Information	○	○	○
	Smart/C Information	△	△	△
	Head / Cartridge Information	○	○	○
	Heater Information	○	○	–
	S/C Card / Ink Information	○	○	○
MPS Start		–	○	○
Print History		○	○	○
Remote Panel		○	○	○
Printer Information Backup		○	○	○
Printer Information Upload		○	○	○

Table 17.7. List of Functions Supported by MSM for Each Machine Model

○:Supported △: Limited Supported –: Not Supported

List of Supported Function		Machine Model	
		XPJ-461UF	XPJ-661UF
Date and Time Update		○	○
Media Type Edit / User Type Edit		○	○
Firmware Update		○	○
Check current firmware		○	○
e-mail Notification		○	○
Status monitor	Printer Information	○	○
	Details Information	○	○
	Smart/C Information	△	△
	Head / Cartridge Information	○	○
	Heater Information	–	–
	S/C Card / Ink Information	○	○
MPS Start		–	–
Print History		○	○
Remote Panel		○	○
Printer Information Backup		○	○
Printer Information Upload		○	○

Table 17.8. List of Functions Supported by MSM for Each Machine Model

○:Supported △: Limited Supported –: Not Supported

List of Supported Function		Machine Model
		VJ-1638UH2 VJ-1638UR2
Date and Time Update		○
Media Type Edit / User Type Edit		○
Firmware Update		○
Check current firmware		○
e-mail Notification		○
Color Verify		–
Status monitor	Printer Information	○
	Details Information	○
	Smart/C Information	△
	Head / Cartridge Information	○
	Heater Information	–
	S/C Card / Ink Information	○
	Media Information	–
	Print Information	–
MPS Start		○
VSM Mobile		–
Print History		○
Remote Panel		○
Printer Information Backup		○
Printer Information Upload		○

Table 17.9. List of Functions Supported by MSM for Each Machine Model

○:Supported △: Limited Supported -: Not Supported

List of Supported Function		Machine Model		
		XPJ-1642WR	VJ-1628MH	XJ-1341SR-P
Date and Time Update		○	○	○
Media Type Edit / User Type Edit		○	○	○
Firmware Update		○	○	○
Check current firmware		○	○	○
e-mail Notification		○	○	○
Status monitor	Printer Information	○	○	○
	Details Information	○	○	○
	Smart/C Information	△	△	△
	Head / Cartridge Information	○	○	○
	Heater Information	△*1	○	○
	S/C Card / Ink Information	○	○	○
MPS		○	-	-
Print History		○	○	○
Remote Panel		○	○	○
Printer Information Backup		○	○	○
Printer Information Upload		○	○	○

NOTE

*1 This function may not be available for some countries.

Table 17.10. List of Functions Supported by MSM for Each Machine Model

○:Supported △: Limited Supported -: Not Supported

List of Supported Function		Machine Model		
		XPJ-1341WR-P	XPJ-1462UF	HA-1642
Date and Time Update		○	○	○
Media Type Edit / User Type Edit		○	○	○
Firmware Update		○	○	○
Check current firmware		○	○	○
e-mail Notification		○	○	○
Status monitor	Printer Information	○	○	○
	Details Information	○	○	○
	Smart/C Information	△	△	△
	Head / Cartridge Information	○	○	○
	Heater Information	-	-	○
	S/C Card / Ink Information	○	○	○
MPS		-	-	-
Print History		○	○	○
Remote Panel		○	○	○
Printer Information Backup		○	○	○
Printer Information Upload		○	○	○

18. Error Code List

18.1. Printer Status

Status	No.	Description
Communication Err.	1	The communication with printer is not available. Please check the followings. 1. Make sure that the network cable is connected. 2. Make sure that the printer is on. 3. Make sure that the printer's IP address is correct.
	2	The communication with printer is duplicated. Please check the communication again.
	3	The acquisition of printer information failed. If the same error still persists, please contact the dealer.
	4	The printer's serial number is not registered yet. Please contact the dealer.
	5	The acquisition of printer information failed. Click 'Start' button. If the same error still persists, please contact the dealer.
Printer Info Update Err.	1 - 4	The acquisition of printer information failed. Please perform the followings. 1. Restart the printer. 2. Restart the MSM. If the problem still exists even you performed the items above, please contact the dealer.
	5	The temporary file for the printer information cannot be deleted. Please perform the followings. 1. Restart the Printer. 2. Restart the MSM. 3. Check the Tmp folder, and delete the file if exists. If the problem still exists even you performed the items above, please contact the dealer.
PrinterInfo acquisition Err.	1 - 8, 10-12.14	Could not acquire the printer information. Press 'Start' button to acquire the printer information again.
	9	The acquisition of printer information conflicted. Press 'Start' button to acquire the printer information again.
	13	The acquisition of printer information conflicted. Obtain the printer information again.

Status	No.	Description
PrinterInfo acquisition Err.	1 - 8, 10-12.14	Could not acquire the printer information. Press 'Start' button to acquire the printer information again.
	9	The acquisition of printer information conflicted. Press 'Start' button to acquire the printer information again.
	13	The acquisition of printer information conflicted. Obtain the printer information again.
	15 - 40	Printer Information Backup Failed. Could not obtain the printer information. Go to Printer Information Backup and try again.
Smart/C Update Err.	1 - 3	Could not update the Smart/C. Press 'Update' button to update the Smart/C.
	4	The update of Smart/C has been completed normally, but the initialization of Smart/C update log file failed. Please contact the dealer.
	5	Could not acquire the Smart/C from the server. Click 'Update' button to update the Smart/C again.
	6 - 8	Could not update the Smart/C. Check the type of Smart/C.
	9 - 10	Could not update the Smart/C. Cannot update the used Smart/C.
	11	Could not update the Smart/C. The limit of Smart/C update reached the maximum.
	12	Could not update the Smart/C. The Smart/C update is excessive in amount. Please update the Smart/C within the specified limit.
	13	Could not update the Smart/C. Press 'Update' button to update the Smart/C.
Cannot update until after login.	-	Cannot update the Smart/C without login. Please login to update the Smart/C.

Status	No.	Description
Printer Err.	1	The printer cannot be identified. Please check the followings. 1. Make sure that the serial number has been set correctly.
	2	The printer cannot be identified. Please check the followings. 1. Make sure that the printer has been registered.
	3	The acquisition of printer information failed. If the same error still persists, please contact the dealer.
	4	The printer's serial number is not registered yet. Please contact the dealer.
	5	The acquisition of printer information failed. Click 'Start' button. If the same error still persists, please contact the dealer.
	6	The printer cannot be identified. Please check the followings. 1. Make sure that the activation mode is correct (PR).
	7 - 8	The printer cannot be identified. Please check the followings. 1. Make sure that the printer model supports the MSM.
Printer Err. : Serious Failure	xxx	The system error occurred. Make sure 1. the printer runs properly. For details, please see the operation manual of the printer. If the same error still persists, please contact the dealer.
	71 , 73	The system error occurred. Make sure 1. the media is properly loaded to the printer. If the error still persists, the printer may have been damaged. Please contact your dealer.
	72 , 74	The system error occurred. Make sure 1. the media is properly loaded to the printer. 2. there is no obstacle on the platen. If the error still persists, the printer may have been damaged. Please contact your dealer.
	76	The system error occurred. Make sure 1. the Voltage Selector Switch is set to the correct voltage for your region. If the error still persists, the printer may have been damaged. Please contact your dealer.
Printer Err. : AC Shut Down	-	Restart the Printer.
Printer Err. : CPU Error		If the same error still persists, please contact the dealer.

Status	No.	Description
F/W Installation Mode	-	Restart the Printer.
MSM Err.	1	Unspecified Error. If the MSM is the old version, install the latest version.
	2	No printer has been registered. Please register the printer.
	3	There is no file required for the operation. Please re-install the MSM.
Activation required.	-	The activation has not been executed. The printing cannot be performed without the activation.
	-	Since you don't have the control right, the activation cannot be executed. Acquire the control right, or execute the activation by the MSM that has the control right. The printing cannot be performed without the activation. Please execute the activation.
Activation Code get error	-	Could not acquire the activation code. Execute the activation again. If the same error still persists, please contact the dealer.
Activation Err.	1	Could not acquire the activation information, so the registration is not available. Perform the registration again. If the same error still persists, please contact the dealer.
	2	The activation failed. The printer registration and the printing are not available without the activation. Execute the activation again. If the same error still persists, please contact the dealer.
	3	Could not acquire the activation information, so the registration is not available. Perform the registration again. If the same error still persists, please contact the dealer.
	4	Could not acquire the activation code. Restart the printer, Execute the activation again.
	5 - 7	Could not execute the activation. Execute the activation again.
	8	Could not execute the activation. The activation code is incorrect. Make sure that the activation code is appropriate for the target printer. If the same error still persists, please contact the dealer.

Status	No.	Description
Login error	-	Could not login to the server. Please check the followings. 1. Make sure that the Internet access is available. 2. Make sure that the ID and password are correct.
WebServer Err.	-1	The MSM version may be old.
	-100	Please use the latest MSM.
	-200	Could not login to the server.
	-220	Please check the ID and password.
	-300	The issuance of Smart/C or Activation Code failed. Please update again.
	-310	The server is in the maintenance status. Please try again later.
	-320	Cannot update the Smart/C due to the lack of Smart/C. Please contact the dealer.
	-330	Could not acquire the Smart/C or activation code from the server. Please contact the dealer.
	-360	There is no Smart/C available. Please contact the dealer.
	-380	exceeds the upper limit to use the Smart/C
	-400	Cannot connect to the server. Please check the following 1. Connection Setting 2. Internet Connection Setting
-500	Cannot connect to the server Please contact the dealer.	

18.2. Printer Registration

Status	No.	Description
Communication Err.	1	The communication with printer is not available. Please check the followings. 1. Make sure that the network cable is connected. 2. Make sure that the printer is on. 3. Make sure that the printer's IP address is correct.
	2	The acquisition of printer information conflicted. Please try again later.
	3	The acquisition of printer information failed. If the same error is repeatedly displayed,, please contact the dealer.
	4	The printer's serial number is not registered yet. Please contact the dealer.
	5	The acquisition of printer information failed. If the same error is repeatedly displayed, please contact the dealer.
Printer Info Update Err.	1 - 8	Could not acquire the printer information.
	10 - 12	The printer information again.
	9	The acquisition of printer information conflicted. Please try again later.
Control right Err.	1	Could not update the control right due to the update of Smart/C. After the update of Smart/C is completed, update the control right.
	2 - 3,	Could not update the control right.
	5	Please try again later.
	4	The control right is duplicated. Could not acquire the control right, since other MSM acquires the control right.

Status	No.	Description
Printer Change Err.	1 - 2	This printer is different from the registered printer, so the registered content for the printer cannot be changed. Please register the printer as another printer.
	3	Unable to change. Please register this printer.
Printer Registration Err.	1 - 2	The target printer is already registered, so the registration is not available.
	3 - 4 6 - 8	The activation succeeded, but the acquisition of printer information failed, so the printer was not registered to the server and MSM.
	5	The initialization of printer information file failed. There is no problem with the activation and the printer registration.
	9	The MSM is previous version. Please use the latest version.
Printer Err.	1	The printer cannot be identified. Please check the followings. 1. Make sure that the serial number has been set correctly.
	2 - 4	The printer cannot be identified. Please check the followings. 1. Make sure that the printer has been registered.
	5	The printer cannot be identified. Please check the followings. 1. Make sure that the activation mode is correct (BM).
	6	The printer cannot be identified. Please check the followings. 1. Make sure that the activation mode is correct (PR).
	7 - 8	The printer cannot be identified. Please check the followings. 1. Make sure that the printer model supports the MSM

Status	No.	Description
Activation required.	-	The activation has not been executed. The printing cannot be performed without the activation. Please execute the activation.
		Since you don't have the control right, the activation cannot be executed. Acquire the control right, or execute the activation by the MSM that has the control right. The printing cannot be performed without the activation. Please execute the activation.
Activation Code get error	-	Could not acquire the activation code. Execute the activation again. If the same error is repeatedly displayed, please contact the dealer.
Activation Err.	1,3	Could not acquire the activation information, so the registration is not available. Perform the registration again. If the same error is repeatedly displayed, please contact the dealer.
	2	The activation failed. The printer registration and the printing are not available without the activation. Execute the activation again. If the same error is repeatedly displayed, please contact the dealer.
	4	Could not execute the activation. Restart the printer, Execute the activation again.
	5 - 7	Could not execute the activation. Execute the activation again.
	8	Could not execute the activation. The activation code is incorrect. Make sure that the activation code is appropriate for the target printer. If the same error is repeatedly displayed, please contact the dealer.

Status	No.	Description
WebServer Err.	-1	If the MSM is the old version, install the latest version.
	-100	
	-200	Could not login to the server.
	-220	Please check the ID and password.
	-300	Could not acquire the activation code. Execute the activation again.
	-310	The server is in the maintenance status. Please try again later.
	-320	Could not acquire the activation code. Execute the activation again.
	-400	Cannot connect to the server. Please check the following. 1. Connection Setting 2. Internet Connection Setting
	-500	Cannot connect to the server. Please contact the dealer.
MSM Err.	1	Unspecified Error. If the MSM is the old version, install the latest version.
	2	No printer has been registered. Please register the printer.
	3	There is no file required for the operation. Please re-install the MSM.

18.3. Remote Panel

No.	Description
-1	A communication error occurred between PC and the printer. Check the connection between the PC and the printer, and then click 'Update' again.
-2	The old version of MSM or firmware might be installed. Update MSM and firmware to the latest versions.
-3	The old version of MSM or firmware might be installed.
-4	Update MSM and firmware to the latest versions.
-10	Unable to switch to remote panel mode. Currently, the printer is operated from the printer operation panel. Please wait until the panel operation is complete.
-11	Another MSM Mobile is in operation. Please wait until another user finishes operating the printer.
-12	Remote Panel Mode is not activated. Acquire the control right.
-13	Timeout error. Please try again later.
-20	Data printing. Please wait until the printer completes the printing.
-21	The printer cannot execute the instructions from the remote panel. Please check the printer status.
-22	The printer is in sleep mode. Wake the printer from sleep mode and try again.
-23	The printer is executing the instruction from the remote panel. Please check the printer status.
-24	Unable to execute the instruction from the remote panel while the printer is not printing. Please check the printer status.
-100	Unsupported Function. Update MSM and the firmware to the latest versions.
-401	A communication error occurred between PC and the printer. Restart MSM and the printer.

18.4. Smart/C

18.4.1 S/C Card

Status	No.	Description
Read Error	-	Cannot read the S/C card. Insert and remove the S/C card.
No S/C card exists.	-	The S/C card is not inserted. Insert the S/C card.
No card reader exists.	-	The S/C card reader is not connected. Connect the S/C card reader. If the same error still persists, please contact the dealer.
Card Reader Duplication	-	Multiple S/C card reader are connected. Make sure to connect only one S/C card reader.
Invalid S/C card	1, 3 - 6	This S/C card is already used. Insert a new S/C card. If the same error still persists, please contact the dealer.
	2, 7 - 10	This S/C card does not support the printer. Insert the S/C card that supports the printer. If the same error still persists, please contact the dealer.

Status	No.	Description
Smart/C Update Err	1 - 5	A communication error occurred between PC and the printer. Update the Smart/C again.
	6 - 8,19	This S/C card does not support the printer. Insert the S/C card that supports the printer. If the same error still persists, please contact the dealer.
	9 - 10	This S/C card is already used. Insert a new S/C card. If the same error still persists, please contact the dealer.
	12	That will exceed the maximum Smart/C capacity. Replace with the S/C card that has sufficient free space to charge the credits you specified.
	13	Unspecified Error. If the MSM is the old version, install the latest version.
	14	The S/C card was removed while updating. Insert the S/C card that supports the printer.
	15	This S/C card does not support the printer. Insert the S/C card that supports the printer.
	16	The S/C card was replaced while updating. Do not replace the card while updating.
	17 - 18	Check that the latest device driver for the S/C card reader is installed. If the same error still persists, please contact the dealer.

MUTOH